Up and Running: A REAPER User Guide v 7.31

Version 7.31
February 2025

This guide will be updated regularly as the software itself is further improved and developed.
Check for updates and other information at
<http://www.cockos.com/reaper/>

This document has been produced, compiled and rendered to PDF format using the wonderful **LibreOffice Writer** software.

For more information about **LibreOffice** go to <https://www.libreoffice.org/>

How to Use This Guide

REAPER is a complex program and there is no single obvious or easy way or order to present all of the information contained in this guide. If you need more information about any topic than appears on any particular page, try searching! The PDF edition is bookmarked, and your PDF reader includes a *Find* or *Search* feature on its toolbar. Also, both the PDF and printed editions include an index.

Note: The **What's New In This Edition** summary can now be found on **Page 13**.

© Geoffrey Francis, 2008-2024, All rights reserved

Not to be republished or replicated in whole or in part in any format, including electronic format, without my expressed permission.

For a bound hard copy of the latest version of this User Guide (printed in B&W) go to [LULU.com](https://www.lulu.com)

ReaRead: REAPER books and training manuals printed and spiral bound are now available from <http://www.lulu.com/spotlight/glazfolk>

Up and Running: A REAPER User Guide

The essential and definitive guide to recording, editing and mixing with REAPER. Fully updated for each dot version. Includes sample project files and step by step examples to help you learn how to use many features of REAPER. Includes special sections on routing and audio channel splitting, as well as numerous examples of how to use and apply many of the supplied FX plug-ins.

"*Up and Running* is not only a comprehensive guide to using REAPER, it's also full of an amazing amount of information on audio recording and engineering. I simply cannot recommend it enough!" - **Justin Frankel** (COCKOS Inc and REAPER Developer).

ReaMix: Breaking the Barriers with REAPER

This book does much more than just teach you how to use basic tools (such as volume, panning, EQ, gates, compressors, delay, reverb etc.) to get an OK mix. It also guides you thru the relationships – some simple, some complex – that exist between the dimensions of sound and the dimensions of space to transform your OK mixes into great mixes. Although not light on theory, it has a definite practical emphasis, with links to archives containing some 40 or so project files, with step by step examples to help you put your knowledge into practice.

"Wow! So much good stuff - from mindbending advanced techniques to solid sensible advice. This guide should have a positive effect on just about anybody interested in mixing (and especially those using REAPER)!" - **Justin Frankel**, Cockos Inc, developer of REAPER.

REAPER Web Resources

The REAPER project is a live, dynamic and ongoing one. Be sure to check these web sites often:

<http://www.cockos.com/reaper/>

<http://www.cockos.com/reaper/download.php>

<http://www.cockos.com/reaper/about.php>

<http://www.cockos.com/forum/forumdisplay.php?f=20>

<http://www.cockos.com/wiki/>

The REAPER Home Page

The REAPER Downloads Page

REAPER Features summary

The REAPER Forums

The REAPER Wiki

Sample Project Files

These are available for download from http://www.cockos.com/wiki/index.php/REAPER_User_Guide

The links are case sensitive. After unzipping the files, follow the instructions in README.txt to install. The media files are in .MP3 format. Some of the examples outlined in this book require recording further tracks in MP3 format. In order to be able to do this, you will need to have an MP3 encoder installed in your REAPER program directory. The Lame encoder included in the REAPER install package will by default be installed there.

Acknowledgements

Much thanks goes out to the many people who have assisted with or contributed to the production of this guide over the last dozen years or so. There are so many of you that that if I was to attempt to list names I'd be sure to miss some out! Thank you very much – you know who you are!

Disclaimer

This document is intended to introduce you to REAPER and to assist you in learning and understanding how to use this software. It is not, nor is it intended to serve as, a 100% comprehensive encyclopaedic repository of every detail, every aspect or every application of all of REAPER's many, many features.

This User Guide is not intended to serve as a comprehensive generic and universal guide to the world of digital audio. If you feel you need a better understanding of the meaning of terms like bit, byte, amplitude, fast fourier transformation (FFT), and so on, you can post your questions on the REAPER forums, or find your answers by searching the internet.

Contents

1	Setting Up and Getting Started.....	15
1.1	Downloading REAPER.....	15
1.2	Installing REAPER on a MacOS.....	15
1.3	Installing REAPER on a Windows PC.....	15
1.4	The Install Options (Windows only).....	16
1.5	REAPER's Default Settings and Preferences.....	16
1.6	REAPER Software Updates.....	17
1.7	Starting REAPER.....	17
1.8	REAPER Startup Tips.....	17
1.9	REAPER Selections, Controls and Commands.....	17
1.10	The REAPER Screen.....	18
1.11	The Track and Track Controls.....	19
1.12	Setting Up For Audio.....	20
1.13	Input Aliasing.....	21
1.14	Output Aliasing.....	21
1.15	Setting Up For MIDI.....	22
1.16	VST, CLAP and LV2 Plug-ins.....	23
1.17	REAPER's Installed Folders and File Location.....	24
1.18	Localization and Language Packs.....	26
1.19	Backing Up Settings.....	26
1.20	Running REAPER on a Flash Drive.....	26
1.21	REAPER Start Menu Options (Windows only).....	27
1.22	REAPER File Types.....	28
1.23	User License Information.....	28
1.24	Pops and Clicks.....	28
1.25	Uninstalling REAPER.....	28
2	REAPER Project Basics.....	29
2.1	Opening an Existing Project.....	29
2.2	Project Settings.....	30
2.3	The Transport Bar.....	32
2.4	Using the Track Controls.....	33
2.5	Pan Law and Pan Mode.....	34
2.6	Navigation and Zooming.....	34
2.7	The Visual Track Spacer.....	36
2.8	Directing Audio and MIDI Output.....	36
2.9	Using the Navigator.....	36
2.10	Track FX Basics.....	37
2.11	Using the Supplied FX Presets.....	38
2.12	Controlling Track FX.....	38
2.13	FX Window and Keyboard Shortcuts.....	40
2.14	Using an FX Bus.....	41
2.15	Managing the Play Cursor.....	42
2.16	Analyzing FX Performance.....	43
2.17	Time Selections and Time Loops.....	44
2.18	Managing Time and Loop Selections.....	44
2.19	Navigating by Jumping.....	45
2.20	Time and Loop Selections and the Transport Bar.....	46
2.21	REAPER Routing Essentials.....	46
2.22	Showing Sends in the Track Panel.....	47
2.23	The Routing Matrix.....	47
2.24	Managing Tracks.....	48
2.25	Keeping a Window on Top.....	49
2.26	The Track Wiring View.....	49
2.27	Docking and Floating.....	51

Up and Running: A REAPER User Guide v 7.31

2.28	The Undo History Window.....	51
2.29	Multiple Project Tabs.....	52
2.30	Item Names, Buttons and Icons.....	53
2.31	Online and Offline Media Items.....	53
2.32	Advanced Track Settings.....	53
2.33	Reset REAPER to Factory Defaults.....	53
2.34	The Big Clock.....	54
3	Recording Audio and MIDI.....	55
3.1	Creating a New Project.....	55
3.2	Setting Media Project Options.....	56
3.3	Saving the Project File.....	56
3.4	Creating and Naming Tracks.....	57
3.5	To Prepare and Record One Track.....	57
3.6	To Prepare and Record Multiple Tracks.....	58
3.7	Auto Arming Tracks.....	59
3.8	Using the Metronome.....	59
3.9	Recording Stereo Tracks.....	60
3.10	Multi-Channel Recording.....	60
3.11	Track Templates.....	61
3.12	Importing an Existing Project.....	61
3.13	Project Templates.....	61
3.14	Layered Recording.....	62
3.15	Overdubbing and Punch Recording.....	62
3.16	Non-Destructive Punch Recording.....	63
3.17	Destructive Punch Recording.....	64
3.18	Fades and Crossfades.....	64
3.19	Recording Multiple Takes.....	64
3.20	Displaying Multiple Takes.....	65
3.21	Using Color Coded Takes.....	65
3.22	Working With Multiple Takes.....	66
3.23	Overlapping Items.....	66
3.24	Recording Multiple Additional Items.....	67
3.25	Recording with Empty Events.....	67
3.26	Recording with Input FX Plug-ins.....	68
3.27	Input Monitoring without Recording.....	68
3.28	Preserve PDC Delayed Monitoring in Recorded Items.....	68
3.29	Recording a Track's Output.....	69
3.30	Recording FX Bus Output.....	69
3.31	Recording MIDI.....	69
3.32	Other MIDI Recording Modes.....	71
3.33	Recording With a Virtual Instrument.....	71
3.34	Using Microsoft GS Wavetable SW Synth.....	72
3.35	Looped Overdubbing and Looped Time Selection Recording.....	72
3.36	Recording with External Hardware FX.....	73
3.37	Preference Settings for Recording.....	74
3.38	Track Preferences for Recording.....	75
3.39	Other Track Recording Settings.....	75
3.40	REAPER Audio Recording Checklist.....	76
3.41	Recording MIDI From Keyboard Checklist.....	76
3.42	Recording an Internet Audio Stream.....	77
3.43	Converting Audio Media Item Format.....	77
3.44	Recording Live Windows Output.....	78
4	Managing Media: The Media Explorer.....	79
4.1	Introduction and Overview.....	79
4.2	Media Explorer Basics.....	80
4.3	File Management.....	81

For a bound hard copy of the latest version of this User Guide (printed in B&W) go to LULU.com

4.4	Working With Metadata.....	82
4.5	Creating and Using Databases.....	82
4.6	Media Item Preview.....	83
4.7	Inserting Audio Files, Samples and FX.....	85
4.8	Import Media File Types.....	88
4.9	Importing REAPER Project Files.....	88
4.10	Previewing and Importing MIDI Files.....	88
4.11	Media Explorer Options and Other Actions.....	89
5	Project Arrangement Basics.....	91
5.1	Managing Tracks.....	91
5.2	Track Control Modifiers.....	92
5.3	Mute/Solo In Front.....	93
5.4	Auto-Naming Multiple Tracks.....	93
5.5	Searching the Preferences Settings.....	93
5.6	Track Colors.....	94
5.7	Track Icons.....	94
5.8	Track Meter Options.....	94
5.9	Track Layouts.....	95
5.10	Displaying Grid Lines.....	95
5.11	Headphone Monitoring and Headphone Mixing.....	95
5.12	Understanding Sends, Buses, Submixes and Folders.....	96
5.13	Track Folder Essentials.....	97
5.14	Track and Track Parameter Grouping.....	100
5.15	Temporary Track Grouping without the Grouping Matrix.....	104
5.16	VCA Grouping.....	105
5.17	Track Group Management from the Track Panel.....	106
5.18	The Main Toolbar.....	107
5.19	Animated Toolbar Icons.....	107
5.20	Track Layout Options.....	108
6	Managing Track and Item FX.....	109
6.1	Grouping FX in Folders.....	109
6.2	Using Boolean Search Filters.....	110
6.3	FX Browser Options.....	111
6.4	Item Take FX.....	111
6.5	Managing FX: Tips and Tricks.....	112
6.6	Controlling FX from the TCP.....	113
6.7	Managing FX Parameters.....	113
6.8	Serial vs Parallel FX Chains.....	114
6.9	Duplicate Plug-in Priorities.....	114
6.10	Advanced Plug-in Defaults.....	115
6.11	Advanced Floated FX Window Options.....	115
6.12	Embedding FX GUI in TCP or MCP.....	116
6.13	Hardware Output FX Monitoring.....	116
6.14	Optimizing FX Performance.....	116
6.15	Plug-in Delay Compensation.....	116
6.16	Opening a File in Recovery Mode.....	117
6.17	Freezing and Unfreezing Tracks.....	117
6.18	The JS Analysis Loudness Meter.....	118
6.19	VST and VST3 FX Compatibility Settings.....	118
6.20	Missing Items.....	119
6.21	Installing Extra JS Plug-ins.....	119
6.22	ReaEffects User Guide Supplement.....	119
6.23	Audio Signal Flow Chart: Master Track.....	119
6.24	Audio Signal Flow Chart: Tracks and Folders.....	120
7	Managing and Editing Media Items.....	121

Up and Running: A REAPER User Guide v 7.31

7.1	Using an External Editor.....	121
7.2	Editing Media Items in REAPER.....	121
7.3	Power Editing with Mouse Modifier Overrides.....	124
7.4	Auto Trim/Split Items.....	126
7.5	Media Item Editing with Track Group Items.....	126
7.6	Simple Item Grouping.....	131
7.7	Storing and Recalling Item Groups.....	131
7.8	Media Item Properties.....	132
7.9	Media Item Appearance Preferences.....	133
7.10	Editing Behavior Preferences.....	134
7.11	Overlapping Media Items.....	134
7.12	Separating Loop Selection from Time Selection.....	134
7.13	Slip Editing.....	134
7.14	Insert Space in Selection.....	135
7.15	Trim Behind When Editing.....	135
7.16	Creating and Copying Items in Pencil Mode.....	136
7.17	Propagating Items.....	136
7.18	Implode Items To One Track.....	137
7.19	Ripple Editing.....	137
7.20	Trim to Selected Area.....	138
7.21	Item Mute and Solo Actions.....	138
7.22	Displaying the Item Ruler.....	139
7.23	Take Media Source.....	139
7.24	Normalizing Items.....	139
7.25	Snapping with Combined Snap/Grid Settings.....	139
7.26	Separate Snap and Grid Settings.....	140
7.27	Free Item Positioning.....	140
7.28	The Nudge/Set Items Window.....	141
7.29	Item Channel Mode and Channel Mapping.....	142
7.30	Adjusting Media Item Fades.....	142
7.31	Crossfades and the Crossfade Editor.....	143
7.32	Calculating Item Loudness.....	145
7.33	Glue Selected Items.....	145
7.34	Coloring Individual Items.....	146
7.35	Customising Mouse Modifiers.....	146
7.36	Dynamic Splitting - Remove Silent Passages.....	148
7.37	Item Peak Display Basics.....	149
7.38	Normal Peaks and Spectral Peaks: Display Basics.....	150
7.39	Spectrogram View and Spectral Editing.....	152
7.40	Advanced Features – Loudness Unit Full Scale Modes.....	154
8	Managing, Comping and Editing Takes.....	155
8.1	Using Item FX with Individual Takes.....	155
8.2	Exploding Takes to Multiple Tracks.....	155
8.3	Crossfades with Takes.....	156
8.4	Exploding Takes in Place.....	156
8.5	Play All Takes.....	156
8.6	Editing and Comping Multiple Takes and Multiple Tracks.....	156
8.7	Take Menu Command Summary.....	158
8.8	Propagating Takes.....	159
8.9	More Take Commands and Actions.....	159
8.10	Managing Comps with the Project Bay.....	160
8.11	Item Take Markers.....	160
8.12	Comping with Ranked Take Markers.....	161
8.13	Fixed Media Item Lanes.....	163
9	Loops, Project Markers and Regions.....	169
9.1	Creating Loops.....	169

9.2	Creating and Navigating with Project Markers.....	170
9.3	Time Selection Start/End Markers.....	171
9.4	Snapping to Markers.....	171
9.5	Removing Markers.....	172
9.6	Show/Hide Regions/Markers in Grid.....	172
9.7	Marker Actions.....	172
9.8	Creating and Using Regions.....	173
9.9	The Region/Marker Manager.....	174
9.10	Overlapping Regions.....	175
9.11	Project Building with Regions.....	175
9.12	Markers and Media Cues.....	176
9.13	Changing the Project Timebase.....	176
9.14	Tempo Based Music Production.....	177
9.15	Embedding Transient Information when Rendering.....	179
9.16	Quantizing Items.....	180
9.17	Dynamic Splitting.....	180
9.18	Ruler Layout Options.....	183
9.19	REX and Similar File Support.....	184
10	Pitch and Time Manipulation.....	185
10.1	Changing the Project Play Rate.....	185
10.2	Changing Pitch for Individual Media Items.....	185
10.3	Using the ReaPitch Plug-in.....	186
10.4	Using ReaPitch with Multiple Tracks.....	187
10.5	Time Stretching.....	187
10.6	Pitch Correction with ReaTune.....	188
10.7	Stretch Markers.....	188
10.8	Time Signature/Tempo Changes and Markers.....	191
10.9	Timeline Display: Negative Timecodes.....	192
10.10	Playback Time Offset with Routing.....	193
10.11	Audio Jogging and Scrubbing.....	193
10.12	REAPER Integration with ARA.....	194
11	The Mixer and The Master.....	197
11.1	Introduction.....	197
11.2	Alternative Mixer Layouts.....	199
11.3	Tweaking the Mixer Display.....	199
11.4	Managing Parent/Child Tracks.....	200
11.5	Working with FX in the Mixer.....	201
11.6	Working with Sends in the Mixer.....	202
11.7	VU Meters on Multichannel Tracks.....	203
11.8	Track Control Functions.....	204
11.9	Stereo Panning and Dual Panning.....	204
11.10	Master Track Options and Settings.....	206
11.11	Master Hardware Outputs.....	207
11.12	Master Track Channels.....	207
12	Managing The Overall Project.....	209
12.1	Introduction.....	209
12.2	Project Timebase, Time Signature and Related Settings.....	209
12.3	Crop to Selection and Remove Contents of Selection.....	209
12.4	Project Lock Settings.....	210
12.5	The Theme Development Tweaker.....	211
12.6	The Project Media/FX Bay.....	211
12.7	The Track Manager.....	216
12.8	Track View Screen Sets.....	218
12.9	Windows Screensets.....	219
12.10	Auto Saving Screen Sets.....	220

Up and Running: A REAPER User Guide v 7.31

12.11	Creating a Text Track.....	220
12.12	Item Selection Sets.....	221
12.13	Track, Mixer, Transport and Envelope Layouts.....	221
12.14	Moving Track Panel Position.....	222
12.15	Play/Stop Cursor Options.....	222
12.16	SWS Extensions.....	222
12.17	Using FX Parameter MIDI Learn.....	222
12.18	Track Templates Revisited.....	223
12.19	Track Control Panel and Menu Bar Help.....	224
12.20	Associating Rendered WAV Files with Source Project Files.....	224
12.21	Multiple Project Backup Versions.....	224
12.22	Using Multiple Dockers.....	224
12.23	Saving New Project Versions.....	226
12.24	Projects and Subprojects.....	226
12.25	Working with Multiple Instances of REAPER.....	230
13	Working with MIDI Items.....	231
13.1	Introduction.....	231
13.2	Monitoring an External Synthesizer.....	231
13.3	Using Track Controls with MIDI.....	231
13.4	Controlling MIDI Data Sends.....	231
13.5	Configuring and Accessing the MIDI Editor.....	232
13.6	The MIDI Editor Window.....	232
13.7	Control Change Messages.....	235
13.8	Control Change Basics.....	236
13.9	MIDI Editor CC Lanes.....	237
13.10	MIDI CC Lanes: Tips & Tricks.....	239
13.11	Navigating the MIDI Editor Main Window.....	240
13.12	Basic Note Selection and Manipulation.....	240
13.13	Loop/Time Selections and Smart Editing.....	241
13.14	The MIDI Editor Menus.....	241
13.15	Note Creating and Editing.....	246
13.16	Using the Keyboard.....	247
13.17	Transposing Notes.....	248
13.18	General MIDI Program Patches.....	248
13.19	MIDI Preview Scrub.....	248
13.20	F3 - The Panic Button.....	248
13.21	MIDI Editor Modes and Views.....	249
13.22	Arrange View MIDI Processing Options.....	250
13.23	Quantizing MIDI Data.....	251
13.24	Input Quantization.....	252
13.25	Humanize Notes.....	253
13.26	Step Recording.....	253
13.27	Working with Multiple MIDI Tracks and/or Items (Overview).....	254
13.28	Managing Multiple MIDI Tracks and Items.....	255
13.29	Optimizing MIDI Editor Workflow.....	256
13.30	Editing Multiple MIDI Items.....	256
13.31	MIDI Editor Mouse Modifiers.....	257
13.32	MIDI Editor Actions.....	257
13.33	MIDI Output Direct to an External Synth.....	259
13.34	In-Line MIDI Editing.....	260
13.35	Copying MIDI Items in Arrange View.....	260
13.36	Joining MIDI Items.....	261
13.37	MIDI Preferences Settings.....	262
13.38	Exporting Project MIDI.....	262
13.39	MIDI Routing, MIDI Buses and ReWire.....	262
13.40	ReaControlMIDI.....	263

13.41	Some MIDI Plug-ins.....	263
13.42	MIDI Controlled Pitch Shift with ReaVoice.....	264
13.43	The Scale Finder.....	265
13.44	MIDI Item Source Properties.....	266
13.45	Feedback Routing with MIDI Tracks.....	266
13.46	Working with Piano Roll Synced to Project Arrange View.....	266
13.47	Sequencer Megababy.....	266
13.48	Using MIDI CC Messages to Control FX Presets.....	268
13.49	Custom MIDI Note and CC Names.....	269
13.50	Recording and Routing thru MIDI Channels.....	269
13.51	Retroactive MIDI Recording.....	270
14	Music Notation and REAPER's Notation Editor.....	271
14.1	A Brief Introduction to Notation.....	271
14.2	REAPER's Notation Editor: a First Look.....	272
14.3	Opening MIDI Items in the Notation Editor.....	274
14.4	REAPER's Notation Editor: A Closer Look.....	274
14.5	Notation Editor View Options.....	275
14.6	Basic Note Selection and MIDI Editor Tasks.....	276
14.7	Notation Editor Specific Tasks and Functions.....	277
14.8	Working with Notes and Note Selections.....	284
14.9	Editing Notation Events in Other Views.....	288
14.10	Exporting MusicXML and PDF Files.....	288
14.11	XML Import.....	288
14.12	Making a Notation Editor Toolbar.....	288
15	Customization: Actions, Mouse Modifiers, Menus and More.....	289
15.1	Introduction.....	289
15.2	REAPER Actions Essentials.....	289
15.3	The Action List Editor Environment.....	290
15.4	The Actions List Context Menu.....	292
15.5	Creating a New Keyboard Shortcut.....	292
15.6	Global Shortcut Overrides.....	293
15.7	Removing a Shortcut or Changing a Key Assignment.....	293
15.8	Action List Sections.....	294
15.9	Deprecated Actions.....	295
15.10	Keyboard Shortcuts for Recording.....	295
15.11	Keyboard Shortcuts for the MIDI Editor.....	295
15.12	Keyboard Shortcuts for FX and FX Chains.....	296
15.13	Assigning Actions to the Mousewheel.....	296
15.14	Exporting and Importing Key Maps.....	297
15.15	Creating Custom Action Macros.....	297
15.16	Importing and Loading Scripts.....	298
15.17	Introducing ReaPack.....	298
15.18	Meta Actions.....	299
15.19	Mouse Modifiers.....	299
15.20	Saving and Restoring Mouse Modifier Settings.....	301
15.21	MIDI Editor Mouse Modifiers.....	301
15.22	Customizing the REAPER Menus.....	303
15.23	Customizing the REAPER Toolbars.....	305
15.24	Additional Custom Toolbars.....	308
15.25	Displaying a Toolbar as a Menu.....	309
15.26	Smart Tools and Armed Actions.....	309
15.27	The Toolbar Docker.....	310
15.28	Toolbar Appearance Preferences.....	310
15.29	Using a Control Device with REAPER.....	311
15.30	Controlling REAPER with a Web Browser Interface.....	313
15.31	Customizing Track Panel Area Width.....	314

15.32	Reset VU Meter Peaks.....	314
15.33	The Theme Adjuster (Overview).....	314
16	REAPER Plug-ins in Action.....	315
16.1	What Are Plug-ins?.....	315
16.2	Five Types of Plug-in.....	315
16.3	Adjusting Plug-in Parameter Controls.....	315
16.4	Sound Shaping Effects: ReaEQ.....	316
16.5	Time Based Effects: Delay.....	317
16.6	Analytical Plug-ins: the Frequency Spectrum Analyzer Meter.....	318
16.7	The JS Master Limiter and ReaLimit.....	318
16.8	Using FX Presets.....	319
16.9	Volume Control with Compression: ReaComp.....	319
16.10	Volume Control with a Noise Gate.....	321
16.11	Time Based Effects: ReaVerb.....	321
16.12	Noise Reduction with ReaFir.....	323
16.13	Multiband Compression with ReaXComp.....	324
16.14	ReaLimit: The Brickwall Limiter.....	325
16.15	ReaTune Revisited.....	326
16.16	JS Plug-Ins and ReaPack: an Overview.....	326
16.17	Summary Examples of JS Plug-In Categories.....	327
16.18	Bridging and VST Plug-in Run Mode.....	327
16.19	Controlling FX Parameters on the Fly.....	328
16.20	Sending FX Output to a Different Track.....	328
16.21	Third Party Plug-in Presets.....	328
16.22	FX and FX Chain Options.....	328
17	More Routing Examples.....	329
17.1	Understanding REAPER's Channel Routing.....	329
17.2	The Track Routing Button.....	329
17.3	Send and Receive Types.....	329
17.4	Pin Connectors and Channel Mapping.....	329
17.5	Sidechaining and Audio Ducking.....	330
17.6	FX Containers and Parallel FX Processing.....	331
17.7	Sending FX Output to Another Track.....	334
17.8	Other Channel Routing/Mixing Plug-ins (Overview).....	334
17.9	Further VSTi Signal Routing.....	334
17.10	Round-Robin Multisampling.....	335
17.11	ReaSamplomatic and ReaDrums.....	335
17.12	REAPER's Routing Interface.....	337
17.13	Surround Panning with ReaSurround and ReaSurroundPan.....	338
17.14	Routing to/from Other Applications with ReWire.....	342
17.15	MIDI Routing and MIDI Buses.....	343
17.16	Multichannel Parent-Child Relationships.....	345
17.17	Multi Output VSTi Plug-ins.....	346
18	Automation – Envelopes and More.....	347
18.1	Understanding Automation.....	347
18.2	The Track Envelopes Window.....	347
18.3	Automation Envelope Methods.....	348
18.4	Available Track and Send Envelopes.....	348
18.5	Writing Automation.....	348
18.6	Envelope Points Options.....	349
18.7	Writing Mute Automation.....	350
18.8	Automation Modes.....	350
18.9	Latch Preview Mode.....	351
18.10	Global Automation Override.....	352
18.11	Envelope Panel and Track Menu Controls.....	352

18.12	The Track Envelopes Window Revisited.....	353
18.13	The Envelope Manager.....	354
18.14	Manually Editing Envelopes.....	355
18.15	Using the Mouse with Envelopes.....	356
18.16	Managing Automation Envelope Display.....	356
18.17	Envelope Shapes.....	357
18.18	Envelope Edit Mouse Modifiers.....	358
18.19	The Envelope Panel Controls.....	358
18.20	Managing and Manipulating Envelopes.....	359
18.21	Envelope Preferences.....	360
18.22	Using an Envelopes Toolbar.....	360
18.23	Moving and Copying Envelopes with Items.....	360
18.24	Copying Points From One Envelope to Another.....	361
18.25	Automation with Trim Volume Envelopes.....	361
18.26	Locking Envelopes.....	362
18.27	Automation with Grouped Track Parameters.....	362
18.28	Automation of FX Parameters.....	362
18.29	Automation of Container FX Parameters.....	362
18.30	FX Automation: Learn Mode.....	363
18.31	Automating a VST with MIDI CC Messages.....	363
18.32	Automating FX Parameters on the Fly.....	363
18.33	Automation with Item Take and Take FX Parameters.....	363
18.34	Automation with Hardware Output Sends.....	364
18.35	Automating the Metronome.....	365
18.36	Tempo/Time Signature and Play Speed Envelopes.....	365
18.37	More Envelope Tips.....	366
18.38	Razor Editing with Automation Envelopes.....	366
18.39	Automation with Hardware Output Sends.....	368
18.40	Automation Items.....	368
19	Parameter Modulation and Automation Tips.....	373
19.1	The Concept.....	373
19.2	The Interface.....	373
19.3	Defining a Parameter for Modulation.....	374
19.4	Defining a Parameter for Modification.....	376
19.5	Parameter Modulation with Audio Control.....	376
19.6	Using an LFO Shape with Parameter Modulation.....	378
19.7	Using Parameter Modulation for Dynamic Compression.....	379
19.8	Bypass Mode.....	380
19.9	Parameter Modulation Under Parameter Control.....	380
19.10	Using Parameter Modulation with an Envelope.....	381
19.11	Parameter Modulation under Sidechain Audio Control.....	382
19.12	Using MIDI Links for Parameter Modulation.....	383
19.13	Parameter Modulation from Plug-in Parameters.....	385
19.14	Further Applications.....	386
19.15	Managing FX Parameters in the Project Bay.....	386
19.16	Automation and Envelope Tips.....	387
20	Using REAPER with Video.....	389
20.1	Simple Video Editing.....	389
20.2	Video Effects.....	391
20.3	Working with Multiple Video Tracks.....	392
20.4	Video Processor Parameter Controls.....	396
20.5	Supplied Video Effects Presets.....	396
20.6	Understanding Video Formats.....	397
20.7	REAPER Video Processing Tips.....	397
20.8	REAPER Video Settings and Preferences.....	398
20.9	Video Workflow Tips.....	399

Up and Running: A REAPER User Guide v 7.31

20.10 Making a Home Music Video on a Budget.....	400
21 Exporting Files, Mixing Down and Rendering.....	401
21.1 Introduction.....	401
21.2 Consolidating and Exporting.....	402
21.3 Rendering A Project.....	403
21.4 Dry Run Render Stats and Options.....	405
21.5 Render to File: Source Options.....	407
21.6 Project Rendering Examples.....	407
21.7 Rendering a Finished Song.....	408
21.8 Rendering a Group of Tracks to a Single Track.....	408
21.9 Queued File Rendering.....	409
21.10 Rendering Regions.....	409
21.11 Batch File/Item Converter.....	411
21.12 Burning an Audio CD with REAPER.....	412
21.13 Saving Live Output to Disk.....	414
21.14 Surround Rendering.....	415
21.15 Rendering a Video Project.....	415
21.16 Stem Rendering Media Items.....	416
22 REAPER's Preferences and Other Settings.....	417
22.1 Introduction.....	417
22.2 General Preferences.....	417
22.3 Main Project Preferences.....	419
22.4 Audio Configuration and Settings.....	422
22.5 Audio Glitches and Related Issues.....	423
22.6 Audio Preferences.....	424
22.7 Appearance Preferences.....	427
22.8 Editing Behavior Preferences.....	432
22.9 Media Preferences.....	437
22.10 Plug-ins Preferences.....	438
22.11 Project and File Management.....	440
22.12 Customizing the Performance Meter.....	441
22.13 Customizing Undo History Behavior.....	441
22.14 Custom UI Tweaks (PC).....	442
22.15 Custom UI Tweaks (Mac).....	442
23 Using REAPER with Other Applications and Devices.....	443
23.1 Introducing ReaRoute (PC Only).....	443
23.2 Setting Up Applications for ReaRoute.....	443
23.3 Sending Audio from REAPER to Another Application.....	444
23.4 Sending Audio From Another DAW App to REAPER.....	444
23.5 Using REAPER With a Synth Workstation.....	444
23.6 Syncing to an External Device.....	445
23.7 Generating and Sending Timecode.....	445
23.8 REAPER as Client to MIDI Sequencer Software.....	446
23.9 ReaScript.....	446
23.10 NINJAM.....	447
Appendix: Troubleshooting REAPER.....	449
Index.....	455

What's New In This Edition

The table below summarizes the *main* feature changes introduced in the most recent REAPER updates. It may include features that were previously undocumented, but not bug fixes, performance improvements and minor changes. See the official REAPER changelog for full details (Help, Changelog).

Main Changes in 7.20 (August 2024)

Preferences: various changes to MIDI setup preferences.....[Page 22](#)

Main Changes in 7.23 (September 2024)

Metronome: option for project grid to follow the metronome pattern.....[Pages 59-60](#)

Metronome: options to save, recall, rename, delete sample presets.....[Pages 59-60](#)

Track groups: up to 128 track groups supported.....[Page 100](#)

Normalize: various item processing improvements and additional options.....[Page 139](#)

Render: option to normalize media items/regions when rendering not through master.....[Page 139](#)

Peaks display: more display combinations available.....[Page 150](#)

Peaks display: opacity control slider added to dialog.....[Page 151](#)

Ruler: context menu commands added to set/reset project start time or start measure.....[Page 209](#)

Menu customization: ability to copy, move or delete several commands together[Page 303](#)

Automation: adding envelopes for container FX parameters.....[Page 362](#)

Render to file: many enhancements to dry run options.....[Page 405](#)

Render to file: options to include razor edit areas as source.....[Page 407](#)

Envelopes: preferences options to set envelope point scaling.....[Page 428](#)

Normalize: preference option for normalize actions to affect all takes in media item.....[Page 432](#)

Automation preferences: specify behavior if pre fx/post fx envelopes are both armed.....[Page 434](#)

MIDI editing: preferences to avoid setting MIDI items on non-playing lanes visible.....[Page 436](#)

Main Changes in 7.25 (October 2024)

Rendering: options following output format options rearranged and increased.....[Page 405](#)

Main Changes in 7.26 (October 2024)

Customization: actions added to display custom toolbar as a menu.....[Page 309](#)

Rendering: more option buttons added to rendered file display window.....[Page 405](#)

Main Changes in 7.27 (November 2024)

Actions: action added to dry run render project using most recent settings.....[Page 406](#)

Rendering: option to prevent render window to reopen modelessly after render finishes.....[Page 427](#)

Main Changes in 7.28 (December 2024)

LUFDS peak display settings: some minor interface changes.....[Page 154](#)

Dry run rendering: various actions added to dry run render from arrange view.....[Page 405](#)

Automation preferences: new preference to record at playback or processing position.....[Page 434](#)

Main Changes in 7.29 (December 2024)

Editing: split items at nearest prior zero crossing.....[Page 122](#)

Render to file dialog: checkbox option to enable/disable normalize/fade settings.....[Page 403](#)

Batch file converter: major changes to interface, including imploding/exploding channels.....[Page 411](#)

Project preferences: option to specify wildcard pattern to be used with File, Save as.....[Page 419](#)

Appearance preferences: separate pages for media items and medial item buttons.....[Page 429](#)

Appearance, Media item buttons preferences: option to show if phase is inverted[Page 429](#)

Main Changes in 7.31 (February 2025)

Project settings: support project settings for BPM basics (quarter, dotted quarter. Etc).....[Page 30](#)

Transport bar: right click on tempo for menu to change beat basis.....[Page 32](#)

Track grouping: context menu options to group/ungroup tracks for razor editing.....[Page 106, 123](#)

Main toolbar: Ripple edit options added.....[Page 107](#)

Main toolbar: Envelope points options added.....[Page 107](#)

How To Search This PDF Guide

This document is optimised for use with PDF-Xchange Editor, Adobe or Foxit. Internal document hyperlinks are available: click on the hyperlink to jump straight to that part of the document, then use **Alt Left-Arrow** to return to where you were.

Most PDF readers allow you to search this (and other) PDF documents. My personal preference is for **PDF-Xchange Editor**, which has remarkably powerful and flexible search options. For users of Adobe, detailed instructions can be found here: <https://helpx.adobe.com/acrobat/using/searching-pdfs.html> That page includes various further links, including one to Advanced **Search Options**, including:

Press **Ctrl F** to open a simple search window which enables you to find a word or exact phrase. For example, type **reacomp** and press enter to find the first occurrence of reacomp. Two arrows will be displayed to enable you to move thru the document to the next or previous occurrence. This is not case sensitive.

Similarly, you could search for **automation envelopes** or **ctrl alt r** to find either of those phrases. Simple search, however will only find exact matches. For example, a search for **track color** would find track color or track colors or track coloring, but not color track

That's where advanced search comes in handy. Press **Ctrl Shift F** to open the Advanced Search Window

(shown on the far right). This will find and list in its context every instance of your search string. An example – after searching for *reaverb* - is shown here (immediate right). Thus, you are able to jump straight to any one of them.

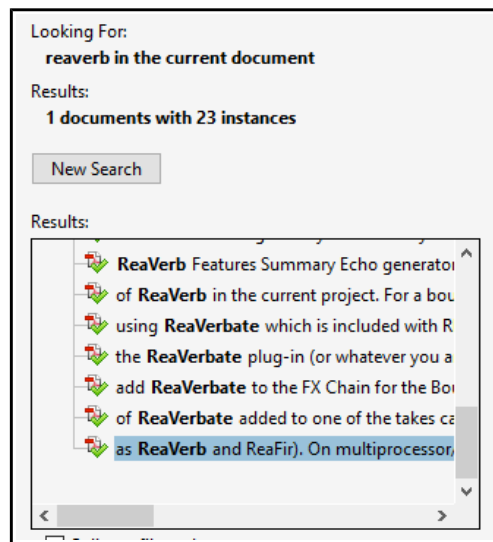

Advanced Search has many more features than can

be detailed here: indeed, the link at the start of this section leads to what is virtually a manual in its own right! However, in overview, click on **Show more options** or (depending on which Adobe version you are using) **Use advanced search options** (at foot of window) to enable a whole assortment of options, including.

- ◆ **Match any of the words.** For example, type **color tint** to find all occurrence of color or tint, and their derivatives (e.g. colors, tinting).
- ◆ **Whole words only** to exclude derivatives (e.g. to find **reaverb** but not **reaverbate**), and **Case sensitive** to force case sensitivity.
- ◆ **Match exact word or phrase**, for example to find **frequency spectrum** only when both words occur together.

Other supported features include boolean searches, although for this feature to be available you need to select the directory where your PDF is stored (rather than Current Document) from the Look In drop down. To learn more about these and other features, including **Search preferences**, follow the link at the start of this section.

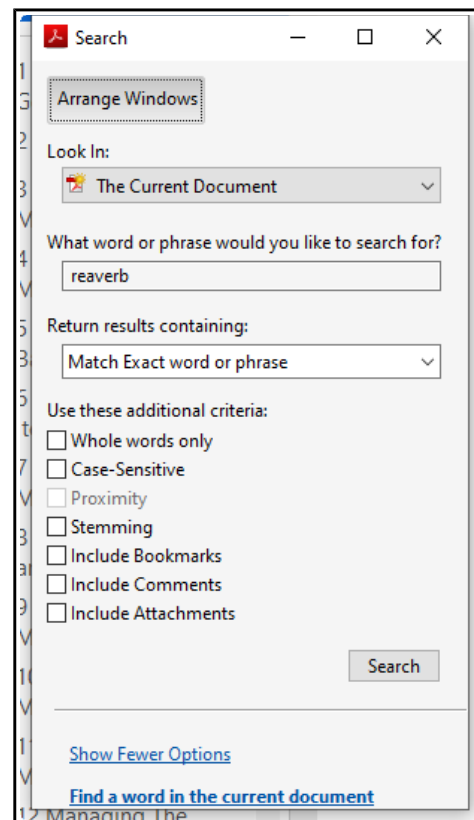

Note: With REAPER's rapid rate of development, this edition may not be 100% up to date. For a full list of new and recent features, choose the **Help, Changelog** command from the REAPER menu. To check for the latest versions of both REAPER and this User Guide, go to <http://www.cockos.com/reaper/download.php>

Setting Up and Getting Started

1 Setting Up and Getting Started

1.1 Downloading REAPER

To download REAPER, visit the download page <http://www.cockos.com/reaper/download.php>. Read the on-screen information carefully (especially about 32 bit and 64-bit) and be sure to select the correct version for your computer. If you keep the program for more than 60 days then you must purchase a license. To purchase your REAPER license, go to <http://www.cockos.com/reaper/purchase.php>

After downloading you will need to install the program. There are differences in the installation process for MacOS (Mac) and for Windows (PC).

1.2 Installing REAPER on a MacOS

To install REAPER on a Mac (MacOS) follow this procedure.

1. Double-click on the REAPER disk image (.dmg) file to open it.
2. If you agree to accept the licence conditions, click on **Agree** to open this file.
3. Drag and drop the REAPER icon (shown right) into your **Applications** folder.

To pin REAPER to the dock, simply drag and drop the REAPER icon from the Applications folder on to the Dock. We strongly recommend that you should also, under **System Preferences**, ensure that for your **Mouse** right click is enabled as a secondary button.



1.3 Installing REAPER on a Windows PC

To install REAPER on a PC with Windows you should follow this sequence:

1. In Windows Explorer, find the install file. The file name includes the current version number, e.g. **reaper70-install.exe**.
2. Double click on this file to start the install program.
3. Click the **I Agree** button to accept the conditions and continue.
4. For a normal install, accept the default folder offered to you (but see note below) - for example, **C:\Program Files\REAPER (x64)**.
5. If you need to, enable the **Portable install** option (see note below), then click **Next**.
6. Select which elements you wish to install (if in doubt accept the default settings - see also section 1.4 below) and click on **Install**.
7. Wait while the program installs. When prompted, click on **Close** to close the Install program. You will be asked if you wish to run the program now: in this case, choose **No**.
8. Follow any other on-screen instructions.

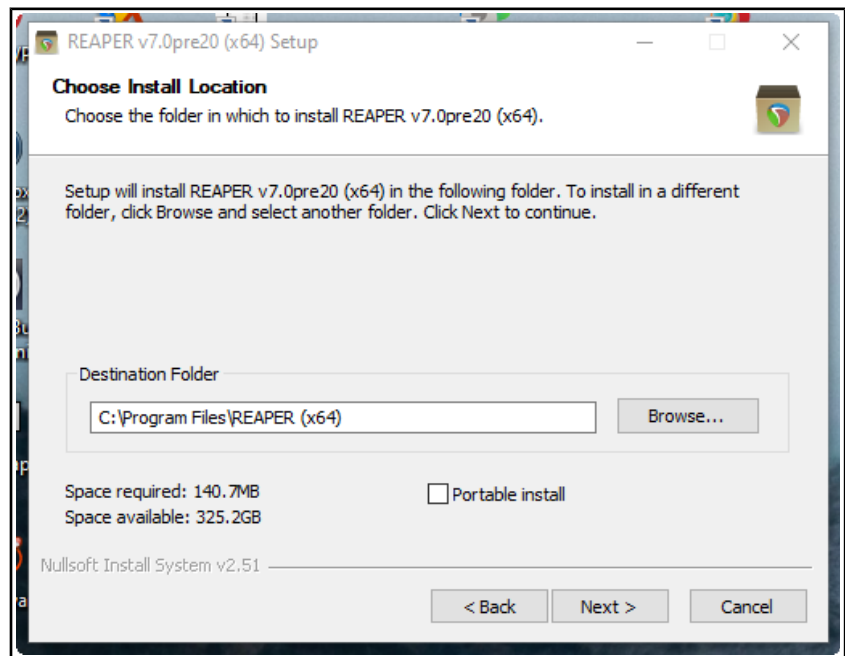

Up and Running: A REAPER User Guide v 7.31

Note: If you are installing REAPER for the first time, or if you wish to replace an existing installed version of REAPER with this one, you should accept the default destination folder and not enable portable install. If you wish to install this alongside an existing installed version (such as 6.xx), then you should change the destination directory (e.g. to \REAPER7) and enable portable install. This will ensure that your existing settings and preferences will be preserved separately.

Tip: If you choose not to install some of the REAPER program elements or options, you can later change your mind by simply running the install program again.

1.4 The Install Options (Windows only)

The Install screen lets you decide which REAPER elements you choose to install and which ones you prefer not to install. Listed below is a summary of your main options. By default, most of them are enabled.

Item	Explanation
Required files	These are the files that REAPER needs to perform effectively. You have no choice but to install these.
Optional Functionality	<p>ReaWire ReaRoute ASIO driver These options enable REAPER's various advanced routing capabilities, such as controlling the passing of audio/MIDI material between REAPER and other programs. If you choose not to install these, you can reinstall REAPER to add them at any time in the future.</p> <p>Configure Windows to save REAPER crash dumps. This option causes diagnostic information to be saved in the event of REAPER crashing. By default this option is set to off.</p>
Desktop Icon	Leaving this option selected ensures that a REAPER shortcut icon will be placed on your Windows desktop.
Start Menu Shortcuts	Leave this option ticked to ensure that REAPER is added to your Windows Start Menu.
Associate with RPP Files	Ticking this option will enable you to open REAPER with any of your REAPER Project files direct from Windows Explorer or any desktop shortcut that you might create for your projects.

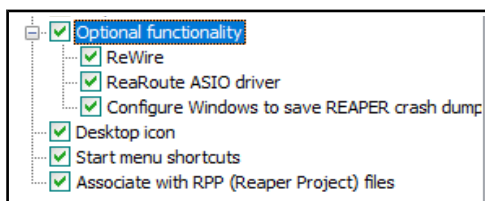

1.5 REAPER's Default Settings and Preferences

Throughout this guide you will find frequent references to various preferences and settings that help determine REAPER's behavior.

- If you are installing REAPER on your computer for the first time, the default settings and preferences described throughout this document will be applied.
- If you are installing REAPER over the top of, and replacing, an earlier version of REAPER, your existing settings and preferences will be ported across to the new installation.

For example, for a brand new installation of REAPER 7, the REAPER 7 default color theme will be selected. However, if you are installing it over an earlier version, such as REAPER 6.xx, then your previously selected theme will be applied. You could change this using the **Themes** command from the **Options** menu.

Setting Up and Getting Started

1.6 REAPER Software Updates

REAPER is updated frequently with bug fixes, new features and other enhancements. You can check for updates at any time by visiting <http://www.reaper.fm/> Simply download and install. There is no need to first uninstall any previous version. Existing preferences and settings will automatically be carried over.

Tip: An option is available under **Options, Preferences, General** (Startup Settings) to have REAPER automatically check for updates each time the program is started. By default, this option is enabled. If you do not wish to be notified whenever a new version is available, you can disable it.

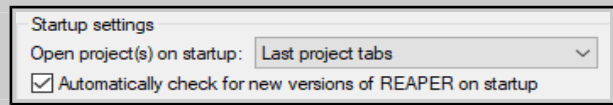

1.7 Starting REAPER

To start REAPER, just double click on the REAPER desktop icon. You might also wish to consider creating a keyboard shortcut for this. For Windows users, this is done using the **Shortcut** tab of the icon's **Properties** dialog box. Right-click over the icon to display this.



Tip: If REAPER fails to open but instead returns an error message then this is most likely because of an issue with a third party plug-in. Try opening it using either of the methods described below (section 1.8).

1.8 REAPER Startup Tips

By default, REAPER opens with the last used project. As you will see in Chapter 22 ([Preferences, General](#)), you can disable this behavior. Also, you can use hot keys when starting REAPER to override the default behavior:

Action	Booster Key(s)
Open REAPER without loading last project.	Shift (while starting REAPER)
Open REAPER without loading any default project template.	Ctrl Shift (while starting REAPER)
Open REAPER without scanning new/updated VST plugins.	Ctrl (while starting REAPER).

1.9 REAPER Selections, Controls and Commands

Working in REAPER involves making selections and giving commands. For example, to copy a single item you would select the item (usually using your mouse) and then give the command for REAPER to copy it. Other times, you will use commands that affect the whole project file without any selection. For example, you might wish to save all your work. In that case, there would be no need to select anything – you would only need to give the necessary command. There are four main methods commonly used to give commands in REAPER:

Method	Comment									
The Main Menu	As with other applications, this is accessed by the mouse or keyboard.									
Context Menus	Click your right mouse button over an item or area of the screen to display a context menu relevant to where you have clicked.									
Toolbars	Click your mouse on any toolbar button for its command to be executed.									
Keyboard Shortcuts	Many commands and actions can be accessed by keyboard shortcuts. You can also assign your own shortcuts to other commands and actions. Chapter 15 explains this. In some cases, different modifier keys are used for the PC and for the Mac. The examples used throughout this guide are PC (Windows) shortcuts. Mac users should refer to the summary table of similarities and differences shown below:									
	<table border="1"><thead><tr><th>PC (Windows) Key</th><th>Mac (MacOS) Key Equivalent</th></tr></thead><tbody><tr><td>Shift</td><td>Shift</td></tr><tr><td>Control (Ctrl)</td><td>Command (Cmd)</td></tr><tr><td>Alt</td><td>Option</td></tr><tr><td>Windows</td><td>Control</td></tr></tbody></table>	PC (Windows) Key	Mac (MacOS) Key Equivalent	Shift	Shift	Control (Ctrl)	Command (Cmd)	Alt	Option	Windows
PC (Windows) Key	Mac (MacOS) Key Equivalent									
Shift	Shift									
Control (Ctrl)	Command (Cmd)									
Alt	Option									
Windows	Control									

Up and Running: A REAPER User Guide v 7.31

1.10 The REAPER Screen

REAPER allows you to select from a number of different color themes. The screen shots used in this book mostly use the REAPER 7 default theme.

When you start REAPER, it displays a screen similar to that shown below. We have added (for illustration) a simple project file with two tracks. A first time installation will not show this. The table below the illustration introduces briefly each of the main screen elements.

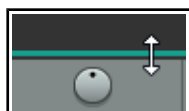
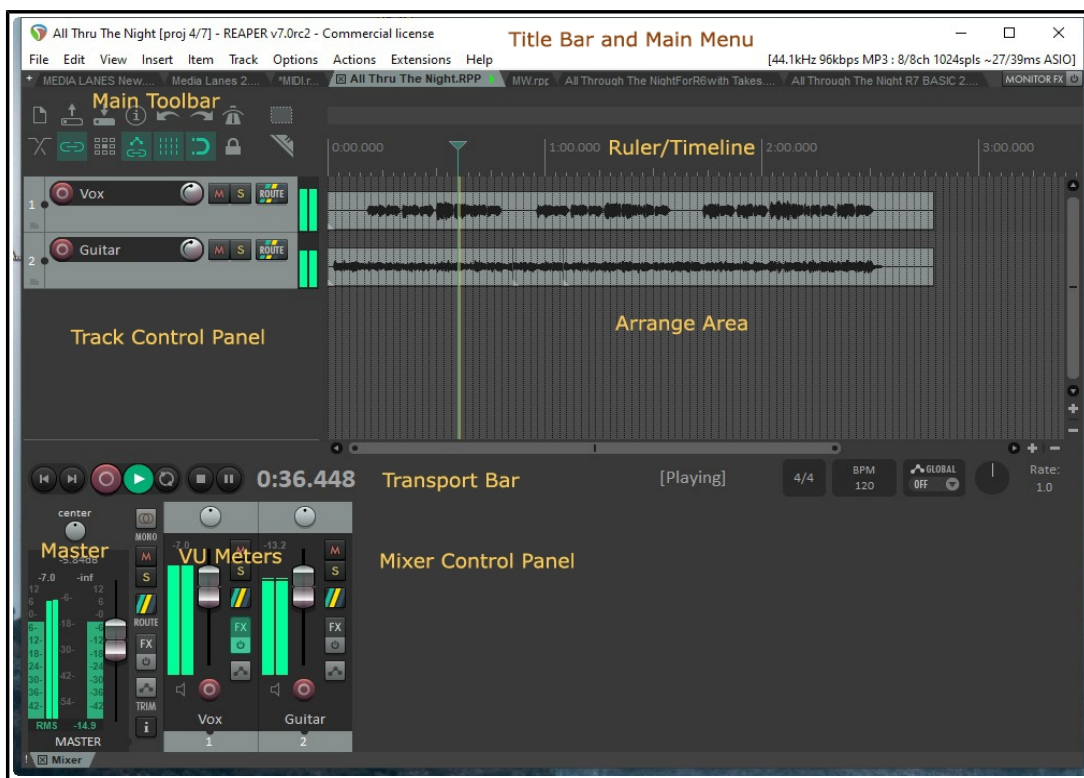

Note: You can adjust the boundary between the arrange view and the mixer view so as to allocate screen space between the two as you wish. Hover the mouse over the border between the mixer and the transport bar to display a vertical double-headed arrow across a light blue line. You can then drag the boundary up or down as you wish.

Element	Explanation
The Menu Bar	This displays the Main Menu near the top as a row of commands – File, Edit, View, Insert, Item, Track and so on. As in other Mac and Windows applications, the menu is used to give commands.
The Main Toolbar	Just below the menu are two rows of buttons. This is the REAPER Main Toolbar. You can hover your mouse over any button to obtain a tooltip (see example, left). Some of the tools might appear animated. Don't worry about this for now. The various icons are introduced and explained throughout this guide as they are needed, and summarized at the end of Chapter 5 . In Chapter 15 you will be shown how you can customize this toolbar .
The Ruler/Timeline	The timeline (or ruler) runs across the top of the REAPER window, to the right of the main toolbar. It measures the length of your project and helps you identify the position of the various media items. In the example shown, the timeline is measured and displayed in both measures/beats and minutes/seconds.
The Track Control Panel (TCP)	This area controls the behavior of your audio and MIDI tracks – in this example there are two tracks. You can have as many tracks as you need.

For a bound hard copy of the latest version of this User Guide (printed in B&W) go to LULU.com

Setting Up and Getting Started

Element	Explanation
The Arrange Area: Main Window and Workplace!	To the right of the TCP, this contains a track's media items (audio and/or MIDI and/or video). In this example, there are two tracks each containing one media item .
The VU Meters	These Volume Unit Meters give a visual indicator of the level of the track's audio signal strength (volume). These are visible in both the TCP and the Mixer.
The Transport Bar	This is used to control recording and playback – for example, to start and stop recording. We'll look at this in Chapter 2 .
The Mixer and Mixer Control Panel (MCP)	This is shown at the bottom of the screen, displaying the same tracks in a different way. This also includes a Master output track. The output of the Master is what you hear when you play your tracks and media items. Mixer and Master display options will be explored in detail in Chapter 11 .

Don't be surprised if your screen doesn't look quite the same as this, or even if it looks considerably different. The REAPER screen can be customized to suit your individual needs. We'll be covering this in [Chapter 2](#).

1.11 The Track and Track Controls

This illustration shows REAPER's track controls. Their exact position may vary according to factors such as the track height and the track control panel width. Note that Record input and Input source are only visible when Record arm is enabled.

By default, not all of these controls will be visible in the TCP when you first start REAPER. This is because both the Arrange View and the Mixer are shown.

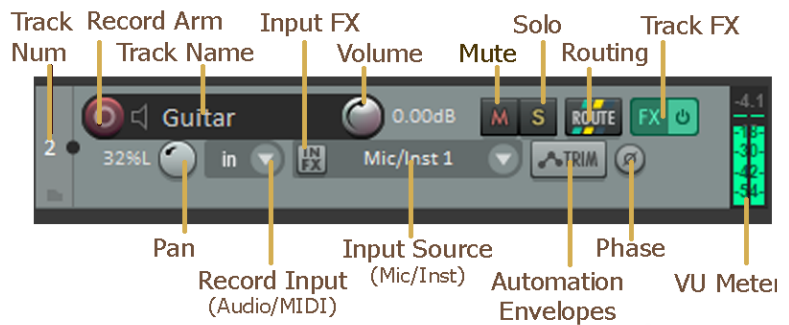

Since all controls are shown in the mixer (below right) many users prefer not to show all of them in the TCP. The default mixer and track panel layouts are dynamically linked: if you close the mixer (**Ctrl M**), all controls will then become visible in the track panel. Reopen the mixer (**Ctrl M**) and some track controls will again be hidden.

Especially if you are working on a laptop, or have only one monitor, in order to be able to make the best use of screen space you might wish to keep the mixer open only when you are needing to use it.

You can hover your mouse over any control for a tooltip. You click on a control to engage it (for example, click on the Mute button to toggle mute status of any track, click and drag on the Volume control to adjust the volume level), and right click on a control for a menu of commands, options and/or settings.

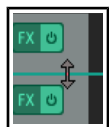

Some controls might not be visible if the track panel is not large enough to show them all. If so, you may need to increase the track panel height or width. Hover your mouse over the appropriate boundary (see left) so that your cursor becomes a double headed arrow, then click-drag to the right or downwards. To increase the

height of all tracks, press **PgUp**.



Depending on track layout, the volume control may be a rotary (as shown here) or a horizontal fader. All controls will be explained further as you work thru this guide.

Note: By default, the volume and pan controls work with audio items, not MIDI. To change this for any track(s), choose **MIDI track controls, Link track volume/pan to all MIDI channels** from the right-click menu.

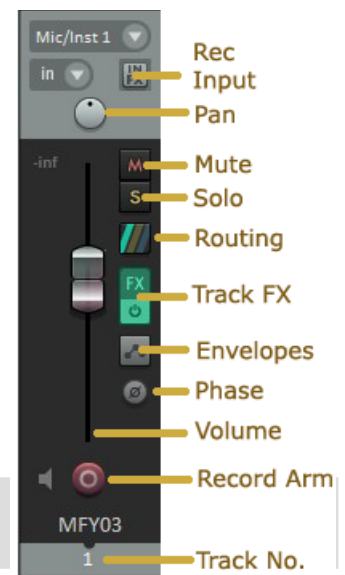

1.12 Setting Up For Audio

Before you can record or play anything you will need to set up your audio preferences. This is needed to tell REAPER which audio device(s) you have, and how you wish to use them. There are differences in how you should do this for a Mac under MacOS and a PC under Windows. It is also advisable to disable **System Sounds**. For MacOS users, this is done in System Preferences. Windows users should use the Control Panel.

Even if you work exclusively with MIDI, you will need to set up audio to enable (for example) metronome sounds and to use synths to play back your MIDI material.

1.12.1 Setting Up For Audio (PC Windows)

To set up your Audio Device, first choose **Options, Preferences** from REAPER's Main Menu, then under **Audio** select **Device**.

If using the PC's internal sound card, get to know its control software (opened from the Windows Control Panel). This can prevent previously recorded material from being mixed back in and re-recorded with new material when new tracks are overlaid. If your sound card includes its own ASIO drivers then these are usually preferred. On the Audio Device Preferences screen, you should set the following options:

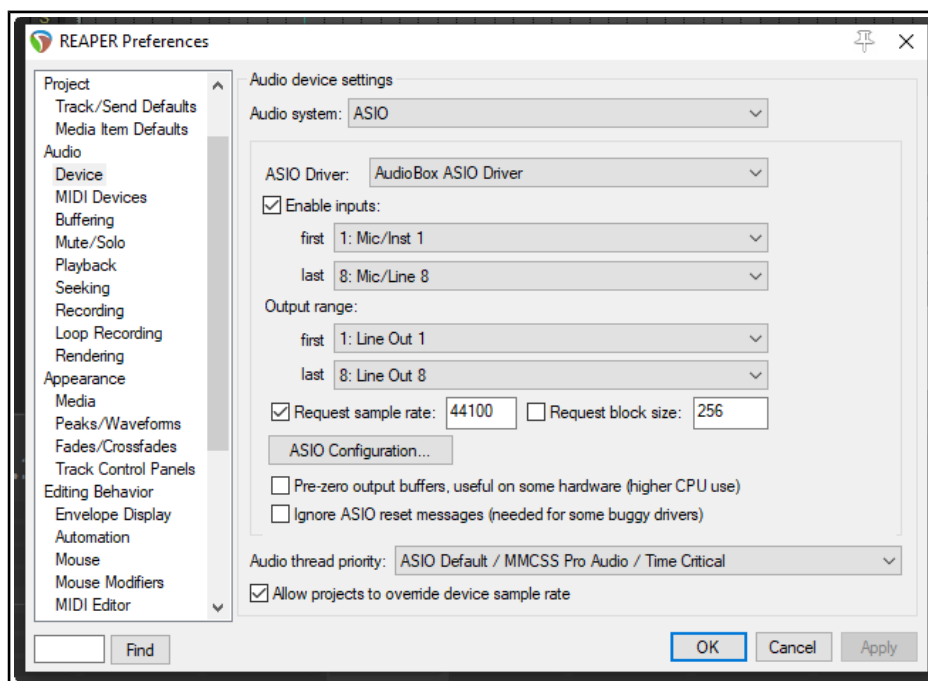

Item	Comment
Audio System	The other items on this screen will vary with the audio system selected. Choose ASIO and ASIO drivers if they are available for your sound card or Firewire or USB device. Otherwise, WASAPI or WaveOut will usually give better performance than will the Direct Sound setting: you might need to set WASAPI to Exclusive mode .
Enable Inputs	This option needs to be turned on (ticked) if you wish to use REAPER for recording.
Input Range	If your device has multiple inputs (up to 512), specify the first and last that you want to be available. In this example, eight inputs are available, allowing up to eight microphones or lines (in any combination) to be used simultaneously for recording.
Output Range	If your device has multiple outputs (up to 512), specify the first and last that you wish to be available. Usually, your MASTER bus will direct output to a single pair of outputs, but you can use the others also if you wish.
Request sample rate/block size	Tick these to set sample rate and block size for your audio device here (generally preferred), or leave these blank if you wish to use your sound card's own control software to set these. If unsure, start with 44100 and 512.
ASIO Configuration	If your sound card/audio device uses ASIO drivers, then clicking this button will give you direct access to the control software for your sound card/audio device.
Audio Thread Priority	Assigning a higher priority will ensure that audio threads will be processed ahead of other threads (e.g. graphics).

Setting Up and Getting Started

1.12.2 Setting Up For Audio (MacOS)

Audio devices on the MacOS are set up and selected in the MacOS **Audio MIDI Setup**. Make sure you have first downloaded and installed the latest Mac updates. You should also check your Audio Device in REAPER. To do this, start REAPER and choose the **Options, Preferences** command from REAPER's Main Menu, then under **Audio** select **Device** from the list of headers in the column on the left.

In the first example shown below, a USB Saffire device (a Focusrite Saffire Pro 40) has been installed. Saffire has therefore been selected so as to ensure that this device is used for both input and output. You can (as shown here) set the sample rate and block size (which helps determine latency) here, or you can independently open the device's own control panel and set them there. If unsure, set these at 44100 and 512 to begin with.

If using the Mac's internal sound card, you need to prevent existing material being mixed back into, and re-recorded with, any tracks that are added later.

To do this, you will need an aggregate device. Open the OS X **Audio MIDI Setup** then click on the **+** in the bottom left corner of the window to create such a device. Add to this aggregate device the built in input and built in output as shown here. If you wish to rename it, double click on the text **Aggregate Device**.

Next, in REAPER's **Audio, Device** preferences screen, select your aggregate device and **Apply** your changes. You will now be able to use your headphones with the computer's audio out socket and your microphone with its audio in socket. Using an aggregate device can also resolve routing issues which can arise if using built-in inputs and outputs.

1.13 Input Aliasing

REAPER supports **Input Aliasing**. This is the ability to give your own names to your audio inputs. It can be used to shorten the long names that the system will often give to these inputs, especially when your device supports multiple inputs. An example of the use of this feature might be to change names like **Analog In 1 Delta 1010 (1)**, **Analog In 2 Delta 1010 (1)** and so on to just **Mic/Line 1**, **Mic/Line 2**, etc.

Input Aliasing is accessed from the **Audio Preferences** screen. Select **Input Channel Name Aliasing/Remapping**. The method is similar to that used for output aliasing – see section below.

1.14 Output Aliasing

REAPER also supports **Output Aliasing**. This enables you to give names to your audio outputs, names that make sense to you. This is especially useful if your sound card or other audio device provides multiple outputs. For example, one pair of outputs might be connected to your control room monitors, another to studio monitors, and a third pair to a multi-output headphone monitor. By default, your outputs will have names something like those shown here (below right). Clearly, these names are not very useful to you.

Assigning aliases to outputs can ensure that whenever you see them listed (e.g, when specifying the output to be used by your Master) your own names will be displayed, instead of the hardware device output numbers.

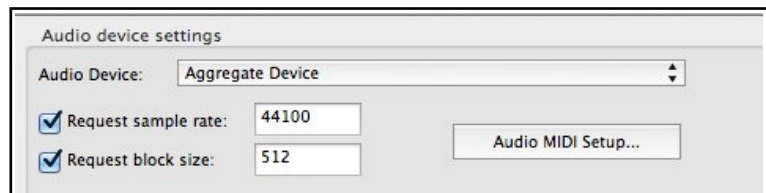
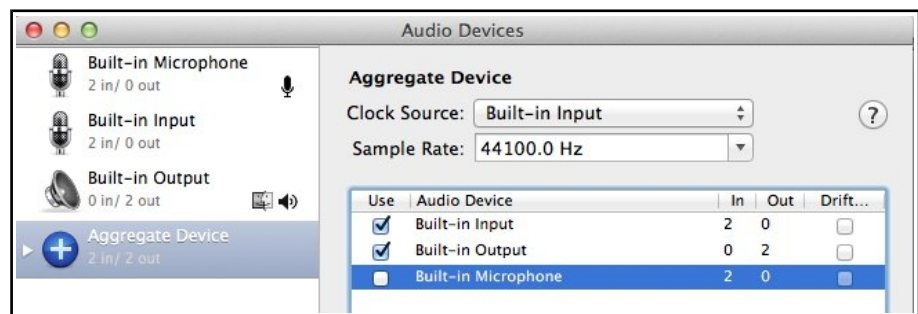
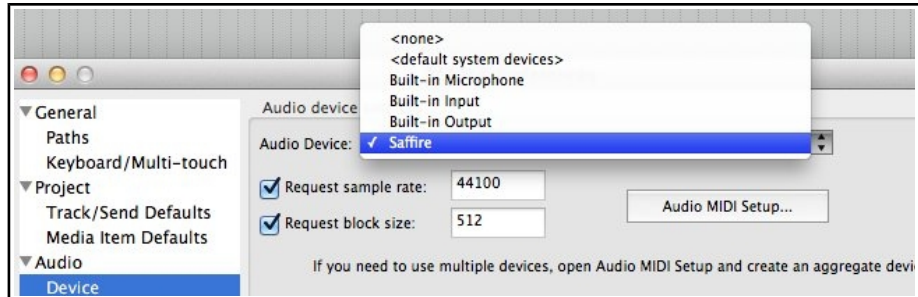

Example

To create output aliases:

1. Choose the **Options, Preferences** command.
2. Display the **Audio** page. In the section **Channel Naming/Mapping** tick the option **Output Channel Name Aliasing/Remapping**.
3. Click on the **Edit Names/Map** button.
4. Double-click in the Aliased Names column on each item in turn to edit them. In each case, after typing your preferred alias, click on **OK** to return to the **Output Channel Alias/Mapping** window.
5. Click on **OK** to close this window and return to the **Preferences** dialog box.
6. Click on **OK** to close the dialog box.

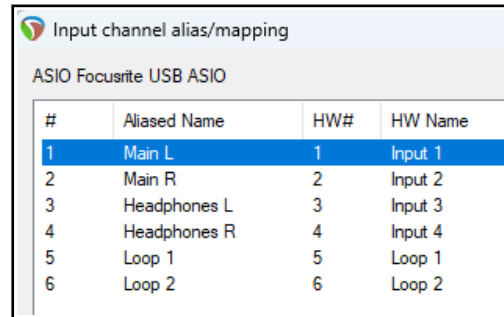

Your specified names will be automatically used throughout REAPER. The topic of assigning outputs to tracks will be covered later, beginning with [Chapter 2](#).

1.15 Setting Up For MIDI

To use MIDI, you need to enable your MIDI devices. Many PCI sound cards and USB audio devices include MIDI input and output ports (for use, for example, with a MIDI Keyboard). For beginners you should be able to simply enable the devices and accept the default settings. Other options are available for more advanced users.

MIDI Input

Choose **Options, Preferences** from the Main Menu, then display the **MIDI Inputs** screen (under **Audio**). You can select in turn each of your MIDI Input devices, right-click over its name, then choose **Enable Input**. You can double-

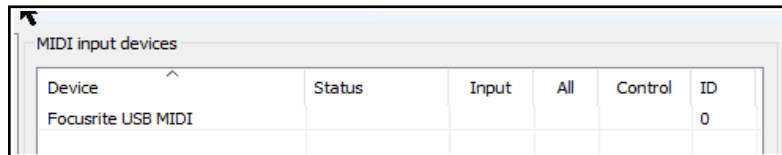

click on any input device name to display its **Configure MIDI Input** settings (see below right). This enables you to assign your own name (or alias) for the device, or to specify your advanced timestamp options (if required). You can also **Enable input for control messages** if you wish to use the device as a MIDI controller – see also [Chapter 15](#).

Where several devices are present (input or output) you can click on any column header (Device, Mode or ID) to sort the device list in that order.

If the device list includes items no longer present use the option to **Ignore device**.

To assign your own name or to specify a time offset for any MIDI Input or Output device, right click over the device name and choose **Configure Device** from the context menu. If you have a joystick that you wish to use with REAPER you should click on the **Add virtual MIDI** button, then **Add joystick MIDI**, then select the device name and processing script. You can also specify whether you wish to use it for Virtual MIDI Keyboard input an/or as a MIDI control/learn device.

To use a Control Surface, such as a Presonus Faderport, with REAPER, you should **Enable input for control** and select its channel.. The use of Control Devices will be explained later in this guide, notably in [Chapters 12 and 15](#).

Reset: Near the foot of the MIDI Input Devices preferences window there is the options for **Reset all MIDI devices**.

Loopback: This advanced topic is best ignored by beginners. The **Add virtual MIDI** button includes an option to **Add loopback MIDI device**. This allows a device to receive the MIDI of the matching output, with a delay of one audio block.

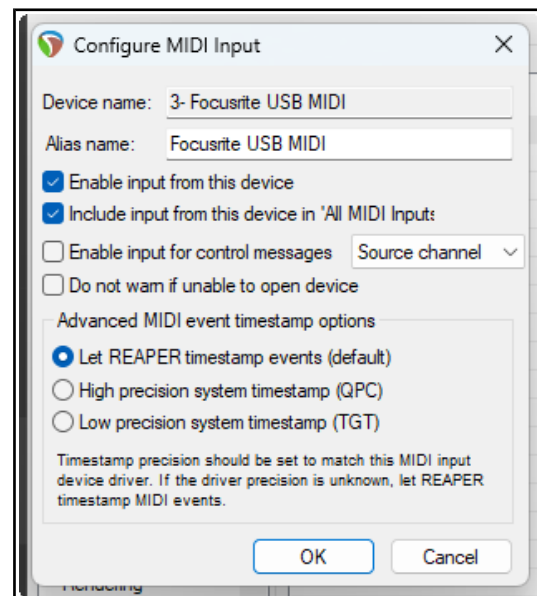

Setting Up and Getting Started

MIDI Output

Choose **Options, Preferences** from the Main Menu, then display the **MIDI Outputs** screen (under **Audio**). You can select in turn each of your MIDI Input devices, right-click over its name, then choose **Enable Output**. You can double-click on any input device name to display its **Configure MIDI Output** settings (right). This enables you to assign your own name (or alias) for the device, or to specify your advanced timestamp options (if required).

Experienced users might wish to note that these options are also available on the context menu that is displayed by right-clicking on the device (shown below).

Other Audio Preferences.

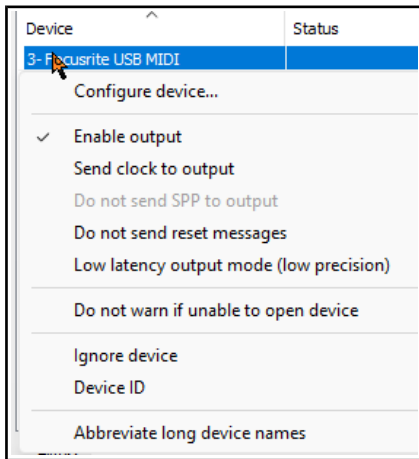

Device	Status	Enable	Clock	ID
3- Focusrite USB MIDI		•		1
Microsoft GS Wavetable Synth	[use cautiously]			0

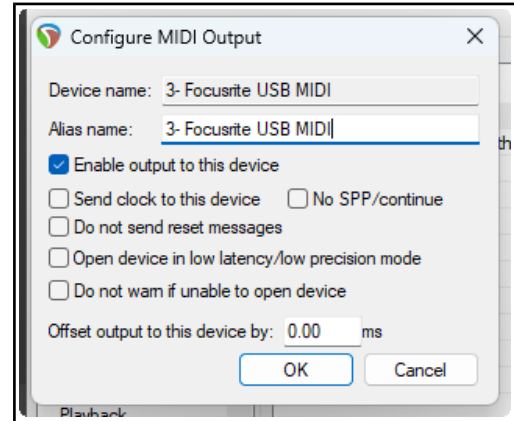

There are other Audio Preference screens that we have not yet examined, including **Buffering, Playback** and **Recording**. These

will be dealt with later in this User Guide, particularly in [Chapter 22](#). Newcomers are advised to leave these settings at their defaults: you can return to change them later if the need arises so. When finished, clicking on **OK** will, of course, close the **Preferences** box and cause your settings to be remembered.

This section has covered the general issues involved in setting up your system for working with MIDI. For project specific settings and options, see [Chapter 2](#). In particular, if you are working primarily with MIDI material you may wish to change the default project timebase setting. This too is explained in [Chapter 2](#).

1.16 VST, CLAP and LV2 Plug-ins

There's one further Preferences screen you will probably want to visit before you get started – **VST Plug-ins**. REAPER has several pages of Plug-in Preference screens, but most can (at first at least) be left to their default settings. However, if you have a collection of VST and/or VSTi Plug-ins (including VST3), REAPER needs to be told where to find them.

Note that VST3 plug-ins should be kept in directories separate from other plug-ins.

Choose **Options, Preferences**, then select **VST** in the **Plug-ins** section. You can use the **Edit path**

list...

button to locate your plug-ins. This offers you a number of options. **Add system VST paths** will detect and select those directories used by default for installing many plug-ins. You can also use the **Add path...** option to identify and add other folders. You can leave most other settings as they are (at least for now).

MacOS uses two "built in" folders for installing shared plug-ins. These are **Library/Audio/Plug-Ins** and **Users/<your account>/Library/Audio/Plug-Ins**. REAPER will scan these by default: you should, however, check that they are automatically listed as your VST plug-in paths. If not, you should add them.

By default, REAPER will scan the specified directories to look for new plug-ins each time it starts up. You can disable this by turning off the option **Scan new/updated plug-ins on startup**.

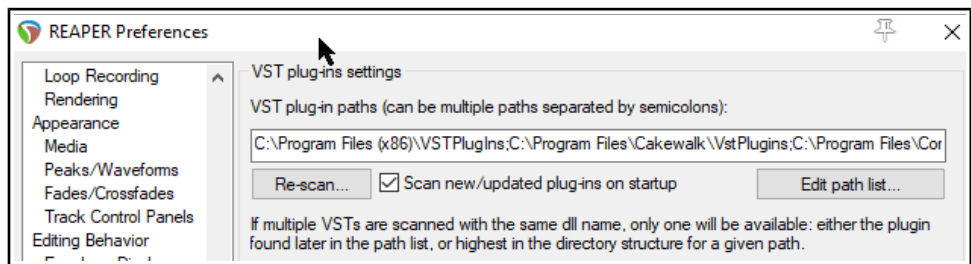

Up and Running: A REAPER User Guide v 7.31

Windows by default uses C:\Program Files\Common Files\VST3, but if your VST plug-ins are spread across several folders it might not be able to locate all of these for you. In this case you may need to use the **Add path ...** option several times, each time selecting one of your folders. Use the **OK** button in the **Browse for folder** window each time after selecting the folder name. Clicking the **Re-scan** button in the above window will then make the contents of your VST and VSTi folder(s) available immediately. REAPER will also scan any subfolders. **Re-scan...** button will also check for any listed plug-ins that failed to scan earlier.

REAPER will automatically scan your VST folders each time the program is launched. You can also return to this screen at any time and add more VST folders later. Specify the extra location(s) of your VST plug-ins, then **Re-scan** then **Apply** then **OK** to close this screen and cause your new settings to be remembered. You can find more information about the various [VST Preferences settings](#) and options in [Chapter 22](#).

VST and VST3: important note: REAPER scans for VST plug-ins according to your directory list, from left to right. If a VST3 plugin is named even slightly differently from its VST version, both will be installed. If both are named identically, only the last one found will be installed. Consider making your VST3 directory last in the list.

Of special use to Linux users, REAPER will also automatically scan for LV2 plug-ins, and install any that it finds. Various options for managing LV2 plugins are available on the [Options, Preferences, Plug-ins, LV2/CLAP](#) page.

REAPER also supports Clever Audio Plugin format (CLAP) plug-ins. Options for scanning and installing these are also available on the LV2/CLAP preferences page.

1.17 REAPER's Installed Folders and File Location

The locations to which REAPER's various resources are installed will depend on whether you are using OS X or Windows, and even then which

version: for example, Windows 11 behaves differently from 7. To identify where the various files are located, choose **Show REAPER resource path in explorer/ finder** from the **Options** menu.

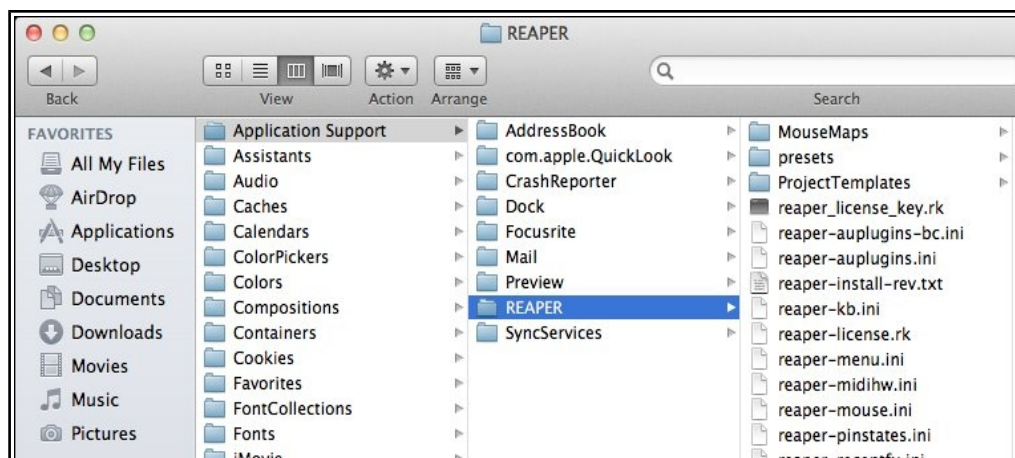

Shown here is an example of the OSX Finder path. The Windows Explorer display is similar. Several of these files will be referenced elsewhere in this guide. Meanwhile, you might find the following table helpful:

REAPER's Installed Folders and File Locations	
The Registry (Windows only)	Windows users note: REAPER does <i>not</i> store any install data, settings or preferences in your Windows Registry. Windows will set up an item for REAPER under HKEY_LOCAL_MACHINE, Software but it contains no data other than keeping a record of your file movements in Registry areas such as its MUICache and creating file associations, so that you can open .RPP files (for example, in Windows Explorer) by double-clicking on them.
The REAPER Install Directory – MacOS	MacOS installs REAPER to its Applications folder. Copy any PDF files (such as this User Guide) that you want to be able to access from REAPER's Help Menu to: /Users/<username>/Library/Application Support/REAPER With some versions (e.g. Lion) you may need to hold down the Options key while displaying the Go menu to make this path accessible.

Setting Up and Getting Started

REAPER's Installed Folders and File Locations			
The REAPER Install Directory - Windows	<p>By default, REAPER on Windows installs to C:\Program Files\REAPER. Copy into this directory any PDF files (such as this User Guide) that you want to be able to access from REAPER's Help Menu.</p> <p>Some of the optional install items are held in sub-folders of C:\Program Files\REAPER. These include the COCKOS ReaPlug VST plug-ins and (if installed) the SWS Extensions. Anything stored in this directory is accessible to all users of REAPER on this computer.</p> <p>Most REAPER features (such as configuration files and custom settings) are placed into an Applications Data or AppData folder. The location of this will depend upon which version of Windows you are using.</p>		
The Application Data/Support Directory	<p>To access the REAPER AppData or Application Support folder, choose Options, Show REAPER resource path... from REAPER's main menu. Some of the main items you can expect to find there are listed below.</p>		
Sub Directories	<p>You should find that you have a number of sub-directories here, such as:</p> <table style="width: 100%; border: none;"> <tr> <td style="width: 50%; vertical-align: top;"> <ul style="list-style-type: none"> Color Themes Configurations Cursors Data Effects FXChains KeyMaps MenuSets </td> <td style="width: 50%; vertical-align: top;"> <ul style="list-style-type: none"> Plug-ins Presets Project Bays ProjectTemplates QueuedRenders Scripts TrackTemplates User Plugins </td> </tr> </table> <p>Many of these are self-explanatory, especially those which contain the various files and items that you can create yourself as an aid to managing your REAPER projects. For example, any FX Chains that you create will be stored on the FXChains sub-directory. Custom menu and toolbar data is stored in the MenuSets sub-directory, and so on.</p> <p>Topics such as creating FX Chains and Custom Menus are covered elsewhere in this user guide.</p> <p>Information held in the Data directory includes track icons and toolbar icons. The Effects folder is where your JS effects are stored.</p>	<ul style="list-style-type: none"> Color Themes Configurations Cursors Data Effects FXChains KeyMaps MenuSets 	<ul style="list-style-type: none"> Plug-ins Presets Project Bays ProjectTemplates QueuedRenders Scripts TrackTemplates User Plugins
<ul style="list-style-type: none"> Color Themes Configurations Cursors Data Effects FXChains KeyMaps MenuSets 	<ul style="list-style-type: none"> Plug-ins Presets Project Bays ProjectTemplates QueuedRenders Scripts TrackTemplates User Plugins 		
preset-vst-plugname.ini	<p>For each VST plug-in, a separate file is used to store any presets that you have created or imported.</p>		
REAPER.ini	<p>This includes all of your Options, Preferences settings, information about your last screen layout, and your recently used projects history.</p>		
reaper-dxplug-ins.ini reaper-vstplug-ins.ini	<p>These files store information about your installed plug-ins.</p>		
reaper-reginfo.dat reaper-reginfo.ini	<p>Store your product registration data</p>		
reaper-recentfx.ini	<p>This file stores a list of your recently used FX: this list is used to produce the Recently Used FX submenu that is available in the Mixer.</p>		
screensets.ini	<p>This file stores details of your windows screen sets. Note that track screen sets are stored with the relevant .RPP file.</p>		
Specify Default Paths for Saving new projects, Recording and Rendering (see also Chapter 3 and Chapter 22).	<p>You can use the General, Paths page of your Options, Preferences to specify default paths saving new projects and for your recorded media items. For recorded media, however, any path specified in your Project Settings will take precedence over this.</p> <p>You can also specify default paths for your waveform peak files and for project rendering.</p>		

Up and Running: A REAPER User Guide v 7.31

There's one more thing that might interest you here. All of the settings, preferences and custom files are text files. Any of them can be opened and modified using a text editor such as Notepad. This even applies to REAPER's project files, with .RPP extension. Of course, most probably you will never need to do this, and if you do, you should always take a copy first, just in case of any errors or accidents. However, you should **never** try to use a text editing program to open, view or edit any file ending in **.app**, **.dmg**, **.exe** or **.dll**

1.18 Localization and Language Packs

You can select a language pack for REAPER to use for its menus, dialog boxes, tool tips, and so on. The default language is U.S. English. Language packs are managed from the **General** page of REAPER's **Preferences**.

To see what language packs are available, and to download any, click on the link **Download language packs** (see below). This will take you to a URL where you can follow the links (including to REAPER Stash) to find your language. After downloading, close the Preferences window and use the command **Options, Show REAPER resource path in Explorer/Finder** to display REAPER's resource folders. Next, drag and drop the downloaded file(s) into the LangPack folder.

To select a language pack other than U.S. English, select from the drop down list (right) and click on **OK**. You will need to restart REAPER for the language to take effect.

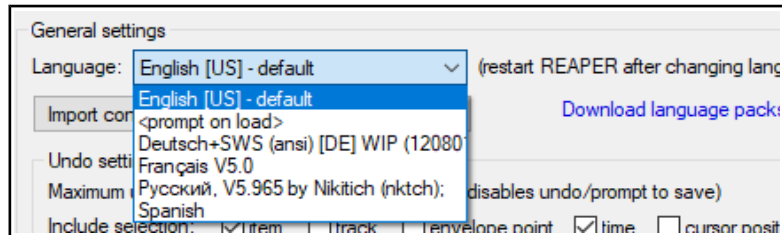

1.19 Backing Up Settings

In this chapter you have been introduced to some of REAPER's settings and preferences. As you progress, you will find many more. You can back up these settings and preferences at any time. This can be a good precaution to take against system failure, and can also be used to ensure identical REAPER installations on two or more machines. The procedure for doing this is explained in REAPER's General Settings ([Chapter 22](#)) in the categories Import Configuration and Export Configuration. Don't be concerned if you do not yet understand the meaning of many of the options. Just keep it in mind that this facility is always available.

If uncertain about what to back up, it can be a sensible precaution to backup all your configuration settings from time to time, each time to a new ReaperConfig.zip file. How often you should do this really depends on how often you make changes to any of your settings, and how important those changes are to you. Remember to keep a copy of your ReaperConfig.zip files off line, for example on an external drive or a USB flash drive.

1.20 Running REAPER on a Flash Drive

You can install REAPER on a USB flash device, or other external drive. This ensures, for example, that if you are going to be away from home or your normal workplace, you can take your USB Stick (or external drive) with you, plug it in to a computer, and away you go. Before you can install REAPER on a flash drive, it makes sense to first install it on your hard drive. When you then install REAPER to an external device in this way, all your settings, preferences etc. are also migrated.

The install method is different for MacOS and Windows users.

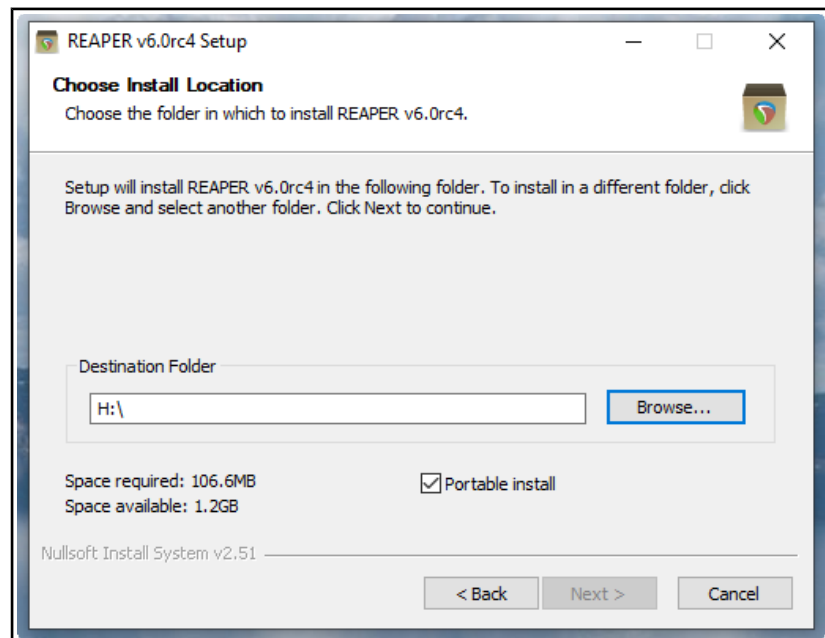

Setting Up and Getting Started

MacOS

1. Insert the flash drive into a USB port. Create a new folder on this flash drive, e.g. REAPER4. In this folder create an empty text file called reaper.ini
2. Open the Mac folder containing the REAPER disk image (.dmg) file: this will most likely be Downloads.
3. Double click on this file to open it. Drag and drop the REAPER icon to the new folder on the flash drive.
4. Be patient. There is a large number of files to be transferred. This can take 10 minutes or more.

Windows

1. Insert your external device into an available USB port on your PC. Note its drive letter (e.g. E:, F:, G:, H:, I:. etc.). This will depend how many internal hard drives, disk partitions, external hard drives, DVD burners, etc. you have already installed.
2. Double click on the REAPER install file to start the install process.
3. Click on **I Agree** to accept the license agreement. The Choose Install Location window will be displayed.
4. Enable the option for **Portable install**.
5. Click on **Browse**. Select your flash drive and click on **Make New Folder**. Name the folder (e.g. REAPER) and press **Enter**.
6. On returning to the screen shown here, work your way thru the installation process in the normal way.
7. Wait while the various files are installed. There are a lot of files and this might take quite a few minutes.

1.21 REAPER Start Menu Options (Windows only)

Normally to start REAPER you can simply double-click on your Windows desktop shortcut. This will cause REAPER to be started in accordance with your existing preferences and settings. However, for times when you do not wish to do this, you should also be aware of other options available from the Windows **Start** menu.

Click on the **Start** button, then **All Programs** then **REAPER** (or **REAPER x64**, as appropriate) to be presented with a flyout menu of choices:

Menu Command	Explanation
Install REAPER to USB key	This can be used to install REAPER to a Flash drive or similar device. However, the method described earlier in this Chapter is simpler!
REAPER	Starts REAPER normally, with last project.
REAPER (create new project)	Starts REAPER with a new project file.
REAPER (reset configuration to factory defaults)	Starts REAPER and resets all settings, options and preferences to factory defaults. Use this with caution!
REAPER (ReWire client mode)	Opens REAPER as a ReWire client. This is beyond the scope of this User Guide, but is discussed in overview towards the end of Chapter 17 .
REAPER (show audio configuration on startup)	Starts REAPER with the Audio settings Preferences page.
REAPER EULA	Displays License information.
Uninstall REAPER	Uninstalls REAPER. If you need to uninstall REAPER for any reason, you should always use this method.
Whatsnew.txt	Opens the text file displaying a history of new features and changes introduced in each version of REAPER.

1.22 REAPER File Types

Like any other program, REAPER creates a series of files that it uses to store your work. Some of the main file types and their purposes are described in the table below, along with other useful information.

File Type	Example	Explanation
.RPP REAPER Project File	Alone.RPP	This file is the core of your project. It holds all the information about your tracks, your media and their settings. .RPP files are stored in text format.
.RPP-bak Project Backup File	Alone.RPP-bak	When you save an existing project file, the previous version is saved with the .RPP-bak extension. You can recover a project from its previous state by opening the backup file.
Note: Sooner or later you should familiarise yourself with REAPER's project backup options (see section 22.3.1 of this guide) for managing and organising your backup files.		
.RPP-UNDO Undo History File	Alone.RPP-UNDO	This file type will be created if the option to save undo history with your project files is enabled in the Undo Settings section of the General section in your Options, Preferences window. See Chapter 2 for more information.
.reapeaks REAPER Peaks File	Vox.wav.reapeaks	These files contain the information necessary to enable REAPER to draw the waveforms etc. on your media items.
.reapindex REAPER Peaks File	Vox.wav.reapindex	These files contain index information about your individual media items.

1.23 User License Information

By default, REAPER's title bar will display license information such as the registered user's name. This can be changed on the **Purchase** tab of the window that is opened by the **Help, About REAPER** command.

Alternately, you can set your display to full screen mode – this is toggled on and off in Windows by pressing **F11**, in OS/X by **Cmd F11**.

1.24 Pops and Clicks

You're nearly ready to start making music with REAPER! Before you do, though, you should take a few moments to read this section, which deals with the not uncommon problem of unwanted pops and clicks being heard when you play back your music. This is a computer issue rather than a REAPER specific issue, and is generally less likely to occur with a Mac than with a PC.

If you encounter unwanted pops and clicks when you play back a song in REAPER, then most probably all it means is that your audio device settings are not right for your computer. As a quick fix, try adjusting the block size (**Preferences, Audio, Device**), starting at 128 and working up thru, 256, 512, 768 or 1024 to find the lowest setting for your system at which you can play back your music without any pops or clicks getting in the way. If you do encounter this problem, you should also read [Chapter 22](#) to learn more about this topic.

1.25 Uninstalling REAPER

There is no need to uninstall your current version of REAPER before installing a new one. Your existing installation will automatically be upgraded from the new installation. However, should you wish to uninstall REAPER for any reason, MacOS users should simply drag the REAPER icon into Trash and then remove the folder **~/Library/Application Support/REAPER**. Windows users should follow this procedure:

1. Click on the Windows **Start** button, then **All Programs**, then **REAPER** then **Uninstall REAPER**.
2. When the REAPER Uninstall Wizard is displayed, click on **Uninstall**.
3. When the uninstall process is finished, click on **Close**.
4. When prompted, choose **Yes** if you wish to see which files have been left on your Hard Drive, otherwise choose **No**.

Tip: If you are likely to be reinstalling REAPER at some later date, do not remove these files. This will ensure that your previous settings and preferences will be recalled when it is reinstalled.

REAPER Project Basics

2 REAPER Project Basics

In this chapter you will be shown the basic essentials of working with a project file in REAPER. Topics include opening and closing files, navigating the REAPER environment, working with tracks and audio effects, and more.

Track Panel and Mixer Panel Layouts. By default, REAPER uses **Layout A** for both panels. With this layout, when the mixer is open, some track panel controls are not visible: when it is closed, all track controls are visible

2.1 Opening an Existing Project

To open an existing REAPER Project File, use the **File, Open Project** command, or the keyboard shortcut **Ctrl O**. As with other Windows Apps, you will need to navigate to the appropriate folder to find your project. Recently used projects can more easily be opened using the **File, Recent Projects** command. This causes a list of up to the last 100 recently used project files to be displayed. You can then select any file from that list.

The **General** page of your **Options, Preferences** window offers a number of options. At this stage there should be no need for you to dig deeply into these, but be aware that they are there. In particular, you can:

- Select a **language** other than English, provided that the necessary language pack is installed.
- Manage your **Export** and **Import** configurations. These let you transfer copies of your various REAPER preferences and settings between computers.
- **Startup** settings determine

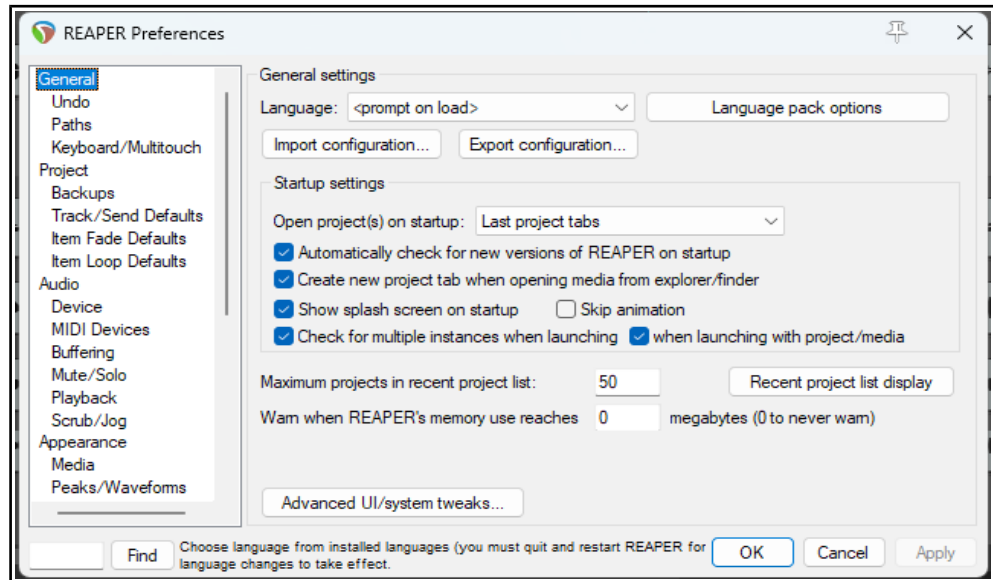

- **Startup** settings determine REAPER's behavior each time you open the program. You can choose to open the **Last project tabs**, i.e. any projects that were open when REAPER was last closed, or to open a **New project** or to **Prompt** you every time.
- Specify whether you want to **Automatically Check for New Versions of REAPER on Startup**.
- Whether to **Create a new project tab** for projects opened from explorer/finder. This option will leave any project (s) already open to remain open on separate tabs.
- Whether to **Show splash screen on startup** and if so, whether to **Skip the animation**.
- Whether to **Check for multiple instances of REAPER on startup**. If enabled this will prevent you from opening another instance of REAPER when one is already open.
- Determine the number of files displayed on the **Recent project list** and what information to display (e.g. file name only, file name and path, with an option also to **Clear recent project list**).
- Whether to warn you when **REAPER's memory usage** reaches a specified level.

Notice too the command **Continuous scrolling** on REAPER's main **Options** menu. If disabled (the default), the play cursor will scroll from left to right during playback. If enabled, this cursor will find and then remain stationary in the center of the arrange window during playback, while the media items scroll across the screen.

The examples used throughout this guide use the project file **All Through The Night.RPP**. This can be downloaded from www.cockos.com/wiki/index.php/REAPER_User_Guide. It might help you to keep that project open while using this documentation. Take a copy of these files and work with them.

2.2 Project Settings

REAPER project settings can be set for individual projects. The **Project Settings** dialog box is opened by the **File, Project Settings** command, or by pressing **Alt Enter**. The five pages of settings are- **Project Settings, Media, Video, Advanced** and **Notes**. If in doubt, accept the default values.

Project Settings: Project Settings

- **Project Sample Rate:** for example, 44100 Hz (CD standard) or 48000 Hz (DVD standard).
- Option to force the time signature to beats or whole samples.
- Project **beats per minute, time signature** and **beat basis**.
- Method for setting the **timebase** for items/envelopes markers and for tempo/time sig - essentially you have a choice of Time, Beats (position, length rate) or Beats (position only).
- **Project start time and measure** (includes option to **Base ruler spacing on measure 1**) Leave these at their defaults for now. In [Chapter 12](#) you'll see when, why and how to change them.
- There is an option to **Base ruler markings** off any specified start measure. The default is the first.
- Playback and render **resample mode** – from Lowest (point sampling) thru Medium (64 Sinc) to Extreme HQ (768 HQ Sinc).
- **Default modes and parameter to be used for pitch shifting and stretch markers** See [Chapter 10](#).

Project Settings: Media

These include:

- **Paths** (primary and secondary) to store media files. For example, if you specify "Audio" then your media will be stored in a folder called Audio, as a sub-folder of the project folder. If left blank, REAPER will use the project file folder.
- Option to **use or over-ride the global preference for copy media on import**. Media items can be copied to the project file folder.
- **Recording format** - typically WAV or MP3, but there are others, e.g. AIFF, DDP, FLAC, OGG Vorbis Video (GIF) and WavPack. Each of these comes with its own set of options and settings.
- **Settings** and specifications for chosen recording format – e.g. for WAV files this includes Bit Depth.
- Whether to include **markers** and/or **regions** and whether to **embed the project tempo**.
- Preferred **media formats** when FX are applied, or items are glued or frozen, and when media items are **rendered**. Also, default media format for **project** and **regions**. You have the same range of formats, options and settings as you have for recording format.

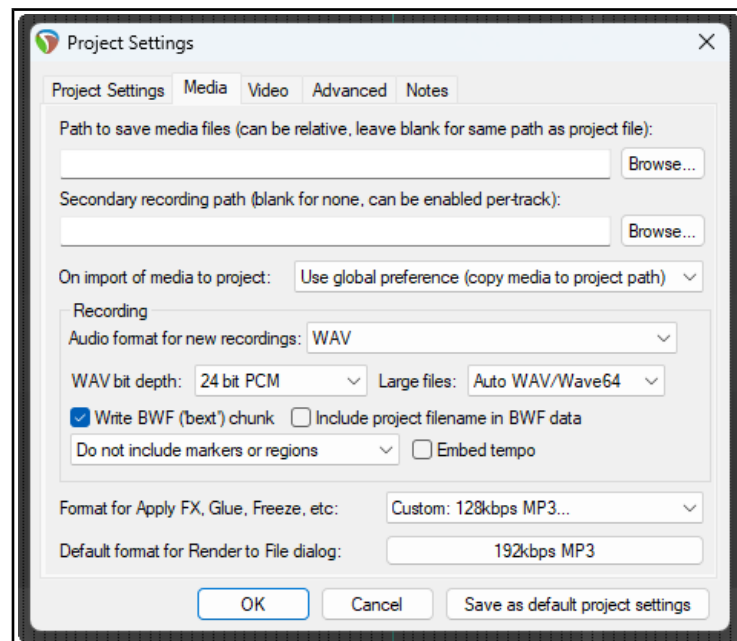
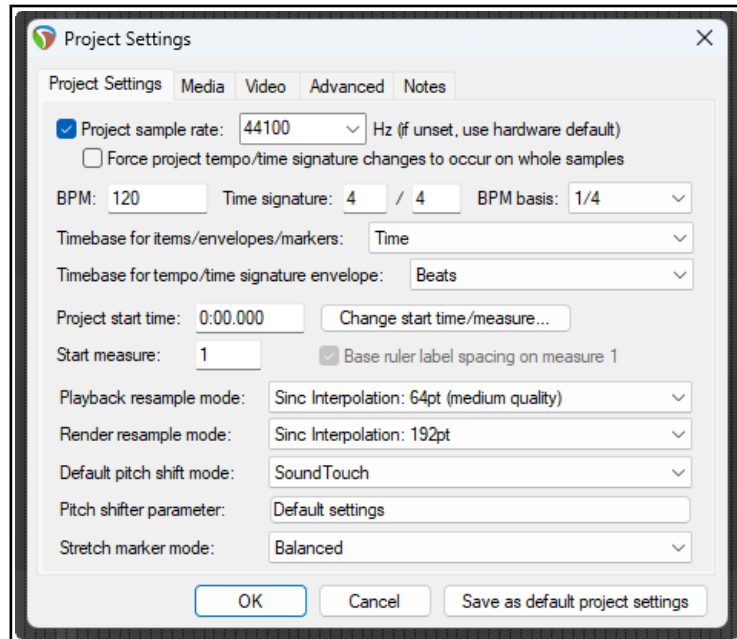

REAPER Project Basics

Project Settings: Advanced

- **Item Mix Behavior.** See right. Determines behavior when one media item is placed on top of another: enclosed items to replace enclosing items, items always to be mixed, or for the newer item to replace older item.
- **Track mixing depth.** If unsure, leave at the default setting.
- The option to allow **feedback in routing.** Feedback routing can risk damage to audio equipment. *If in doubt, do not select this option.*
- **Auto-bypass FX that report tail length or have autotail set ...**
- **... threshold.** Establishes dB floor below which a FX [where this option has been enabled](#) should be bypassed.
- The option to **synchronize** project with an external device timecode.
- **Rewire client settings.** These are shown below right.
- There are options to limit **project length** and **recording time**, also to set the default state for **Preserve pitch when changing rate.**
- Option to **prevent bezier envelope segments being affected by surrounding non-bezier points.**
- **Smooth abrupt volume/pan/width envelope changes:** applies square envelope points less abruptly.
- Default number of **track channels** and **parent send channels** for new projects (up to 128).
- Specifying a track **default pan law** . The [pan law](#) determines how relative track volume behaves when a track is panned more to one side or the other.
- **Gain compensation boost** can be enabled or disabled. This is discussed in more depth [later in Chapter 2](#).
- **Default track pan mode.** You have choice of [pan modes](#), some mono, some stereo. [See Chapter 11](#).

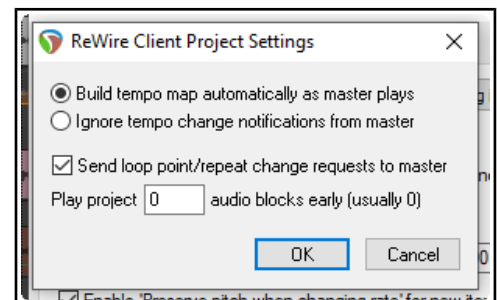
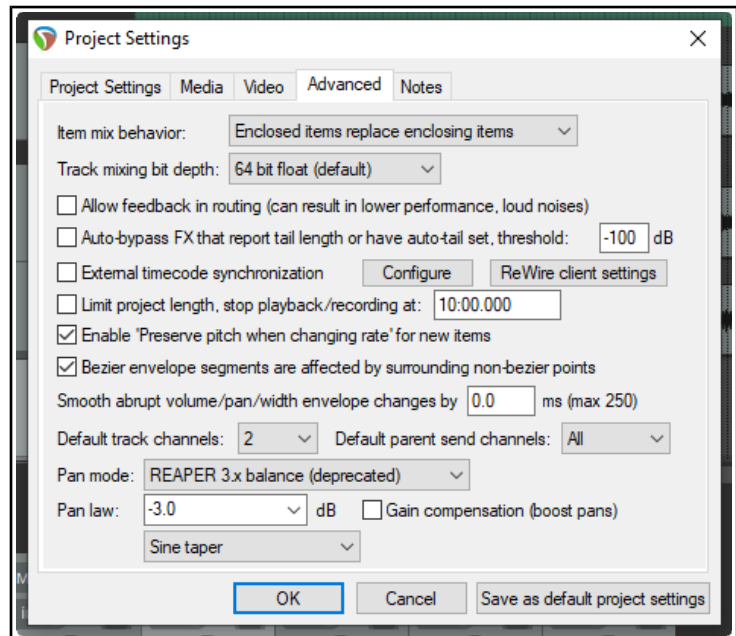
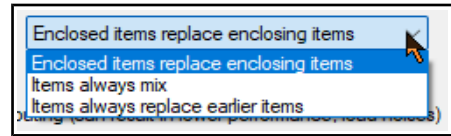

Project Settings: Video: Explained in [Chapter 20](#).

The Project Timebase Settings

The project timebase controls how media items, envelopes and project markers behave when project tempo changes. If possible, get your project timebase settings right *before* you record or import any items. The default is **Beats (position, length, rate)** for items/envelopes/markers and **Beats** for tempo/time sig envelopes. For more information choose the main menu command **Help** then **Project timebase help**.

It's worth also noting that you can still over-ride the project timebase setting for individual tracks within your project. To do this, select the track(s) and choose **Track timebase** from the track control panel context menu. To do this for an individual item, select the item then press **F2** to display the Item Properties dialog box.

Project Settings: Notes

Notes and comments can be included with your project file. Options include automatic word wrap and automatic display of notes each time the project is opened. By default, word wrap is turned on for new projects. Text saved as the **Title** or **Author** can be used with the \$title or \$author wildcards as [metadata](#) when rendering.

Save as default project settings: click this button if you wish to save all your project settings as defaults for new projects: options can be changed for individual projects.

2.3 The Transport Bar

If the Transport Bar is not visible in your REAPER window, use the **View, Transport** command to display it, or use the keyboard shortcut **Ctrl Alt T**. The Transport Bar appears docked just below arrange view, or, as shown here, as a floating window (undocked) inside REAPER. The main Transport Controls are shown here, though your exact layout might not be identical.

The four standard transport buttons are **Go to Start, Go to End, Record and Play**. After these come **Toggle Repeat loop, Stop and Pause**. The **Stop** button stops playback and returns the play cursor to the position it was in when playback started. The **Pause** button pauses playback without moving the play cursor.

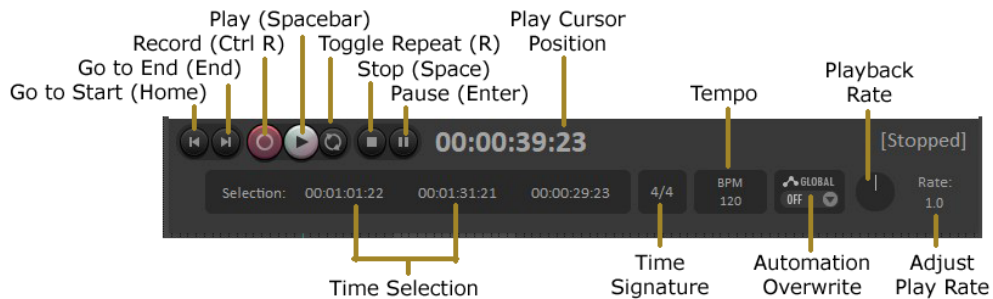

If the material being played is too long for all of it to be displayed at once then the display will scroll as necessary, provided that **Options, Automatically display view during playback** is enabled.

The **Record** button starts and stops recording, without stopping playback. Clicking on the **Stop** button when recording will stop both playback and recording. The **Toggle Repeat** button turns on and off the option for any looped time selection to be played over and over again during playback.

The **Global Automation Override** feature will be explained in [Chapter 18](#). Further to the left of this the current **time selection** is shown (start position, end position and length).

The current **play cursor position** is also shown: in the above example this is 7.1.00/0:12.000. Above this and in the center is the **playback status** (Playing, Paused or Stopped). Notice also edit boxes that show the project **Tempo (BPM)** and **Time Signature** values. To change the value of either box click in the box and type the new value. Depending on your mouse preferences ([Chapter 22](#)), you can also use your mousewheel to adjust this. The beat basis (quarter note, eighth note, etc) is displayed above the tempo, and can be changed at the current cursor position from the menu that is displayed by right clicking in this area.

Finally (in the above layout) is the **playback rate**. This can be made faster or slower by adjusting the fader knob. If adjusted, this knob is colored green. Double-clicking resets the rate to 1.0. You can also hover your mouse over the box and use your mousewheel to increase (up) or decrease (down) the value.

Three other useful transport control keys are **Ctrl Left** (go back a little), **Ctrl Right** (go forward a little) and **Alt Space** (play, skipping loop selection).

Right clicking over the Transport Bar displays a context menu. This may seem slightly intimidating at first. We'll get to the more advanced stuff in [Chapter 10](#), but for now just notice that there are menu options available to:

- Select your preferred time display format.
- Dock or Undock the transport in the Main Window. You can choose the main docker or any of four other positions – **Below arrange view, Above ruler, Bottom of main window or Top of main window**.
- Flash transport status as yellow if a possible audio under-run is detected.

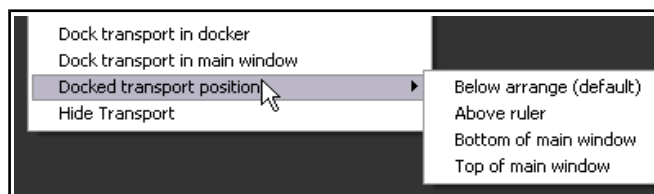

Note: The transport bar appearance can be modified using the **theme adjuster**, for example to hide any controls surplus to your requirements. See [Chapter 15](#).

Scrubbing

The top of the edit cursor is marked by an upside down triangle. You can grab this with your mouse and drag to move the edit cursor without affecting playback. Depending on your preferences settings, you may need to hold down the **Shift** key. If you do this when the project is not playing, it will "scrub" your audio -see [Chapter 10](#) of this User Guide.

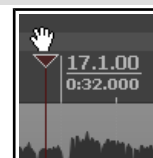

REAPER Project Basics

2.4 Using the Track Controls

Basics

First, make sure that you are using REAPER's default theme – to do this choose **Options, Themes, Default**. As things stand, when you play back a project the same sound comes out equally from both speakers. That's because no adjustments have been made to any track's Volume or Pan controls.

Which faders are visible in the track panel is determined by your chosen track layout: in these examples, the default **Layout A** has been used: with the mixer closed, all controls are visible.

If, despite this, some controls are still not visible, you might need to enlarge your track panel. Hover the mouse over the panel's right edge and left drag out to the right.

Clicking on a track's **Route** button reveals that by default all output goes to the Master via parent channels 1/2. If this is not so, adjust the track settings accordingly and check that your [audio device output settings](#) are correct.

The first rotary fader shown here adjusts a track's **volume**. With some layouts, this is shown as a horizontal fader. The other rotary adjusts the **panning**, sending the signal more to the left or the right as preferred. If you see a second pan control, ignore it for now. This is used with some [pan modes](#) to control stereo width, a more advanced concept covered in [Chapter 11](#). To

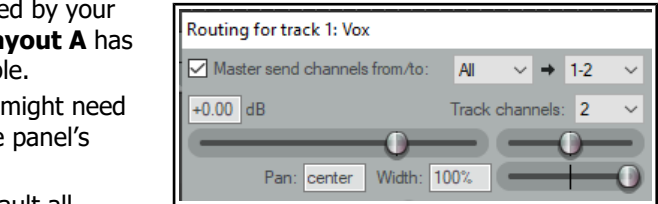

adjust any horizontal, vertical or rotary faders in REAPER, you can:

- Left click-drag faders in the direction required, releasing the mouse when finished. For rotary faders, drag up to rotate clockwise, down for anti-clockwise. Hold **Ctrl** while doing this for more subtle adjustments.
- Hover your mouse over the fader, use the Scroll Wheel to adjust the level down/up. To enable this feature, go to **Options, Preferences, Editing Behavior, Mouse** and deselect **Ignore mousewheel on track panel faders** and **on all faders**. See also [mouse behavior preferences](#) in Chapter 22.



Metering

By default, a track's VU meter shows the signal after being adjusted by the volume fader. If you wish instead to show the pre-fader level, choose from the **Options** menu **Pre-fader track metering**. There is an option in [Preferences, Appearance, Track Meters](#) for all track meters to display pre fader levels.

Routing

Clicking on the **Route** control opens the routing dialog box (shown top right of page). You can enter values as dB for volume (e.g. -6) and as percentages for pan (e.g., 25R for 25% right) and width directly into this box.

By default, volume and pan controls apply to a track's **audio** output. If you want to use these to control its **MIDI** signal, right-click on the track number in the TCP, then choose **MIDI track controls**, then **Link track volume pan to all MIDI channels** from the context menu.

Tip: To audition possible changes, hold down the **Alt** key while dragging the fader with the mouse. When you release the mouse, it will then return to its original position.

Tip: To work with more than one track, hold down **Ctrl** while clicking in the Track control panel on each track number required. Then release **Ctrl**. Any fader or other movement will be applied to all selected tracks.

Mute/Solo

The two buttons on the right of each track's control panel have these functions:

Mute	Toggles Mute on/off for selected track(s)	Note: Both the Mute and Solo controls can also be used with modifier keys such as Alt and Ctrl for various functions. See Chapter 5 for details.
Solo	Toggles Solo on/off selected track(s)	

By default, **Solo** causes the output of both the track and any sends to be heard. This is known as **Solo in place**. Thus, a soloed in place track with a send to a reverb track will play with the reverb. To hear only the track without its sends, hold the **Alt** key while soloing the track. The **phase control** button can be used to reverse track polarity.

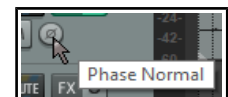

2.5 Pan Law and Pan Mode

When two channels are mixed the result is louder if both are panned dead center than if they are each panned to the extreme left and right. Pan laws enable you to compensate for this. You can choose a default pan law for new tracks in your advanced [project settings](#).

Right-click on the pan control to choose a **pan mode** (see right).

Pan modes are explained more fully in Chapter 11 when we look at [stereo panning](#). In brief, however, you have a number of options –

Stereo balance/mono pan is the default (see Project Settings). This is equivalent to the mode used in versions before REAPER 4.

You can change the **pan law** for individual tracks. Right-clicking over a track's pan fader opens a window with an option to **Override default track pan law**. Selecting from the list (in a range 0.0 dB to -6.0 dB) or type in your own value. A negative setting causes the signal at the center to be attenuated as panning increases.

The **Gain compensation (boost pans)** option if enabled causes the signal's audio strength to be boosted as it is panned further away from the center. The -3 dB and -6 dB settings correspond exactly to equal power and equal gain respectively.

The pan law dropdown options are sine taper, linear taper and hybrid taper. The default is hybrid taper. With linear taper the overall sound increases as you pan towards the center. Non-linear tapers seek to compensate for this. There is more information about pan laws here: <https://samplecraze.com/tutorials/the-pan-law/>

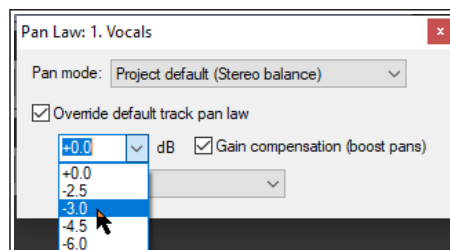
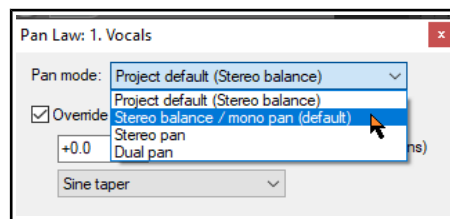

2.6 Navigation and Zooming

Mac users: remember you should substitute **Cmd** for **Ctrl** and **Opt** for **Alt** when using booster keys.

Navigating within the Track Control Panel (TCP)

The following keyboard shortcuts can be used to navigate within the Track Control Panel:

Function	Keystroke	Function	Keystroke
Go to next track.	Ctrl Alt Down	Go to previous track.	Ctrl Alt Up

Adjusting Panel Width with Mouse

To adjust the width of the track panel area, hover your mouse over the vertical border separating the TCP from the main area. The cursor changes to a horizontal double headed arrow. Drag the border left or right to decrease/increase track panel width and release the button when the desired track control panel width is reached. Double-clicking on this vertical border will toggle track panel visibility on and off.

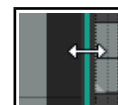

Adjusting Track Height with Mouse

Function	Action
Adjust height of single track	Click/drag up/down on lower track boundary
Adjust height of selected tracks	Alt + click/drag up/down on lower track boundary
Adjust height of all tracks.	Ctrl + click/drag up/down on any lower track boundary
Adjust height of all tracks.	Click/drag up/down between + and – on vertical scrollbar

Toggling Track Height with Keyboard or Mouse

Function	Keystroke
Minimise height of all tracks: if already minimised, restore to most recent previous height.	` (this is the key immediately to the left of 1 , usually directly above the Tab key).
Maximise height of all tracks: if already maximised, restore to previous height.	~ (on most keyboards, this is the Shift key in combination with the ` key).
Increase height of selected tracks, minimise others. Repeat to restore previous track height.	! (on most keyboards, this is the Shift key in combination with the 1 key).
Minimise all tracks.	@ (on most keyboards, Shift with the 2 key).

For a bound hard copy of the latest version of this User Guide (printed in B&W) go to LULU.com

REAPER Project Basics

Function	Keystroke
Increase/decrease height of all tracks	Ctrl click on +/- at foot of vertical scrollbar.
Toggle height of all tracks between minimised, normal and maximised.	Double click mouse on vertical scroll bar.
Make selected track(s) unaffected by track height adjustment and vertical zoom shortcut keys.	Use Lock track height command on track right-click context menu.
Lock/unlock track controls (volume, pan, etc.) including the FX chain.	Use Lock track controls command on track right-click context menu.

Zooming In and Out from the Main Menu or with Keyboard Shortcuts

Several zoom actions are available on the **View, Zoom** menu. Keyboard shortcuts are available as follows:

Function	Keystroke
Zoom in/out (horizontally)	+ (plus) or up arrow/ - (minus) or down arrow
Zoom to time selection	Ctrl Num Pad +
Zoom to selected media item(s)	(No default shortcut)
All tracks to same height and size up	Page Up
All tracks to same height and size down	Page Down
Toggle track heights to minimum	`
Toggle track heights to maximum	~
Expand selected track, minimize others	!
Minimize all tracks	@

Scrolling with the Keyboard

The following keyboard shortcuts can be used for scrolling within a project:

Function	Keystrokes	Function	Keystrokes
Scroll View down	Alt Down	Scroll View left	Alt Left
Scroll View up	Alt Up	Scroll View right	Alt Right

Zooming and Scrolling with the Mousewheel

The mousewheel can also be used for zooming in and out when you are navigating a project file. The table below summarises how the mouse wheel behaves.

Behavior	Modifier Key for Mousewheel	
Horizontal Zoom	(no modifier)	Zoom management options, such as set zoom center and max zoom level, are set in your Preferences, Appearance, Zoom/Scroll/Offset (Chapter 22). Also, the Actions List includes several zoom actions, for example to set vertical zoom according to theme defined sizes.
Vertical Zoom	Ctrl	
Horizontal Scroll	Alt	
Vertical Scroll	Ctrl Alt	

You can change any default keyboard and mousewheel assignments. For example, you could use just the Down and Up arrows (without Ctrl Alt) to go to the next or previous track, or the mousewheel without a modifier to scroll rather than zoom. [Mouse modifiers](#) are covered in Chapter 15.

Tip: Making and using a zoom/navigate toolbar. Zooming and navigating are much used activities. You can make your own Zoom/Navigate custom toolbar. Creating [custom toolbars](#) is explained in Chapter 15. Keyboard Shortcut and Mouse Defaults

The command **Help, Keybindings and Mouse Modifiers (Shift+F1)** will open your web browser with a list of REAPER's mouse modifiers and keyboard shortcuts. As you will see in Chapter 15, you can also [define your own mouse modifiers, keyboard shortcuts and action keys](#), so as better to suit your own workflow.

Tip: REAPER makes extensive use of context menus, which also show keyboard shortcuts. These are accessed by clicking the right mouse button. For example, for commands relevant to the track panel, right click over the track panel. For a media item. Right click over that item ... and so on.

2.7 The Visual Track Spacer



REAPER's visual track spacer can be used to insert a spacer between any tracks, as required. This can be helpful in easily identifying in a project tracks which belong together, or simply to prevent screen clutter. A simple example is shown here.

Shown left are a vocal track and two guitar tracks. A spacer has been inserted above the first and after the second guitar track to visually separate them from the other tracks.

Default track spacer height is 16 pixels: you can change this value in your **Options, Preferences, Appearance** settings.

Spacing is added in arrange view by right clicking over a track's track panel and choosing **Virtual spacer** from the context menu. Options are to add a spacer before or after the track, or both, or to remove existing spacers.

To add a spacer after or before a number of adjacent tracks, simply select all of the required tracks and right click over any one of their track panels: choose **Virtual spacer** from the menu, then make your selection as before.

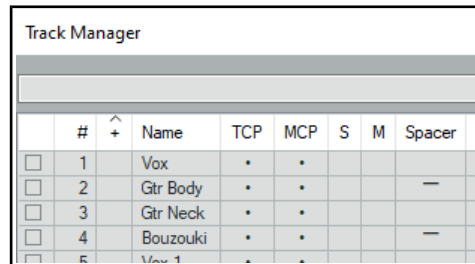
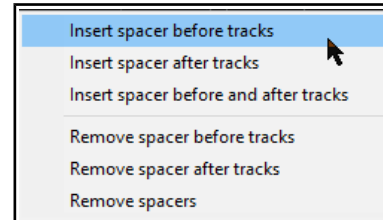

Note that if multiple tracks are selected, the space will be added before the first track in the selection, or after the last track, or both, depending on your menu selection.

A quick and easy way of adding or removing spacers between tracks is within the **track manager**. The track manager is covered in detail in Chapter 12.

For now, note that spacers can be added above any track or tracks. Simply click in the Spacer column for each track where you require

spacing to be added: click again to remove the spacer (see above left).

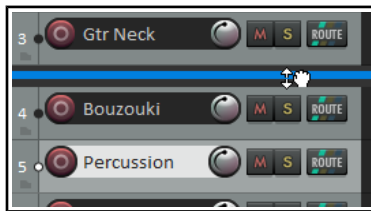

If you are moving a track or track selection up or down the track order, you can drop the track below a spacer to place it after the spacer, above a spacer to place it before the spacer, or in the middle of a spacer (as shown here) to show spacers both above and below it.

To **move** a spacer from one track to another, use **Left drag** up or down. To **copy** a spacer from one track to another, use **Ctrl left drag** up or down.

2.8 Directing Audio and MIDI Output

Audio output will by default go from your master to the first available pair of outputs on your soundcard (usually outputs 1 and 2), and only to this pair. If your sound card has multiple pairs of outputs and you wish to change this, you can do so via the **Routing Matrix (View, Routing Matrix or Alt R)**.

MIDI Output can be directed to an external hardware or virtual synth (such as Microsoft GS Wavetable) or to a VSTi Instrument plug-in. For the former. Open the track's **routing window** and select the required synth from the MIDI Hardware Output drop down list. Alternately, to use an instrument plug-in, insert the required VSTi in the track's **FX chain**. This will usually be the first item in the chain.

2.9 Using the Navigator

The REAPER Navigator shows an overview of your project. It can be zoomed in or out to display a selected area area of your project.

To display the Navigator, choose the **View, Navigator** command. Use **Ctrl Alt V** to toggle the Navigator display on and off.

You can also use the Navigator to scroll thru your project. Simply position the mouse over the box within the navigator window that represents the on-screen area of your project. Then hold down the left mouse

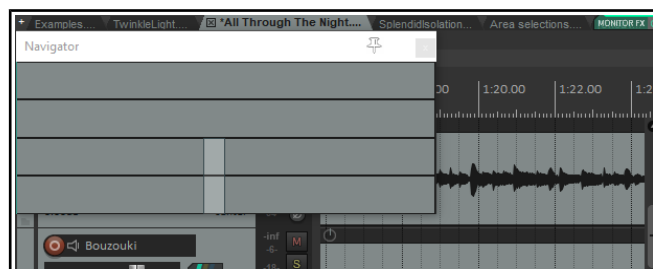

REAPER Project Basics

button, and click and drag to scroll the display. Release the mouse button when finished. Other ways of using the **Navigator** are:

Activity	Method	Activity	Method
Define area to display	Right drag	Zoom in/out tracks only	Alt right drag
Reposition display area.	Left click	Zoom in/out time only	Ctrl right drag
Move display area.	Left drag	Move play area and cursor	Ctrl left click

Note also that the mousewheel can be use to scroll and/or zoom as in workspace itself.

2.10 Track FX Basics

FX can be used with REAPER, for purposes such as EQ, compression, chorus, reverb and more. Track FX (JS, VST, VST3 and DX, VSTi , VST3i and DXi, and, for Mac users, AU) can be added to tracks and media items from the FX browser or by directly inserting them into the track or item FX Chain. Media item FX are explained in [Chapter 6](#).

Many FX plug-ins are supplied with REAPER, including Jesusonic and Cockos effects.

We'll examine many of these later in this User Guide, especially in [Chapters 6](#) and [16](#). For now, let's just focus on some general aspects of how audio FX fit in to the REAPER scheme of things. To access any of these FX, simply follow these procedures:

FX can be added to any track or item FX directly from the main FX Browser window. Each track and item also has its own FX window: these are most suitable for managing the individual FX parameters and the FX chain itself, although FX can also be added to individual track and item FX from within this window.

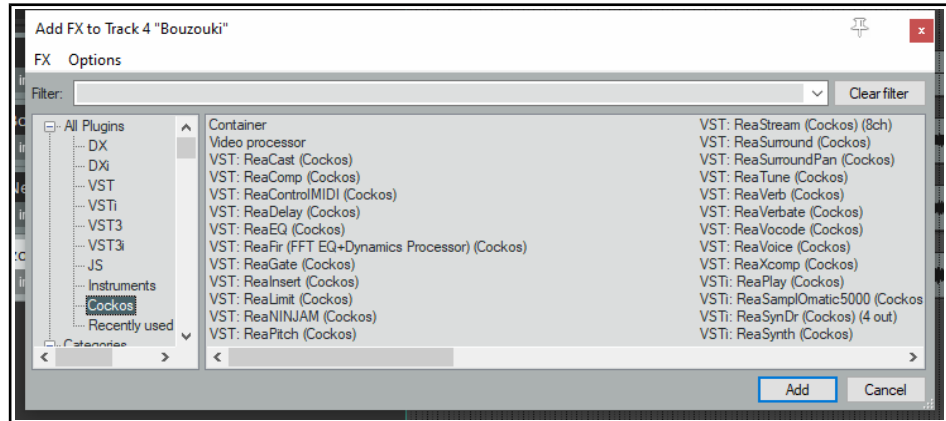

From the FX browser...	You can do this ...
Open the FX Browser	Choose View, FX Browser command or press Shift F .
Add FX to a track or item	Drag and drop FX from FX Browser to track panel or mixer panel or item.
Add FX with preset	Right click on FX name, choose Add with preset from menu.
Add several FX to a track or item	Use Ctrl left click to build selection. Drag and drop selection from FX Browser window to track panel or mixer panel or item.
Add one or more FX to a number of tracks or items	Select the tracks (track panel) or items (arrange view). Select the FX. Right click over any selected FX, choose Add to selected tracks or Add to active takes of selected items .
Rename the FX	Right click on FX name, choose Rename FX... from menu.
Create keyboard shortcut	Right click on FX name, choose Create shortcut ... from menu. This shortcut can now be used to insert that FX into any track or media item.
Set default preset for FX	Right-click on FX name, choose Set default preset and select a preset from the list.
Insert previously saved FX chain in a track or item.	In FX Browser, select Chains in left hand panel. Drag and drop required chain to track panel or mixer panel or item.

From the FX browser...	You can do this ...
Create new track and add FX	Drag FX from FX browser window to empty area of track panel.
Dock FX Browser	Right click on title bar, choose Dock FX browser in docker To undock, right-click on browser tab and deselect Dock FX browser in docker .
Advanced technical default options	More advanced technical options are documented in the section Advanced plug-in defaults .
From a track FX window...	You can do this ...
Open a track's FX window	Click on track's FX button. If no FX chain already exists for this track, click on Add button.
Add FX to track FX chain	Double-click on the required FX in FX browser window.
Add several FX	Use Ctrl click to build selection, then click on FX browser Add button.
Set FX to bypass (toggle)	In the FX chain, click on the FX name, press Ctrl B .
Set FX to offline (toggle)	In the FX chain, click on the FX name, press Ctrl Alt B . Unlike bypassed FX, offline FX will consume no CPU.

Note: Any plug-in added to an FX chain will then be displayed in the FX Browser's **Recently Used** FX folder.

2.11 Using the Supplied FX Presets

To get started you might wish to explore some of the presets that come with these plug-ins. For example, **Cockos ReaDelay** includes presets which you can try with your various tracks. Simply display the drop down list and select the item that you want (example shown right).

Most of the Rea plug-ins include presets, which you can explore for yourself. Of course, you can also make any adjustments and changes to these that you like, in order to customize them more precisely to your own needs.

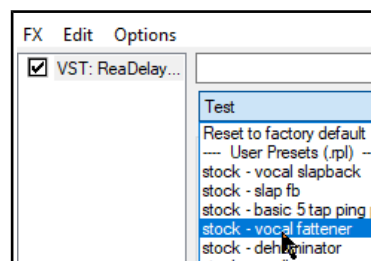

To set any FX preset as the default for that FX

1. Select the required preset from the drop down list.
2. Click on the **+** button to the right of the list and choose **Save preset as default** from the menu.
3. Type your own name for the preset and click on **OK**.

To download more presets, go to <http://stash.reaper.fm/> and follow the link to **FX Preset Libraries**.

To import downloaded presets into REAPER, follow this sequence:

1. Insert an instance of the plug-in into any track.
2. Click on the **+** button (next to the **Param** button in the FX Chain window).
3. Choose **Import Preset Library**.
4. Navigate to and select the required .RPL file then click on **Open** (or, to insert several files, use Ctrl click to build your list before clicking on **Open**.)

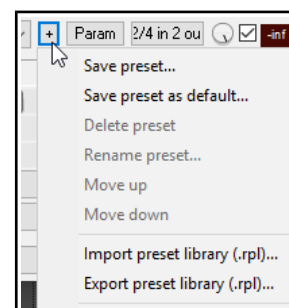

To select a preset when loading an FX

1. Open the track FX window and click on the **Add** button.
2. Select required category (e.g. Cockos) and required FX (e.g. ReaEQ).
3. Right click on the FX and choose **Add to...** from the context menu.
4. In the FX window, click on the **+** button then select the required preset.

2.12 Controlling Track FX

REAPER provides you with a number of tools to help you manage your Track FX. For example, you can:

- Change the order in which they are applied.
- Copy or move any FX from one track to another.
- Save (and retrieve) any sequence of FX as a chain that can be easily inserted into other tracks.
- Bypass individual FX or an entire FX chain.
- Specify a default set of FX to be automatically inserted into new tracks for your project.

REAPER Project Basics

In order to do this ...	You need to do this ...
Dock the FX Chain	Choose the FX, Dock FX Window in Docker command.
Adjust the values for track FX parameters	Drag with the mouse, or scroll mouse wheel over, the parameter control fader. For fine adjustments, hold Ctrl key while you do this, or click once on the control and use up/down keys on keyboard.
Adjust the wet/dry mix of any FX	Select the plug-in in the FX chain, then use the mouse to adjust the small rotary control next to the UI button, as shown here. 100% equals completely wet: 0% is completely dry. 
Change the FX Order	Drag and drop FX name up or down within the track FX window.
Float an FX window	Right-click on FX button in TCP and select the FX, or ... Double-click on the FX name in the FX Chain window (toggles). The title bar of the floated window will display the track name, the FX name, and its place in the track FX chain. For example: VST: ReaEQ, Track 1 "Vocal" [2/3] , i.e. the 2nd FX in a chain of 3.
Advanced floated FX window options	For more advanced floated FX window options, see the section Advanced Floated FX Window Options .
Keep FX/Add FX window on top	Click on the pin symbol at right of title bar.
Close a floating FX window	Double-click on FX window title bar.
Copy an FX (or FX selection) from one track to another.	Ctrl drag the FX from to the track panel to another track. To copy automation envelopes with the FX, use Shift Ctrl drag.
Move an FX (or FX selection) from one track to another.	Hold down Alt , drag the FX from the source track FX window and drop on the track panel for any other track.
Rename an FX Instance	Select the FX name in the FX Chain and press F2 , or right-click and choose Rename FX instance from the context menu.
Bypass an FX (toggle)	Click either the FX check box next to the FX name in the FX chain or the check box in the top right corner of the FX window.
Set an FX offline (toggle)	Ctrl Click either the FX check box next to the FX name in the FX chain or the check box in the top right corner of the FX window.
Replace one FX with another, preserving any existing routing configuration	In Track FX window, <i>either</i> click on Add to display FX browser. Select required FX, then Alt left drag to Track FX window and drop over the FX to be replaced, <i>or ...</i> Select the FX in the FX chain and press Ctrl R . In the Replace FX window (now displayed) double-click on the replacement FX.
Make the current track FX the default for new tracks	Within the Track FX window, choose FX, Save Chain as default for new tracks .
Open an FX from track panel	Right click on FX button, then left click on the required FX name.
Remove an FX from a track	Select FX in the track FX chain then click on the Remove button.
Remove all FX from a track	Hold Alt while clicking on the track's FX button in the TCP.
Search for an FX	Enter text in the Filter List at the bottom of the FX window.
Save the current sequence of Track FX as a chain	In the Track FX window, choose the FX, Save FX Chain command. FX parameter settings are saved with the chain.
Insert additional FX within an existing FX chain	Drag and drop the required FX from the FX window to the required position in the FX chain.
Save selected track FX as a chain	Select the names of the FX to be included in the chain (use Ctrl Click), then choose FX, Save Selected FX as Chain .

For a bound hard copy of the latest version of this User Guide (printed in B&W) go to LULU.com

Up and Running: A REAPER User Guide v 7.31

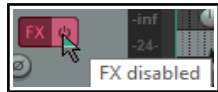
In order to do this ...	You need to do this ...	
Retrieve an existing previously saved FX Chain (from FX menu)	Within the Track FX window, choose FX, Add FX Chain command, or within the TCP right-click over the FX button and select Add FX Chain from the menu.	
Retrieve an existing previously saved FX Chain (from Media Explorer)	Drag and drop the chain from Media Explorer window: hold Alt key while dragging to replace existing FX.	
Save track FX as the default chain for new tracks	From the Track FX menu, choose FX then Save chain as default for new tracks .	
Load your default FX Chain	In Track FX window, click on Add then choose FX, Load Default Track Chain command.	
Access the FX Preferences settings	Within the Track FX window, choose the Options, FX Plug-in Settings command. These are discussed in Chapter 22 .	
Bypass all FX for a track	In the Track Control Panel, click on the FX Enable/Disable toggle button. Click again to reverse this.	
Bypass all FX (all tracks)	Hold Ctrl while clicking on FX Enable/Disable toggle button.	

2.13 FX Window and Keyboard Shortcuts

For your convenience the FX window makes various keyboard shortcuts available to you when you are working in it. These include navigation shortcuts (such as **Down** and **Up** to select next/previous FX in chain) and command shortcuts (such as **Ctrl S** to **Save FX chain...**). The command FX keys are displayed on the menus.

You might prefer to instead use these keys in arrange view even when you are working in the FX window, so that (for example) **Ctrl S** can still be used to save the project file and the **Down** and **Up** arrows to zoom out/in horizontally. In this case, you should enable the menu option **Ignore FX chain keyboard shortcuts (send to main window)**.

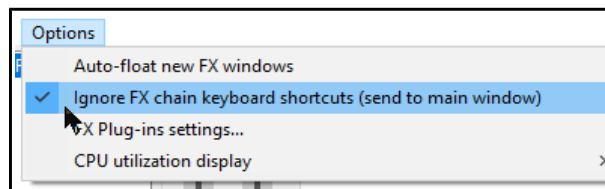

Example

In this example, we will create a default FX chain consisting of ReaEQ and ReaComp, both set to bypass mode.

1. Open any project file and add a new track at the end. We will use this track to create our FX chain.
2. Click on the **FX** button for this track to open the FX Window. In the first (left) column of the Add FX window, click on **Cockos**.
3. Select in turn, first **ReaEQ (Cockos)** and then **ReaComp (Cockos)**. In each case, either use the **OK** button to add the plug-in to the track FX chain, or drag and drop them into the chain.
4. Make sure that both these FX are unticked – this sets them to bypass.
5. Right click over one of the FX and from the context menu, choose **FX Chain, Save all FX as default for new tracks**.
6. Close the FX window. You can now exit REAPER if you wish. There is no need to save the changes to the project file.
7. Re-open REAPER, open any project file and insert a new track anywhere you wish.
8. Open the FX window for your new tracks. You should see that the two plug-ins, ReaEQ and ReaComp have already been inserted into this FX bin, in bypass mode.

Tip 1: If you wish to make changes to the contents of your default FX chain, simply repeat the process described above, this time with the changed set of plug-ins, or (to remove it) with no plug-ins at all.

Tip 2: If you hold down the **Ctrl Shift** keys when opening a project file, the file will be opened with its FX off line. This can be useful if you need to conserve CPU, or if there is a plug-in which might be causing problems.

REAPER Project Basics

Tip 3: If you switch the FX to bypass mode before saving your FX chain, then the FX chain will be saved in bypass mode. This means that the FX in your new tracks will not require any CPU usage until such time as you open the FX window and enable them.

2.14 Using an FX Bus

If you have used other DAW software, or an analog (tape) recording and mixing desk, you are probably already familiar with the concept of a **Bus**. The exact meaning of the term can have several variations, but most commonly (and in this example), a Bus is used to enable a number of tracks to share the same resource (such as perhaps Reverb or Chorus FX).

This saves on valuable computer resources such as CPU. For example, instead of requiring multiple instances of the same FX in perhaps three or four tracks or more, by using a Bus you can ensure that only one instance of the FX is required. Note that when you use a Bus in this way:

- The output of each track is still directed to the Master.
- In addition, a copy of the signal from each track is directed to the FX Bus.
- At some stage, the output of the FX Bus is then mixed back in with the original signal. Typically (and in the example shown here) this is achieved by directing the output of the FX Bus to the Master, although other more complex routing arrangements are also possible.

The Bus track can be inserted wherever you like. In this example, we will place it just after the last track. This example uses the sample project file **All Through The Night.RPP**. Open this file, then save a copy to a new name such as **All Through The Night with Bus.RPP** before embarking on this example.

We are now going to create an FX Bus and insert into that bus a Chorus effect. We will then ensure that both of our guitar tracks use the chorus.



REAPER differs from many DAWs in that it makes no inherent distinction between a Bus and a Track. The difference is determined solely by how you use it. For a more pleasing sound, you might wish to pan the guitar tracks have been panned somewhat to the left and right respectively.

To Create the Bus and add the FX to it:

- Select track 4 (in the Track Control Panel).
- To insert a new track either choose the **Track, Insert New Track** command, or press **Ctrl T** or double click in the vacant track control panel area beneath the last track.
- To name this new track, click in the area where the name is to go, type **FX Bus** then press **Enter**.
- To insert the Chorus FX into this bus, click on the bus's **FX** button. From the list of plug-in types, select **JS**, then in the list of plug-ins double click on **JS: Chorus (Guitar chorus)**. Close the FX window.

To Create Sends from the two guitar tracks to the Bus:

- To select the two guitar tracks in the TCP, click on the panel for Gtr Body, then Ctrl click on the panel for Gtr Neck. Right-click over the **ROUTE** button for either of these tracks.
- From the context menu, choose **Sends** then **Track 5: FX Bus**.

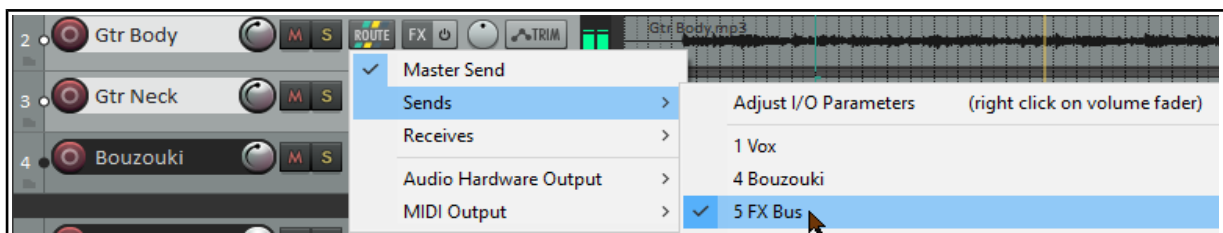

For a bound hard copy of the latest version of this User Guide (printed in B&W) go to LULU.com

Up and Running: A REAPER User Guide v 7.31

For every send there is an equivalent receive, and vice versa. For example, if you now open the Routing window for Track 5 (click on the track's ROUTE button) you will see that it has a receive from each guitar track. You'll learn more about REAPER's routing later in this chapter ([Routing Essentials](#)) as well as in [Chapters 5](#) and [17](#).

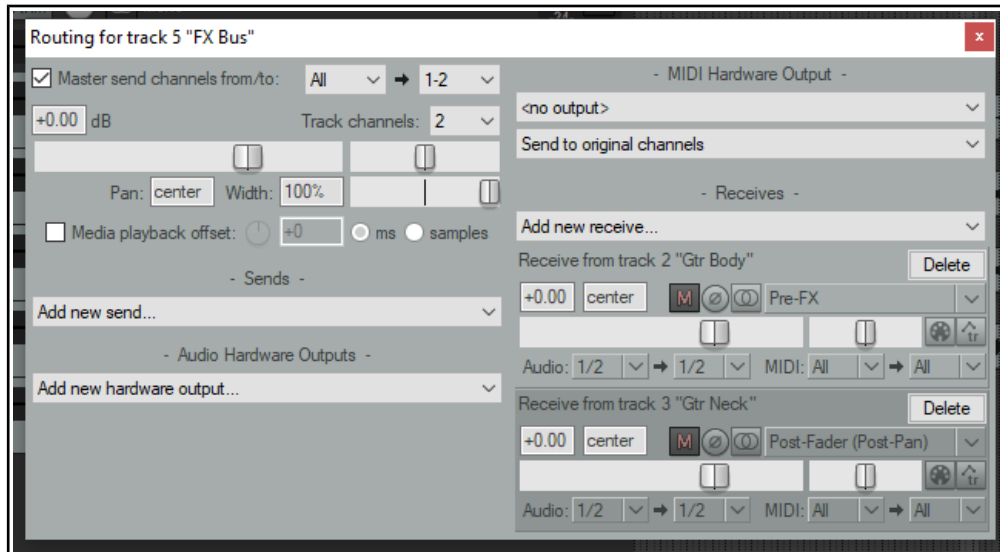

You might have noticed a **Media playback offset** option. This allows you to compensate for possible latency introduced by third party VST instruments. For now you can ignore this: it will be explained in [Chapter 10](#).

Making Adjustments

When you now play the song, you'll probably find that there's more chorus on the guitar tracks than you would like. There are four main ways to adjust this. Experiment until you find what gives you the results you want:

1. Adjust the chorus FX parameters. In this case, you could lower the amount of Wet signal in the mix.
2. Adjust the levels of one or both of the receives in the FX bus routing window.
3. Display the routing window for either guitar track and adjust the send levels for that track.
4. Adjust output volume fader for the track called **FX Bus**.

Speed Tips

In Order To Do This ...	Do This
Toggle on/off send from track to Master	Hold Alt while clicking on ROUTE button. Works with single track or multiple track selection.
Create a quick send on the fly from one track to another.	In TCP or MCP, drag and drop from send track ROUTE button to receive track's. See Chapter 11 for a the full range of options.
Send output of track or selection of tracks direct to any hardware output.	Select track(s). Right-click on ROUTE button and select Audio Hardware Output or MIDI output (as required) then choose from the sub-menu. This is independent of the track's master send status.

2.15 Managing the Play Cursor

By default, when a project is playing, pressing **Stop** (or **Spacebar**) will stop playback and return the play cursor to its previous starting position. Pressing **Pause** (or **Enter**) will pause playback at the current play cursor position.

You can also specify that the play cursor should be moved when you click on the Time Ruler, an empty area of any track and/or in the empty area below tracks. These three options can be enabled/disabled in your **Seek playback when clicked**. ([Options](#), [Preferences](#), [Audio](#), [Seeking](#) settings).

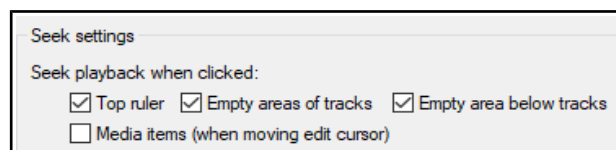

REAPER Project Basics

2.16 Analyzing FX Performance

FX plug-ins can impose a heavy load on your computer’s CPU. To help you overcome this, you can use the **Performance Meter** to closely monitor your FX in the following ways:

- You can check how much CPU is being used by the FX in your various tracks and in the master.
- You can disable and enable FX chains for individual tracks, quickly, easily and conveniently, all together in one place.
- You can toggle on and off the mute status for your tracks, again all in one convenient place.

To display the Performance Meter, press **Ctrl Alt P**, or use the **View, Performance Meter** command.

Example

In the example shown (right), the Master track with 3 plug-ins is using 0.05% and the Vocals, with four plug-ins, is using 0.23%. Media items on this track are using a further 0.01%.

If any track shows an unexpectedly high reading examine the track FX f to help identify the reason for this. To open a track FX chain, double click on the track name or number in the Performance Meter window.

This feature is useful if a project has many tracks. You can use the Performance Meter window to browse your project file, checking it track by track, without having to scroll or navigate thru Track View. You can also toggle FX Bypass for any track, selection of tracks, or all tracks in the **Track View** or **Mixer View**. The table below summarises these options.

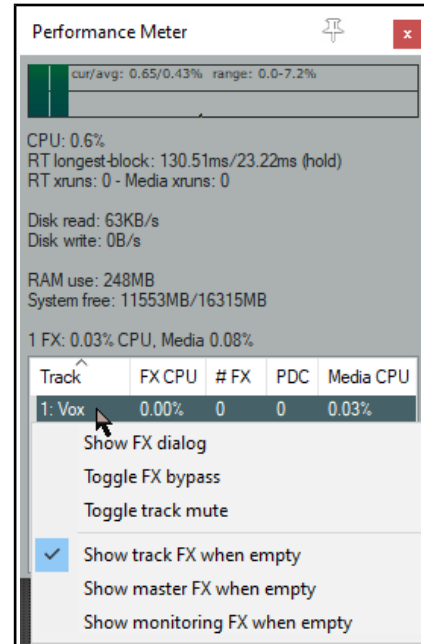

In order to do this ...	In Mixer or Track View, do this ...
Toggle FX Bypass On/Off for that track.	Click the FX Bypass button for any track.
Toggle FX Bypass On/Off for all tracks in the selection.	Select a number of tracks (Ctrl Click) then click the FX Bypass button for any track in the selection.
Toggle FX Bypass On/Off for all tracks.	Hold Ctrl key while clicking any track’s FX Bypass button.

The first of the performance meter’s two right click menus is accessed by right clicking in the track list area.

In order to do this ...	In the Performance Meter window do this ...
Open FX Window for that track.	Right click on track name, choose Show FX Dialog .
Toggle FX Bypass On/Off.	Right click on track name, choose Toggle FX Bypass .
Toggle track mute for that track.	Right click over any track, choose Toggle Track Mute .
Show in/hide from Performance Meter (PM) list tracks with no FX.	Right click on any track, enable/disable Show track FX when empty .
Show hide in PM master track/monitoring when these have no FX.	Right click on a track, enable/disable Show master FX when empty and/or Show monitoring FX when empty .

The other menu selects what you want shown or not shown in the window. Most options are enabled by default. Right click anywhere in the main Performance Meter area to display this. For example, you can choose to display (or not) the **CPU graph, Real time CPU on the graph, CPU use, Real time longest block processing time, Disk use, RAM use, Video load, FX and media item CPU use**, and more.

You can also use this menu to move the window to the docker.

Tip: You can select several tracks – using **Ctrl Click** – then right click over any of their track numbers in the Performance Meter to Toggle FX bypass and/or Track Mute status for all tracks in the selection.

Note: You’ll find more information about the [REAPER Performance Meter](#) in Chapter 22 of this guide.

2.17 Time Selections and Time Loops

You might need to work on just a part of your project for a while. To do this, first check the **Options** menu to see if **Loop Points Linked to Time Selection** is enabled. If it is, then making a time selection and defining a loop are the same thing. If not, then making a time selection and defining a loop become two different things. Either way, to define a loop area click and drag along the timeline. The start and end of the loop are marked by two small equilateral triangular indents.

- Stop the playback at or near the point where you want your loop to begin (or click your mouse in the background area) to move the Edit Cursor there.
- Place your mouse over the **Timeline** (above the first track), then click/drag along it, releasing the mouse to define the area to be looped. This is shown here. The start and end of the loop are marked by two small triangles. *If when you attempt this the selection snaps outwards to define a larger area than you want, then REAPER has snapping enabled.* Snapping will be discussed in detail in [Chapter 7](#): The shortcut keys **Alt S** toggle snapping on and off.

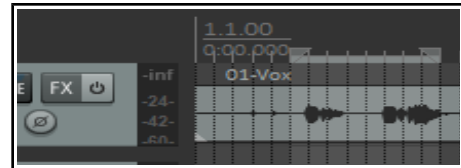

Tip: To set the loop selection to match a media item, hold **Ctrl** while you double click on that item. To set the time selection to match a media item, hold **Shift** while you double-click on the item.

Now when you play the project, provided that the loop (toggle repeat) button on the transport bar is engaged, it will replay over again the area selected for your Loop. If loop points are linked to time selection, the start time, finish time and duration of the selection are also shown on the **Transport Bar**. Pressing the **R** key toggles this repeat function on and off. There is also the option (under **Options, Preferences** on the **Playback** page) to stop playback at the end of a loop when the repeat function is disabled.

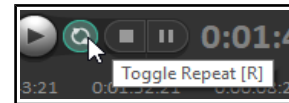

To change the area defined as your loop, repeat the original procedure. To clear the loop altogether, without defining a new one, press the **Escape** key.

If loop points are not linked to time selection, you can

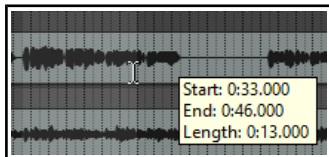
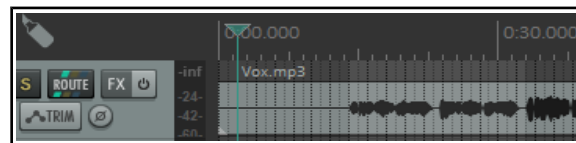

define a time selection by clicking and dragging in the space underneath or between the media items, in the arrange view background area.

Note that when you mark a time selection, a tooltip pops up which shows the start position, end position and length of your selection.

Right clicking on the Timeline then gives you a menu of commands which you can apply to a time selection, including **Zoom Selection**. You can use this menu to change the units used on the timeline – for example, **Minutes:Seconds, Measures:Beats, Measures:Beats ,a Measures.Beats (minimal), Measures.Beats (minimal), Measures.Fractions, Seconds, Samples, Hours:Minutes:Seconds:Frames** or **Absolute Frames**. You can also specify as a secondary time unit **Minutes:Seconds, Seconds, Samples, Hours:Minutes:Seconds:Frames** or **Absolute Frames**.

The other commands on this menu will be discussed elsewhere in this User Guide, as the need arises. These are features that you are likely to find useful when editing your files. Incidentally, to zoom out of a time selection and restore a whole project length to view, press **Ctrl PgDown**.

There's more about loops and time selections elsewhere in this guide, e.g. [Chapter 9](#).

2.18 Managing Time and Loop Selections

In the previous section you learnt how to click and drag within an empty area of the track view to define a time selection. This may or may not also change the loop selection, depending on your **Options, Loop points linked to time selection** setting. As you progress thru this User Guide, you will see that time selection plays an important role in REAPER, for example when it comes to editing your media items. You'll probably find at first that it's too easy to perhaps select too large an area, or to miss part of the area that you intended to select.

To modify a loop selection using the mouse, hover the mouse over the edge at the start or finish of the loop selection on the timeline, then click and drag left or right. Dragging left from the start of the selected area extends the selection left, dragging right shortens it. Dragging right from the finish of the selected area extends it to the right, dragging left shortens it. Holding **Ctrl** while you do this cause any snap settings to be ignored.

REAPER Project Basics

To move a loop selection, hold the mouse over the selected area on the time line, then hold down **Shift** while clicking and dragging the mouse left or right.

You can also modify a time selection by first clicking then scrolling the mousewheel over the Selection area of the **Transport Bar**. Scroll over the start area to adjust start time, end area to adjust end time, or over the length of selection area to move the entire selection. If you wish, you can enter actual times in the start and end time boxes. There are also several keyboard shortcuts you can use for managing **Time Selections**, summarised below. If loop points are linked to the time selection, then the loop area will also be modified.



Function	Keystroke
Nudge Entire Time Selection left a little.	, (comma)
Nudge Entire Time Selection right a little.	. (period or full stop)
Extend Time Selection to left by nudging left edge left a little.	Ctrl ,
Shrink Time Selection from right by nudging right edge left a little.	Ctrl Alt ,
Extend Time Selection from left by nudging right edge right a little.	Ctrl Alt .
Move Time Selection left by time selection length.	Shift ,
Move Time Selection right by time selection length.	Shift .
Copy portions of selected media items in Time Selection.	Ctrl Shift C
Remove (Unselect) Time Selection.	Esc
Zoom to Time Selection.	Ctrl PageUp
Zoom back to Project.	Ctrl PageDown

If you wish, you can use the keyboard rather than the mouse to manage your time selections. First you need to position the cursor at either the start or the end of the loop, then use one of these:

Function	Keystroke
Drag cursor to the left and create time selection.	Shift Left Arrow
Drag cursor to the right and create time selection.	Shift Right Arrow

Tip: If your cursor will not stay exactly where you wish when creating a selection, make sure snapping is off.

2.19 Navigating by Jumping

You can jump to any point on the timeline using the **View, Go To, Jump To** command or the keyboard shortcut **Ctrl J**. In typing the place to jump to you should use the same format as the timeline. In the example used here, the timeline displays Measures and below it Minutes and Seconds. You could therefore use either format, e.g. **33.1** or **1:04**.

To jump to an absolute position in a project, simply enter the required position as in the example shown.

To jump forward or back relative to the current cursor position, enter a **+** or **-** followed by a value – e.g. **-2.0**

To jump to a specific time in an item, type **I** followed by the time, e.g. **i0:30**

If you are using markers and/or regions, you can jump to any maker or region – e.g., typing M1 will cause it to jump to marker 1, R2 to jump to the start of region 2, and so on. [Markers](#) and [regions](#) are explored in Chapter 9.

Tip: Another easy way to open the Jump to dialog box is to double-click on the time on the transport bar.

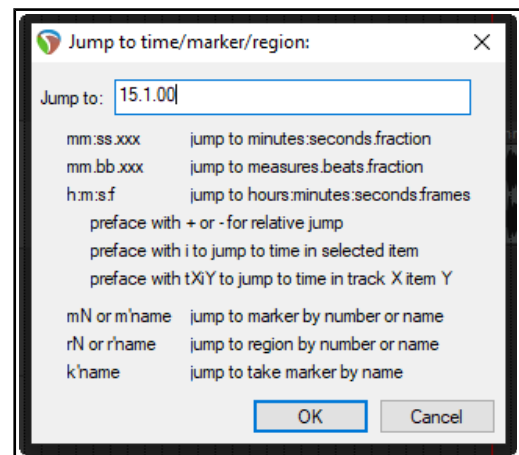

2.20 Time and Loop Selections and the Transport Bar

There are two special ways in which the transport bar can be used with a loop selection or a time selection.

In order to do this you should do this
Repeatedly play the selection over and over	Make the required loop selection, make sure Repeat is enabled (the button next to Record on the Transport Bar), position the play cursor within the loop and press Space .
Play back project skipping over time selection	Make the required time selection and position the play cursor anywhere before the start of that selection. Press Alt Space .

2.21 REAPER Routing Essentials

This section explains REAPER's **Routing**. Routing directs media output (audio and/or MIDI) to where you want it to go. You encountered a basic example earlier, when we looked at creating and using an FX bus. Routing can be very simple or extremely complex – and anything in between. This section explains basic routing concepts. More complex options will be covered later in this chapter, also in [Chapter 5](#), [Chapter 17](#), and elsewhere.

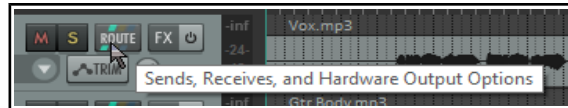

Each track panel includes a **Routing Button**. Hover the mouse over this button to display a tool tip listing any sends and/or receives associated with that track. Clicking the button opens the track's routing window. To close the routing window, **Escape**, or click on the **X** in the top right corner of the window, or click anywhere outside the window.

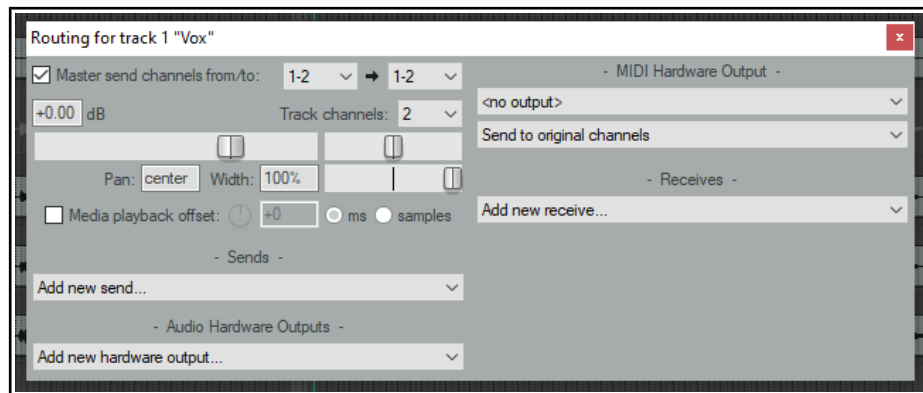

Routing window display

depends on project structure and DAW hardware setup (e.g. audio devices, MIDI devices). Depending on the nature of your project, your display should be *similar* to that shown here, but not necessarily identical. Note:

- **Master send channels:** these direct the track's output to the Master. In most cases you will want to direct the output of channels 1-2 directly to the Master, as shown for Track 1 (above).
- **Parent channels** - The example shown above directs audio to the master via channels 1 and 2 (stereo): this is the default. If you wish to send a mono signal to the master, select 1 from the first drop down, then a single channel from the parent channels drop down (e.g. channel 1 or 2 only).
- **Sends** – In the FX Bus example earlier in this chapter you created sends. A track's output can be routed via a send from any track to any other track or tracks. This topic will be covered in more detail later.
- **Audio Hardware Outputs** – as well as (or instead of) directing output to your Master Bus, you can direct output of any track directly to hardware outputs on your audio device. If this device has multiple outputs, this can be useful, for example, for creating a headphone mix, or a series of separate headphone mixes.
- **MIDI Hardware Output** – Directs MIDI output to an external device.
- **Receives** – For every send (source) track there will be a receive (destination) track. In the earlier example, the FX bus included two receives, one from each of the two guitar tracks in that project file.
- **Playback time offset** – Can be used to compensate for any latency that might be created (for example) by a third party VST instrument. See also [Chapter 10](#).

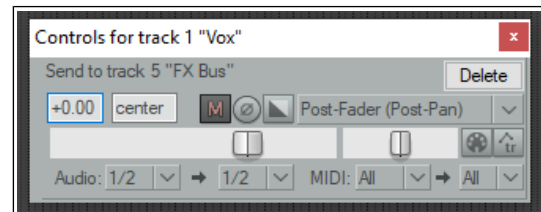

REAPER Project Basics

Notice (above) that a send includes volume and pan faders, and options to send audio or MIDI output, or both. When you create a new project, by default the output of each new track is routed to the Master track and from there to the output of your sound card. REAPER's routing capabilities go well beyond this. Below is an example of the Track Routing Window for a track for which both a **send** and a **receive** have been created. You will be shown how to do this later in this User Guide, starting at [Chapter 5](#).

The early chapters of this User Guide will take you thru basic track routing. After mastering these, you will find more complex examples in the later chapters, especially in [Chapter 17](#).

Note: Sends and Receives can be any of three types - **Post Fader (Post Pan)**, **Pre-Fader (Post FX)** and **Pre Fader (Pre FX)**. The differences will be discussed in [Chapter 17](#).

The default is **Post-Fader (Post Pan)**, but you can change this in **Options, Preferences, Project, Track/Send Defaults**. See also the flow charts in [Chapter 6](#).

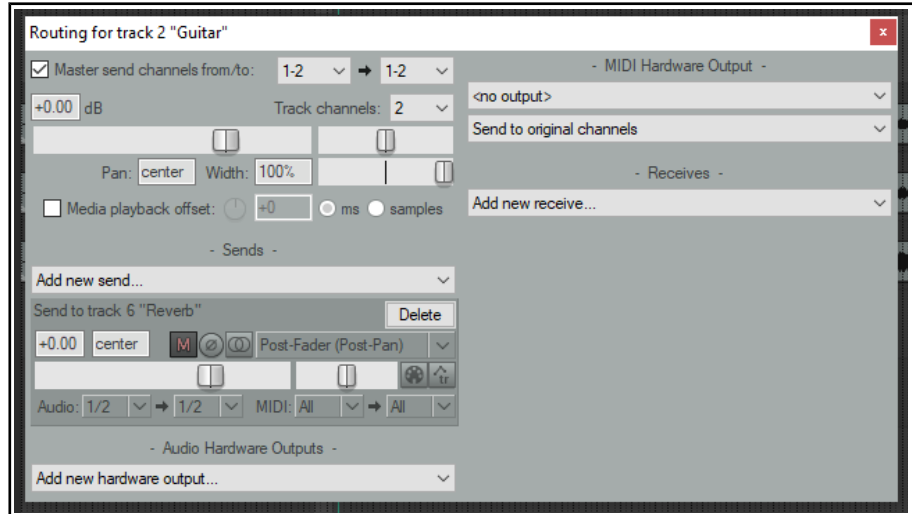

Tip: Drag and drop routing. A quick way to create a send from one track to another is to drag and drop from the route button on the source track to the track panel of the destination track -- see also [Chapter 17](#).

2.22 Showing Sends in the Track Panel

Options, Show sends in TCP (when size permits) displays your sends in the track panel (as shown here). You can make adjustments (without opening the routing window).

You can also click on the send to access all the send controls, or right click for a menu which includes **Mute send**, **Remove send**, **Show track routing window** and **Go to destination track**.

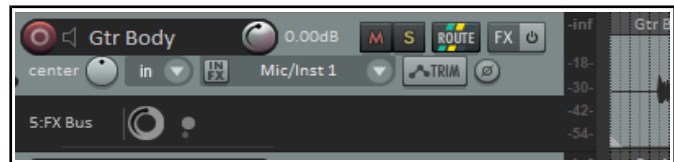

2.23 The Routing Matrix

REAPER's Routing Matrix is a one stop window where you can manage a project's entire routing needs. For example, you can add and delete sends and receives and manage their parameter controls.

Press **Alt R** to open the routing matrix. For the project file **All Through The Night with Bus** it should be similar to that shown here. Observe the cell

in the matrix where the **Gtr Body** row intersects with the **FX Bus** column. It contains two small blobs. By right clicking over this cell, you can cause the controls to be displayed which determine how the signal from the Gtr Body track is sent to the FX Bus (see above).

REAPER's Routing Matrix default display of paired outputs might include several that you do not want. You might want to only "natural" pairs (e.g. 1/2 for your speakers, 3/4 for a headphone amp). Non-standard pairs like 2/3 can be removed using **Options, Preferences, Audio**. Turn off **Show non-standard stereo channel pairs**.

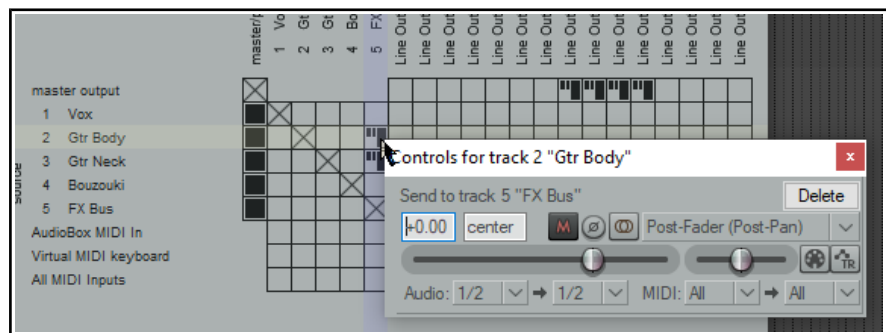

2.24 Managing Tracks

You have already encountered basic REAPER track management features, such as Volume, Panning, Mute and Solo. We can now explore these features in more depth and introduce others, e.g. moving and removing tracks, track folders and track grouping.

Many of the relevant commands and actions are available from the menu that is displayed when you right click over any track number (see right). **Ctrl Z** can be used to undo your last action.

PC or Mac?

Booster keys are used frequently throughout this User Guide. Booster keys on the macOS are not the same as they are in Windows (PC). This user guide references PC (Windows) booster keys. For OS users, please refer to the table in [Chapter 1, Selections, Controls and Commands](#) for a table of booster key equivalents.

Tip: Before continuing, you might wish to open the project file **All Through The Night.RPP** and save it to a new name, e.g. **All Through The Night EDITS.RPP**. You can use this file to experiment with some of the ideas presented in this section.

Basic Track Management

A number of techniques can be used for carrying out these various track management tasks.

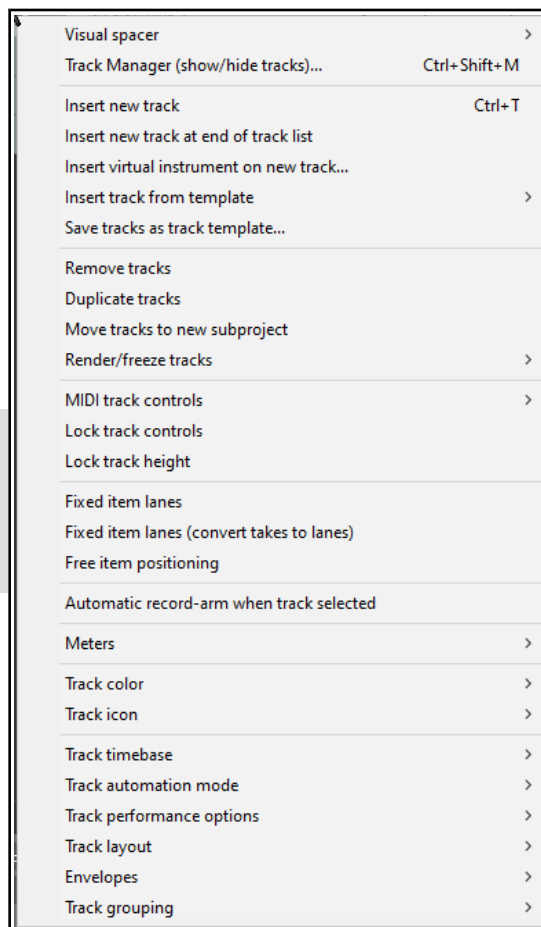

To do this ...	You should do this ...
Move a track up or down the track order	Click inside the track panel and drag the track up or down the track list until the cursor is just inside the required track, then release the mouse. Media items are moved with the track. Make sure the mouse displays a hand before you release it. 
Move two or more adjacent tracks up or down	Click in the first track panel as above, then hold Shift while clicking likewise inside the panel of the last track to be selected. Release the Shift key, then click and drag up or down. Media items move with the tracks.
Delete a track	Click on or around the track number, the press Delete , or right click and choose Remove tracks . All media items are removed with the track.
Delete two or more tracks	Use Ctrl click to make your selection, then press Delete , or right click and choose Remove tracks . Media items are removed with the tracks.
Copy a track or tracks as the next track(s)	Select track(s). Right click on one, choose Duplicate tracks . Media items are duplicated with the track.
Copy a track to a specified location	Click on the track number. Press Ctrl C . Move to the required location then press Ctrl V . All media items are duplicated with the tracks. To do this with more than one track, select all required tracks first.
Display the Master in Track View	Right click anywhere in the Track Control Panel area, below the last track. Choose Show master track , or use the keys Ctrl Alt M to toggle.
Make the Track Control Panel wider/narrower	Click and drag right/left on the boundary between the TCP and the arrange area. A narrow TCP might cause some controls to be hidden.

REAPER Project Basics

2.25 Keeping a Window on Top

The small pin on a window's title bar (just before the **X**) can be used to keep it on top. Click to toggle its on top status on and off (as shown here).



2.26 The Track Wiring View

Until now, there have been three main ways of managing track routing within REAPER, i.e. drag and drop in TCP or MCP view, using a track's routing window. Or using the Routing Matrix.

Now you have a fourth option – Track Wiring. Track Wiring view cannot just be used to create routing: it also gives you an overview of your project's routing, and allows you to manage it. For example, it can help you to identify any routing you may have created and forgotten about, but which needs to be deleted.

This section introduces you to Track Wiring and explores its environment. Track Wiring is accessed directly from the **View** menu. Let's start with a simple example.

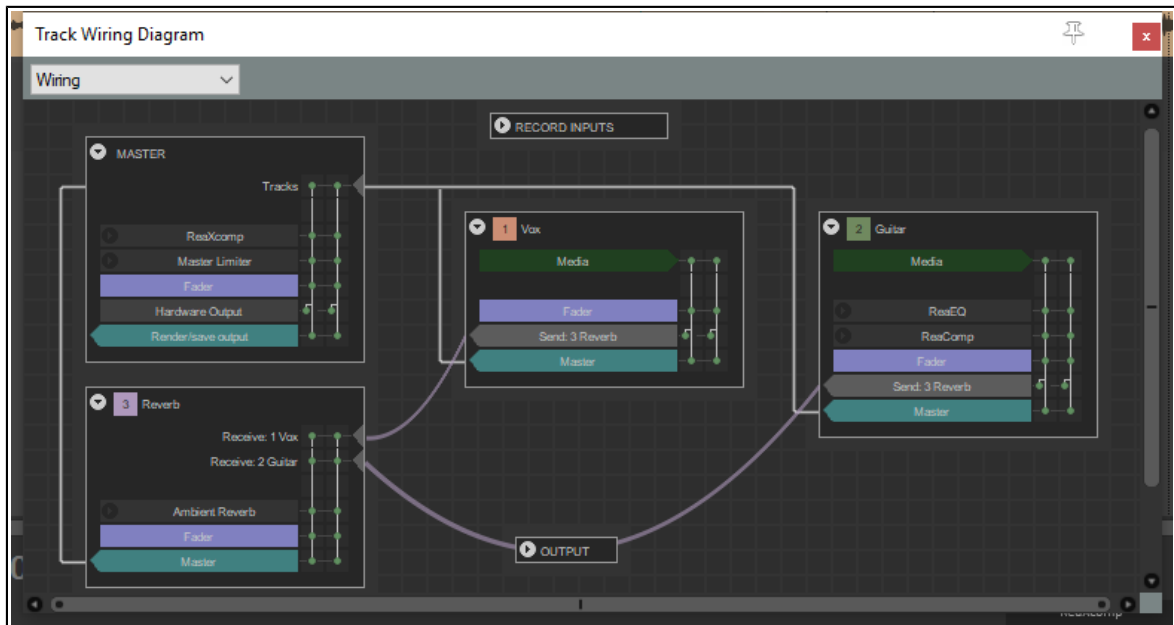

Above you see the track wiring view for a project with two recorded tracks and one reverb track.

- The solid straight white lines depict sends to the master.
- Click and hold on any track name to drag and drop it around at will.
- The curved lines represent sends from one track to another (from each recorded track to the reverb track).
- The little arrow next to the track number can be used to collapse/expand the display of detailed track information for individual

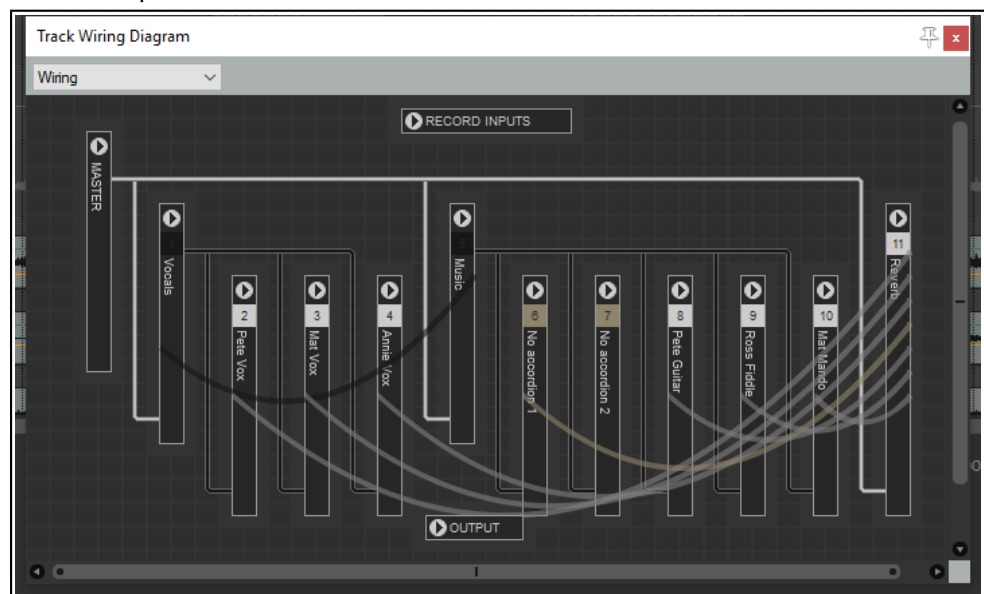

For a bound hard copy of the latest version of this User Guide (printed in B&W) go to LULU.com

Up and Running: A REAPER User Guide v 7.31

tracks. This can be especially useful if your file has a large number of tracks and/or more complex routing (as shown in the second example above). Notice also how the two folders (Vocals and Music) and their child tracks are depicted.

In "normal" mode for each track the following overview information is displayed: track number and name, media, fx, fader information, channels and any sends. Here is an example (right).

The Gtr Neck track shown here contains media, one FX (ReaComp) one send (to the Reverb track) and a send to the master. It uses two channels (hence the two vertical lines on the right).

The Reverb track contains no media, has receives from tracks 1 and 2, contains ReaVerbate and also directs its output to the master.

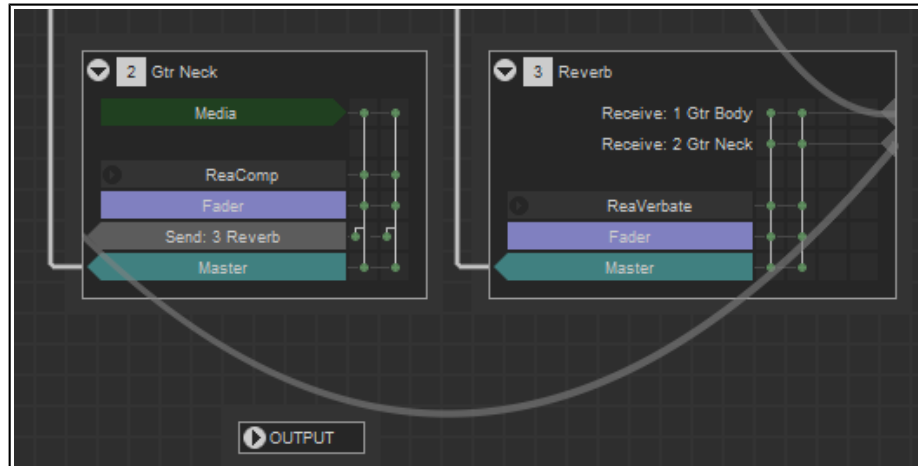

- Click on any FX name to open its UI – you can then adjust any of its parameters, and/or access its the pin connector. Click where shown here (right) to show all routing information for that FX.
- Click on the text "Fader" to open the routing window for that track: this has the same effect as clicking on the Route button in the TCP or MCP. You can modify, add or delete track sends and/or receives.
- You can click and drag in Track Wiring view to create new sends between tracks. The send type will be determined by exactly where you position the mouse before dragging:
 - Hover the mouse over the "body" of any track box (see below right) to see three boxed tiny + symbols on the left side of the track box.
 - Click and drag from the symbol beside the first FX in the FX chain to the destination track to create a Pre fader (Pre FX) send.
 - Click and drag from the symbol beside the box labeled "Fader" to the destination track to create a Pre fader (Post FX) send.
 - Click and drag from the symbol beside the box labeled "Master" to the destination track to create a Post fader (Post FX) send.

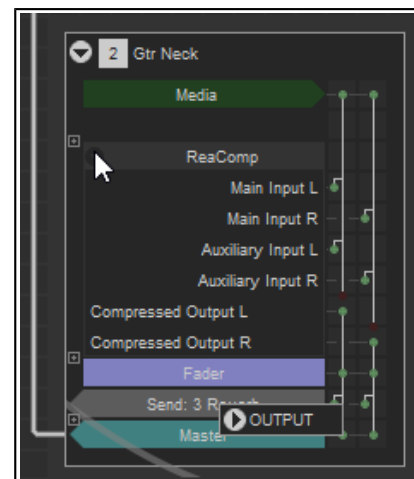

You can also modify MASTER settings in Track Wiring view:

- Click on any FX listed within the MASTER box to open its UI, where you can adjust any of its parameters.
- Within the MASTER box, click on the text "Fader" to open its hardware outputs window, Here you can add, adjust, or remove hardware outputs.
- Within any track box, click on the text "Send" to open its control window. You can modify or delete this send, e.g. to change the send type, adjust volume and/or pan, or specify destination channels.
- The more complex the project, the more complex the track wiring diagram. This is where the context menu can be helpful. Right click anywhere in the Track Wiring window to display the menu shown below.
- You can "unclutter" the diagram using any or all of the three toggle options shown:

Only show wires on track on mouseover

Only show hardware output/input wires on track mouseover

Show routing controls when creating send/hardware output.

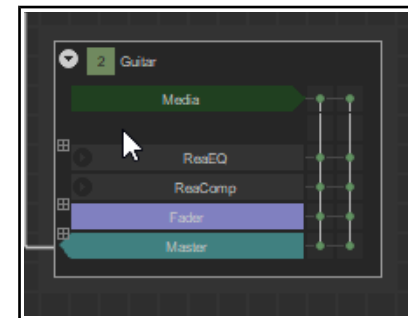

REAPER Project Basics

- If you get into a tangle after dragging and dropping **Reset all track positions** will get you out of trouble!
- The option **Show input activity indicators**, if enabled, will cause MIDI and audio inputs to light up in response to any input signal.
- You can use the dropdown list (top left corner of window) to switch between any of the four listed view modes - routing matrix, wiring, track grouping matrix, and region render matrix. This can be especially useful for switching between the track wiring diagram and the routing matrix.

This menu includes an option to Dock /Undock the window. Docking is explained ibelow.

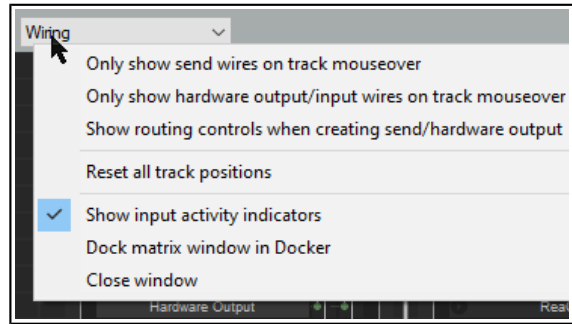

2.27 Docking and Floating

REAPER's docker can help you to avoid screen clutter. Right clicking over the title bar or background area of most windows opens a context menu relevant to that window. Look for either the option **Dock in Docker** or **Dock Window**. When multiple windows are docked, at the foot of the Docker you will see a series of tabs, used to select which window is displayed at any time.

- If a Window is closed while it is closed, next time it is opened it will still be docked.
- To undock a window, right click over the background or tab area of the window and deselect the **Dock in Docker** or **Dock Window** option.
- The Docker can itself be attached to the main window or detached and floated. Click over the small exclamation mark in the bottom left corner of the Docker and use the option to **Attach Docker to Main Window** to toggle.

By default the docker will be attached to the bottom of the main window. You can use the same menu to change this position to left, top or right.

- Clicking over the exclamation mark after detaching the Docker from the Main Menu will also give you access to the **Set Opacity** feature. This can be used to ensure that when floated and not in focus, the Docker is transparent. Opacity can be set between 25% and 100%.

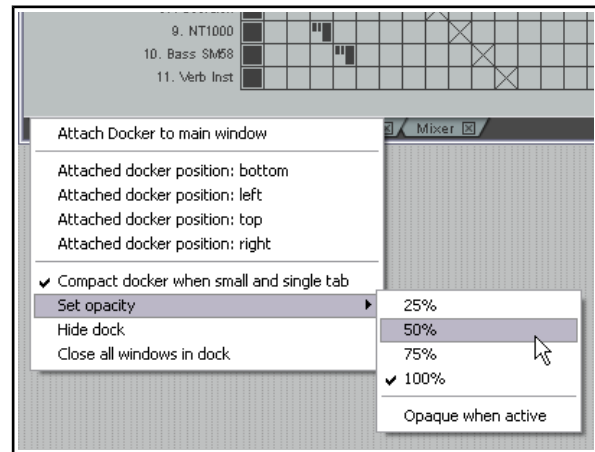

Tip: The keyboard shortcut **Alt D** can be used as a toggle to show or hide the Docker or Dockers.

For more experienced users, you can work with [multiple dockers](#) (see Chapter 12).

As an alternative to docking windows, you can use the toggle command **View, Show/hide all floating windows** to manage screen clutter. Another useful command can be **View, Cascade all floating windows**.

2.28 The Undo History Window

REAPER's Undo feature is very powerful. The **Edit, Undo History** command (or use **Ctrl Alt Z**) toggles open and closed the **Undo History Window**.

The **Undo** settings page of **Options, Preferences, General** includes options to manage your undo history. Settings options are shown below. In particular, you can:

- Specify the maximum amount of memory to be allocated to Undo.
- Specify whether to include item, track, envelope point and/or time selection and/or cursor positions changes in the undo history.

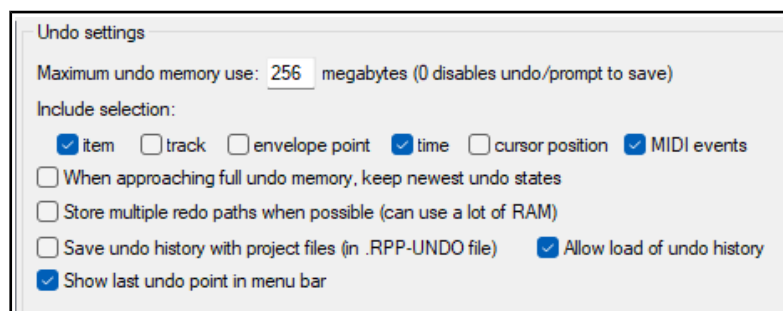

For a bound hard copy of the latest version of this User Guide (printed in B&W) go to LULU.com

Up and Running: A REAPER User Guide v 7.31

- Ensure that if the allocated undo area becomes full, the most recent actions will be retained.
- **Save your Undo History with the Project File** to ensure that this file is loaded with the project. Even at some later date, you will still be able to revert the project to an earlier state if you wish.
- **Store multiple undo/redo paths.** You can even store alternate sequences of commands and actions, then switch between them!
- **Show last undo point in menu bar.**

You can double click on any event displayed in the undo history window to **load that undo state**. This option is also available on the undo history window's right-click menu. Other menu options include **Remove selected state(s) from undo history** (can apply to a selection of actions), and **Dock/ undock the undo history in the docker.**

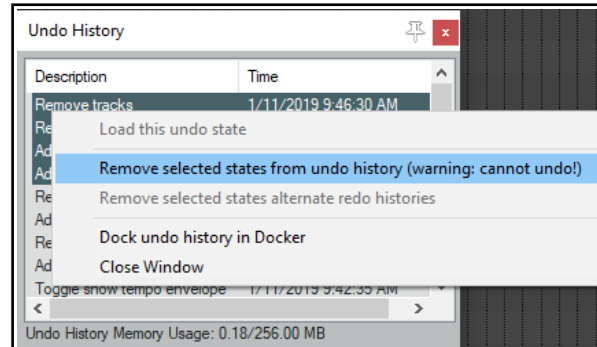

2.29 Multiple Project Tabs

Project tabs allow you to keep several projects open at the same time, thus enabling you to jump between different projects when working on more than one song, or to move or copy media items (audio and/or MIDI) from one project to another. To create a new project tab when you already have one file open, simply use the **File, New Project Tab** command (**Ctrl Alt N**). A new tab will be opened (labelled **Unsaved**), but the previous project will also remain open on a different tab. You can jump between projects simply clicking on the tab.

To open a file in an existing project tab, select that tab, then use the **File, Open Project** command in the usual way. To open it in a new project tab, select this option from the dialog box when opening the project. Right click over any project tab for the project tab menu:

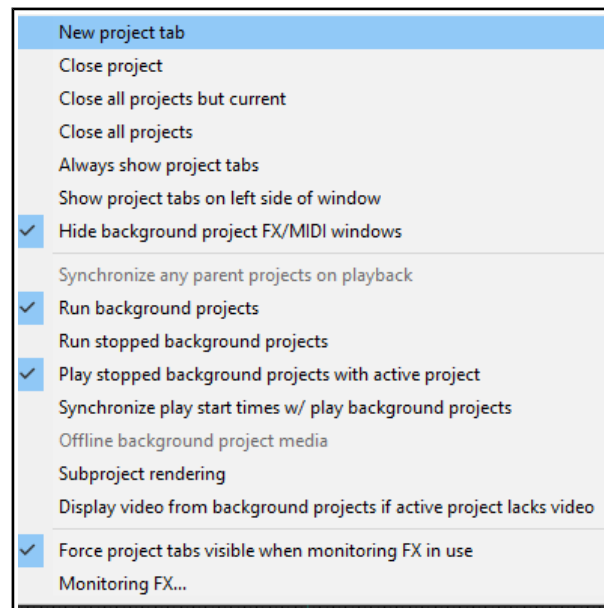

New project tab. This inserts a new tab. A quicker way of doing this is to double click in the project tab area to the immediate right of the last tab.

Close project. Closes the current project and its tab - or click on the **X** at the end of the tab.

Close all projects but current. Closes all project tabs except current one.

Close all projects. Closes all open projects.

Always show project tabs. Shows project tabs, even if only one project is currently open (toggle).

Show project tabs on left side of window.

Toggles displays tabs on left of window..

Hide background project FX/MIDI windows. Ensures that when one of a number of open project tabs is selected, any open FX windows etc. belonging to other open projects are not displayed on top of it.

Run background projects. This allows you to play the project in one tab while working on another.

Run stopped background projects. Commences playback of projects in tabs not currently selected.

Play stopped background projects with active project: Causes background projects (open on other tabs) to be played with the current project. When this is enabled, you can also select

Synchronize play start times w/play background projects. This will ensure that all open projects are played/stopped in synch.

Offline background project media will set media items in background projects offline.

To copy or move tracks and/or items from one project to another, first select the required tracks/items, then press **Ctrl C** (copy) or **Ctrl X** (cut). Next, click on the tab of the destination project and press **Ctrl V**.

There is a **Subproject rendering** submenu with four options – **Do not automatically render subprojects**, **Prompt before automatic render**, **Defer rendering of subprojects**, and **Leave subproject open in tab after automatic open and render**. Subprojects and these options are explained in [Chapter 12](#).

REAPER Project Basics

Display video from background projects if active project lacks video. See [Chapter 20](#).

Force project tabs visible when monitoring FX in use. Displays tabs whenever FX monitoring is active.
Monitoring FX ... This opens the [monitoring FX window](#).

Tips: Multiple project tabs can be reordered using drag and drop. Also, you can use the **File, Close All Projects** command to close all open projects at once. Note that the small **X** button used to close a project tab can be positioned to the left or the right: just drag and drop according to your preference.

A project can be opened on a new project tab directly from the **File, Recent projects** menu by holding down the **Shift** key while clicking on the project file name. You can open several projects together at the same time, each in its own project tab, provided all the .RPP files are in the same folder. Simply use the **File, Open project** command, then navigate to the required folder. Use **Ctrl Click** to build your selection, ensure **Open in new project tab** is ticked, then click on **Open**.

2.30 Item Names, Buttons and Icons

Depending on [Appearance, Media](#) preference settings, you may (or may not) see item names displayed above the media item rather than on it (see right).

You might also see some media item icons (or buttons). You'll learn more about this when we examine media items in [Chapter 7](#).

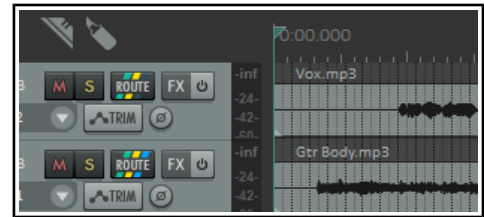

2.31 Online and Offline Media Items

By default, REAPER sets all media items offline when the program loses focus. This can be changed by disabling the option (**Options, Preferences, Media**) to **Set media items offline when program is not active**. You can also use the **Item, Media** command from REAPER's main menu to set all or selected media items online or offline should you wish or need to do so.

If any media items are still flagged as offline even when REAPER is active, or when a project is loaded, this is likely to mean either that the media files are to be found in a directory and/or drive other than the project directory, or that it has been deleted altogether. Note that REAPER's editing is will never delete files.

2.32 Advanced Track Settings

Time to get technical! A number of technical settings are available for individual tracks: if you find yourself getting out of your depth at all just steer clear of those settings and accept the project defaults.

Timebase: The project timebase is determined in your [project settings](#): as the wording implies, this becomes the default timebase for the entire project. However, you can change this for individual tracks via the context menu **Track timebase** command. Options are **Time**, **Beat (position, length rate)**, or **Beat (position only)**.

Other settings can be found in your global preferences – **Options, Preferences**, or **Ctrl P**.

[Media buffering](#) for the project can be set in your [Audio Buffering](#) preferences. To override these for individual tracks, choose **Track performance options** from the track's context menu. Here you can also enable or disable [anticipative FX](#) for the individual track.

There are also options to **Enable/disable track metering** (enabled by default) and [Prevent spectral peaks/spectrograms](#) for the individual track.

2.33 Reset REAPER to Factory Defaults

If you get into a mess with your preferences and settings, you might want to consider resetting REAPER settings to their factory defaults. Windows users should click the Start button, then scroll thru the list to find REAPER (or REAPER64), then choose **REAPER (reset configuration to factory defaults)**.

Before doing this, however, it might be advisable to [export your current configuration settings](#), in case you later change your mind. However, consider trying **REAPER (create new project)** in case your problems lie with something in the project that you last used.

2.34 The Big Clock

The **View, Big Clock** command (**Alt C**) toggles on/off the display of the Big Clock which displays the current position of the edit cursor.

It can be sized and moved at will, or docked in the docker. Right click over the Big Clock for a context menu of options (see right).

You can:

- ◆ Specify units to be used for display such as Minutes:Seconds, Minutes:Beats, Samples, Absolute frames.
- ◆ Select text and background colors
- ◆ Select a background image to be displayed.

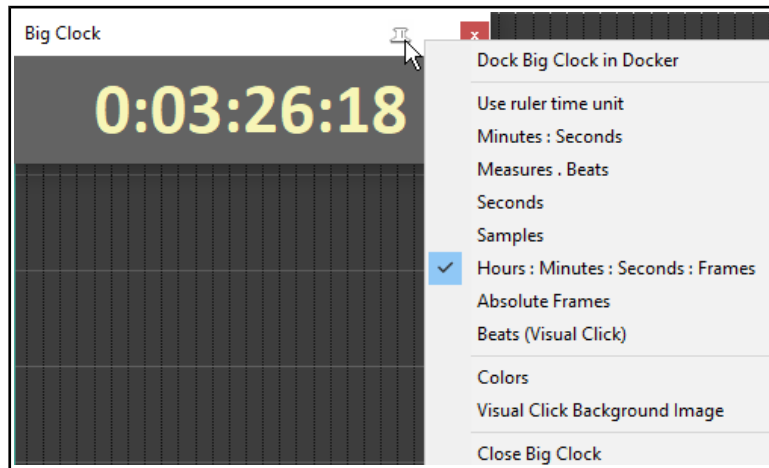

3 Recording Audio and MIDI

This chapter will take you thru what you need to know to get started with recording in REAPER. At the end of the chapter, you will find a helpful checklist.

3.1 Creating a New Project

To create a new project file, you can either use the **File, New Project** command, or press **Ctrl N**.

The **Project** page within the **Options, Preferences** dialog box can be used to determine how REAPER behaves each time you create a new project:

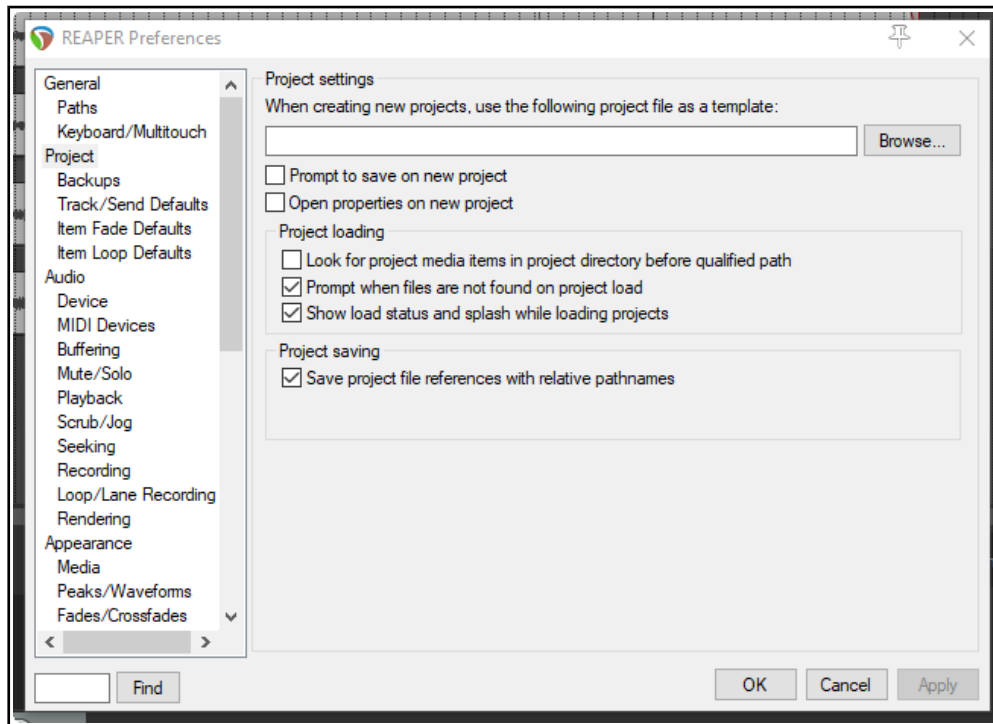

Amongst the most useful options on this screen are the following:

- **Use project file as a template.** This enables you to use an existing project file as a template for new projects. All tracks, FX, tracks, buses, routing etc. will be copied into the new file from the template file.
- **Prompt to save on new project.** If you enable this option, you will be prompted to save your new projects immediately they are created.
- **Open properties on new project.** If this option is selected, the **Project Options** dialog box will automatically be displayed every time you create a new project. This can help ensure that you select the correct recording format and other settings that you require.

In addition, the **Options, Preferences, Project, Backups** (See [Section 22.3.1](#)) page offers you various options for backing up your projects, such as:

- **Whether to preserve previously saved versions of the project.** This helps protect you against accidental loss of work. There are several options for managing this
- **Whether to automatically save to a timestamped file at intervals you specify.** Again, there are several options for how you would like to implement this. T

This can help to protect you from the consequences of an unforeseen circumstance such as a power outage or a computer crash. You can save these files to the **project directory** and/or an **additional directory**. You can also specify the frequency (in **minutes**) of automatic saving, and whether to apply this **when not recording**, **when stopped**, or at **any time**.

3.2 Setting Media Project Options

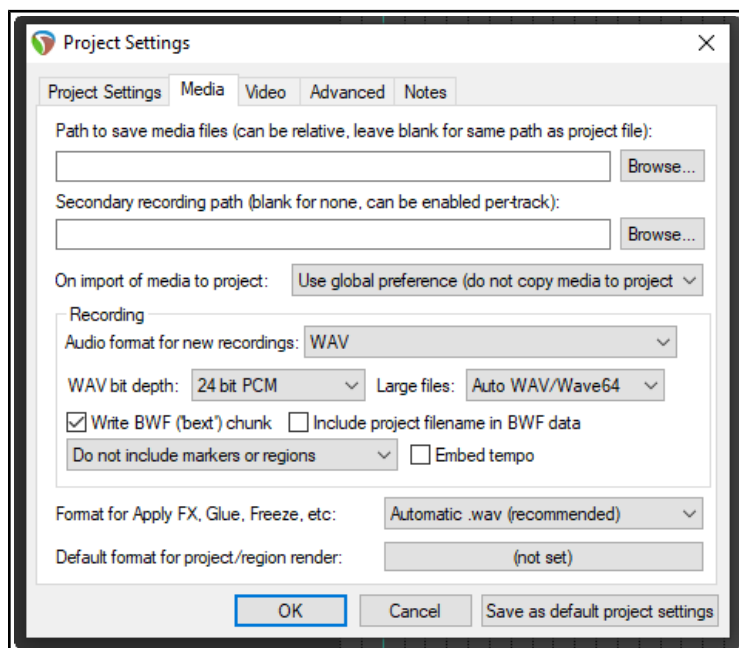

You can display the file's **Project Settings** window – **Alt Enter** – to ensure you are using your preferred **Media Settings**. In particular, check the **audio format**. If you are not sure, for CD quality select **.WAV**, with settings similar to those shown here. If you wish later to use some other format (such as **.MP3**) you can render your files in that format.

The settings shown would be suitable when the output is to be rendered to CD audio. As a rule, 24 bit is preferred for recording, 16 bit for rendering. If the recording is to be finalised in DVD format rather than CD, you should consider a sample rate of 48000 instead of 44100. This is specified on the main **Project Settings** page.

Some people prefer to sample at 88200 for CD and 96000 for DVD. Increasing sample rate also increases media item file size and might slow down processing.

Other formats.

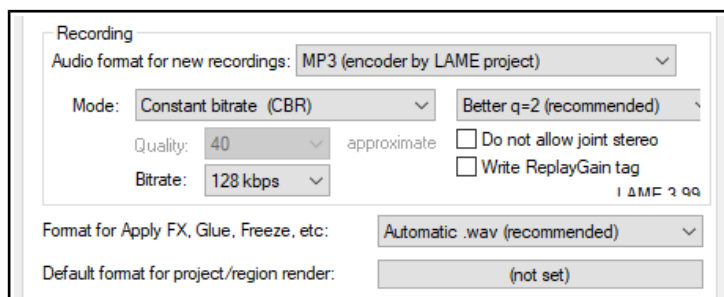

You can record using any of a number of compressed formats, including MP3, OGG and WavPack. Any of these will present you with further options appropriate to that format. For example, for MP3 you will need also to specify your required bitrate.

There is also a drop down list where you choose to write as cues to your recorded media files markers and regions, either one of these, or none of these, or only

markers/regions whose name begins with #. See Chapter 9 for more about [markers](#) and [regions](#).

3.3 Saving the Project File

After creating a file, use the **File, Save Project** command (or **Ctrl S**) to save it. You will need to specify a project file name. When saving a new file you are offered a number of options.

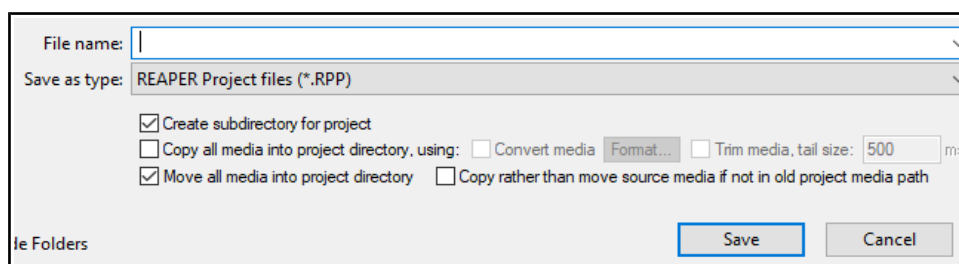

You can choose to **Create subdirectory for project**. If you also select **Copy all media into project directory** you may also specify a format for these items to be converted.

If you select **Move all media into project directory**, then by default all media files used by the project will be moved into the project subdirectory. Optionally you can ask to **Copy rather than move source media if not in old project media path**. You would be likely to choose this, for example, if your project uses files from a samples library, to ensure that the samples are not removed from the library.

You should also make sure that you get into the habit of frequently resaving your project after making changes. The easiest way to do this is simply to press **Ctrl S**.

Recording Audio and MIDI

3.4 Creating and Naming Tracks

After creating your project file you can create a track or several tracks for recording. A project can contain as many or as few tracks as you want. You can add tracks using the **Track, Insert New Track** command, by pressing **Ctrl T**, or by double-clicking in the empty track panel area. The new track is inserted immediately below any currently selected track. If you wish to insert a track after the last track, double-click in the track control panel after the last track or choose **Track, Insert new track at end of track list** from the main menu,

It is advisable to name the tracks before you start recording. Double-click in the track name area, type the name and press **Enter**. The media file created when you record will then be given a name that matches the track.

Under **Options, Preferences** you can display the **Recording** settings page and select from the **Wildcards** list any other items to be automatically included in your track's file names.

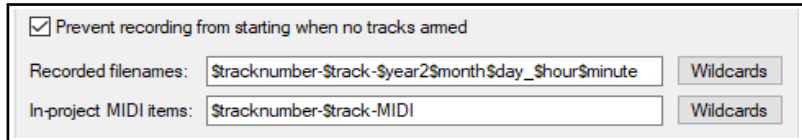

These can for example include track

number and the date and time of the recording. We'll look at more of these recording preferences shortly.

REAPER supports multitrack recording. The number of different sources that you can record at the same time is limited by the number of enabled inputs (under Preferences, Audio, Device) on your audio soundcard. Before commencing recording, for each track you will need to:

- Arm the track for recording.
- Assign the Input that is being used.
- Check that the sound level is right for recording.
- Check your input monitoring setting (default is on).
- Optionally, select a format other than the default.

REAPER's **Preferences** include **Project Track/Send defaults** which you can use to set track defaults (e.g. default volume fader level). These are explained in Chapter 22.

Note: You do not need to specify whether a track is to be stereo or mono. When assigning the track input for recording, you can use either a single mono input or a stereo pair. Stereo and mono tracks can be panned between the left and right speakers as you wish. Panning is discussed throughout this guide, e.g. in [Chapter 5](#).

3.5 To Prepare and Record One Track

Before commencing this exercise, make sure that the default track type is set to normal. This is how REAPER is set up to work "out of the box." You can make sure by going to **Options, Preferences, Project, Track/Send Defaults** and making sure that neither Free item positioning nor Fixed item lanes are enabled.

1. Check the **Options** menu to make sure that **Record mode: Normal** is selected. We'll examine the other modes as this chapter progresses.
2. Click on the **Record Arm** button for that track (on the left) The button should now appear red. If using the REAPER 7 default theme, this will also make the **Input settings** button visible.
3. Click the mouse over the **Input settings** for that track to display a menu. Menu options will be determined by your sound card and audio device(s).
4. Select the required input from the menu. This will be the one to which the microphone or line that you are using for recording is connected. In most cases, this is likely to be one of the **Input: Mono** options. If you are not sure which option to pick, choose **Mono** when recording from a single microphone or lead.
5. By default, **Input Monitoring** should be on. This is the first item (**Monitor Input**) on the **Record arm** button right-click context menu. If your sound card supports direct monitoring you will probably wish to use that, in which case you should turn off REAPER's input monitoring. Check the sound card's documentation.. If your card does not support direct monitoring, then you should leave REAPER's input monitoring enabled. There's more about input monitoring in sections 3.14 and 3.15.
6. Audition the sound while you adjust the volume on your audio desk or sound input device, so as to get a good strong signal without clipping. If in doubt, aim to peak at about -10dB. *Note that the recording level cannot be controlled by adjusting the Track's volume fader: that controls only the playback level.*

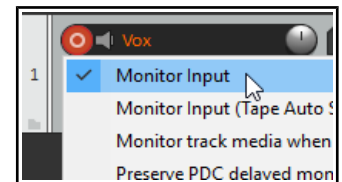
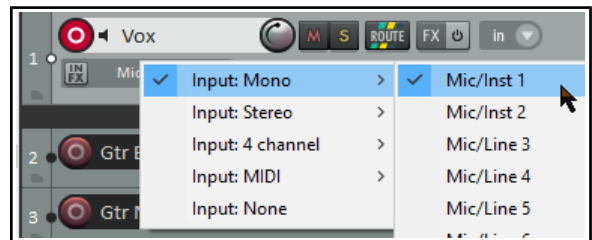

Up and Running: A REAPER User Guide v 7.31

7. Press the **Record** button on the **Transport**, or use the keyboard shortcut **Ctrl R**.
8. To finish recording, either press **Stop** on the Transport, or press **Space**, or press the **Record** button again, or press **Ctrl R**. Now click on the **Record Arm** button for this track to “disarm” it.

Tip: The Input menu (shown above) includes an item **Input: None**. This can be used to prevent material from ever being accidentally recorded onto a track where it is not wanted, such as perhaps an FX bus or a folder.

Note 1:

If you use the **Record** button or **Ctrl R** to stop recording, recorded items are automatically saved.

If you press **Space** or **Stop**, the dialog box shown will let you save or delete any or all of your newly recorded media items.

Note 2:

REAPER supports “on the fly recording”.

This means you can also arm additional tracks after the recording has started.

Those tracks will then also be recorded from the point at which you arm them.

Similarly, if recording more than one track, you can stop recording one while continuing to record the others by clicking on the **Record Arm/Disarm** button to disarm just that track.

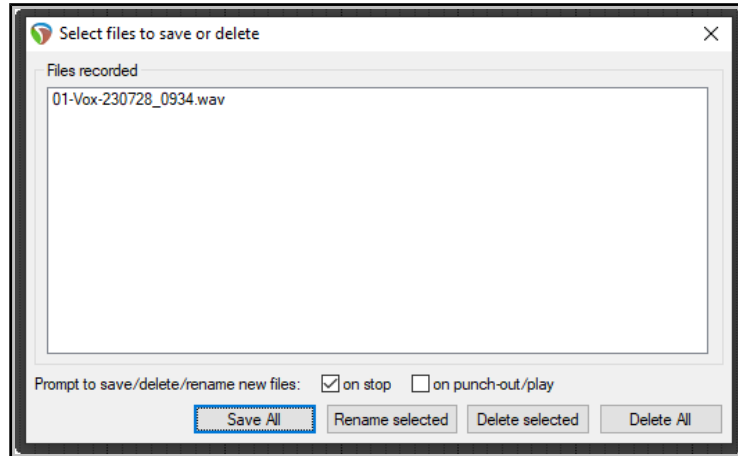

Tip: Track/Send Default Preferences. The **Track/Send** Defaults page of REAPER's preferences can be used to specify record configuration defaults for future tracks and projects, including turning input monitoring off and selecting default inputs – see [Chapter 22](#).

Tip: When recording, make sure that the incoming signal is not too loud, or you can damage your recording equipment. Here's what to do:

1. Turn the input or gain control on your input device (e.g. firewire device or desk) all the way **down**.
2. If recording an instrument in-line, insert one end of the line into the instrument and the other end into your input device. Turn the output on the instrument fully **up**
3. Audition the instrument, slowly raising the input or gain control on your input device until it sounds right.

3.6 To Prepare and Record Multiple Tracks

To prepare multiple tracks for recording you could repeat all of the necessary steps as many times as you require tracks, but that might be tedious – and besides, it's too easy to make a mistake when selecting your audio inputs. You could end up with one input being recorded more than once, and perhaps another input being accidentally missed out. To avoid this problem, you can follow this sequence:

1. Use the **Insert, Multiple tracks** command to insert as many tracks as you require. The **Insert tracks** dialog will be displayed. Select the number of tracks required and choose to insert them **After the last touched track** or **At end of project**. Click on **OK**. Name your new tracks.
2. Select all tracks to be recorded. After making your selection, click on the **Record Arm** button of any one of them to arm the entire selection.
3. One method is to use the **Routing Matrix (Alt R)**. Click in the appropriate cells in the Routing Matrix to assign each track to a different input.
The example shown uses audio inputs - Input 1 is to go to Track 1, Input 2 to Track 2 and so on. MIDI inputs may also be selected – these are listed below the audio inputs. You can also right click over any red cell to access the Record Input menu should you wish to do so.
4. Monitor the strength of the signals and record as before.

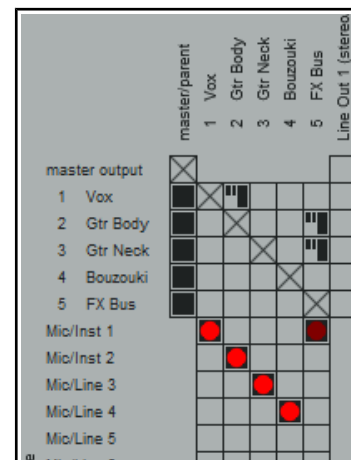

Another option is to use the TCP to set up and record your tracks:

Recording Audio and MIDI

1. To define the same record settings for multiple tracks, select the tracks, right-click on the arm record button, then make your choices from the menu. Holding **Shift** will over-ride this and apply your menu choices to the one track only. Inputs can be assigned to a selection of tracks in a similar way by clicking on the **Input** button.
2. To assign a series of mono inputs in sequence to a set of tracks, select the tracks then click the **Input** button of any track in the selection. Next, select **Assign inputs sequentially** then your required inputs – e.g. in the above example, this would be **Mono, Input 1 to Input 4**.
3. To insert a new track at the end of your project, you can simply double click in the Track Control Panel area, just below the last existing track.

3.7 Auto Arming Tracks

You can ensure that tracks are automatically armed for recording when selected and unarmed when deselected. Select the track(s) then right click over the record arm button for any selected track and choose **Automatic record arm when track selected**. This command can be toggled on and off.

The main menu **Track** command includes an option **Set all tracks to automatic record arm when selected**.

3.8 Using the Metronome

You can set up and use a metronome when using REAPER for recording. Use the **Options, Metronome enabled** command to turn it on and off (or left-click the metronome button on the toolbar), and the **Options, Metronome/ pre-roll settings** command to set up your metronome (or right-click on the metronome button on the toolbar).

The Metronome Settings

Enable metronome: This turns the built-in metronome on or off.

The Output Button: To the immediate right of *Enable Metronome*, this allows metronome output to be sent to the device of your choice. If your headphones are connected to (say) Outputs 7/8 then you would probably wish to choose these as your outputs.

Run during playback: This will turn the metronome on during playback.

Run during recording: This will turn the metronome on during recording.

Count-in before playback : This will enable a count-in before playback.

Count-in before recording: This will enable a count-in before recording. Useful if you are recording yourself. It ensures that when you press **Ctrl R** the recording will not actually start until after the specified count-in. This gives you time to get back to the microphone and pick up your instrument.

Count-in measures: This defines the number of measures a count in should be. If it is the very beginning of a project, it will wait those number of measures before starting to record. If you select a place to record within a project, it will start the count in this many measures before the time that you want to record at. Optionally you can choose to **Start count-in at start of measure**.

The number of cells in the **click grid** will be determined by the time signature: that shown here represents a 4/4 time signature: a time signature of 3/4,, for example, would display a grid of three columns and four rows.

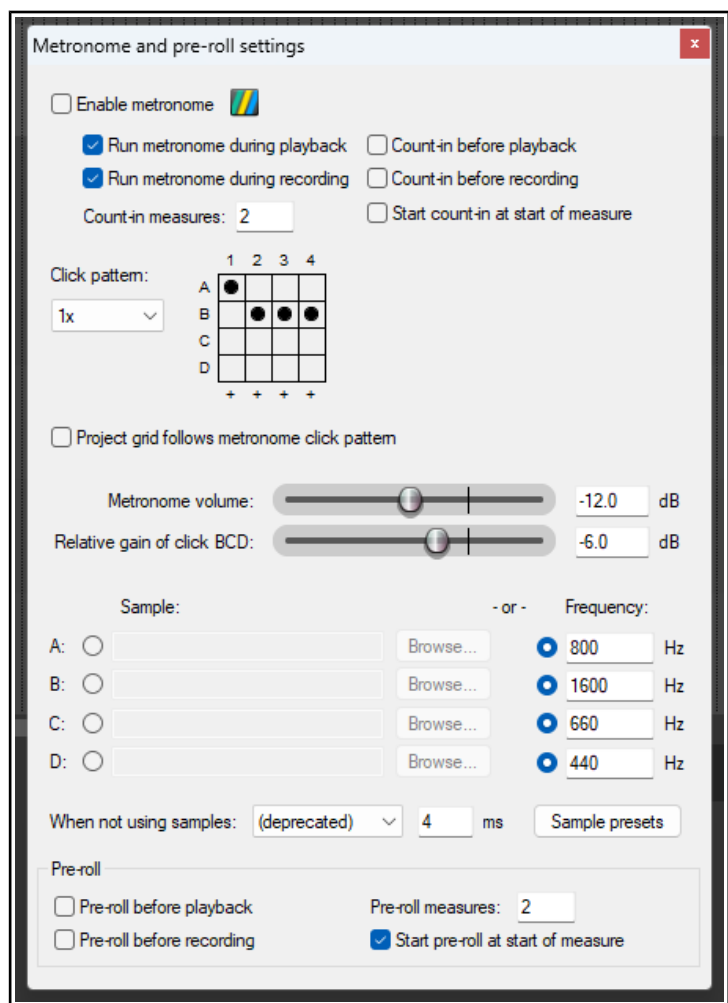

Up and Running: A REAPER User Guide v 7.31

By default the **click pattern** is set at 1x: if you change this to 2x the number of columns in the grid will be doubled, as will the click speed. Notice also an option **Project grid follows click pattern**.

The two horizontal faders adjust the **metronome volume** and the **relative gain of clicks BCD** respectively. Let's now consider what those black dots represent.

You can load up to four sound files into the metronome. In the example shown, we have used just two. Any option that is left blank (in this example C and D) would use a default metronome sound at whatever frequency you select. In the example shown above, sound A would be played for each first click, sound B for clicks two, three and four.

You can select how the sound is to be shaped **when not using samples**: select from the drop-down list – sine, triangle square or sine+square. There is also a button to **Reset** frequencies to their default.

The **Pre-roll** settings can be used so that when you start recording, or playback, the metronome will play for the specified number of measures before recording or playback actually begins.

You can also save, recall, rename and/or delete **sample presets** of your metronome settings. Options here include **Use project metronome samples/frequencies**.

Recording during audio pre-roll

To record audio during audio pre-roll, the **Audio, Recording preference to record audio during pre-roll** option will need to be enabled.

Then, **Enable metronome** and the metronome settings options **Run metronome during recording** and **Pre-roll before recording**. After the recording is finished, drag the left edge of the recorded item to the left to reveal what has been recorded.

Note that some metro settings can be changed within the **Tempo/Time Signature Marker** window which is displayed when you **Insert Tempo/Time signature marker** on the timeline.

Tip: The default Metronome Time Base is determined by the **Project Settings**. Press **Alt Enter** and display the **Project Settings** page if you need to change this.

3.9 Recording Stereo Tracks

You can record from two inputs direct to a stereo track, for example, if you are recording stereo paired microphones. Follow a similar procedure to that explained in section 3.5, selecting a stereo input instead of mono. The signal from paired stereo inputs can be recorded on to a single stereo item on a single track.

As has already explained in [Chapter 2](#), it is advisable to open the Audio page of your Preferences settings and turn off the option to **Show Non-Standard Stereo Channel Pairs**. This will reduce your available stereo paired inputs to a more logical selection such as that shown above.

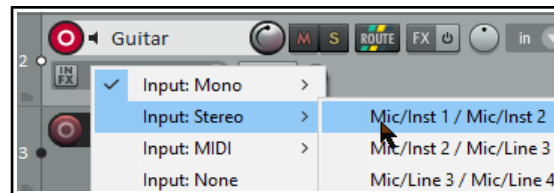

3.10 Multi-Channel Recording

If in its routing window you define a track as multichannel (for example, perhaps 4, 6 or 8 channels) then your recording input context menu for that track will include an option for multichannel recording. You can, for example, record from four, six or eight microphones simultaneously, each to a separate channel on the one track. Up to a maximum of 128.

This method is suited, for example, for use with four channel ambisonic microphone arrays as used in surround sound production.

For multichannel tracks, there is also a toggle command on the record arm context menu **Meters, Multichannel peaks**. This should be automatically enabled..

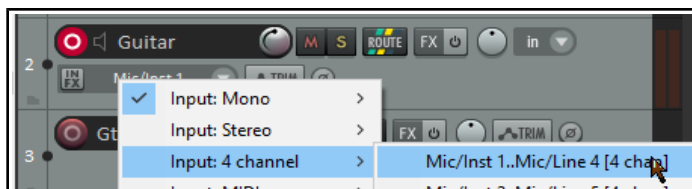
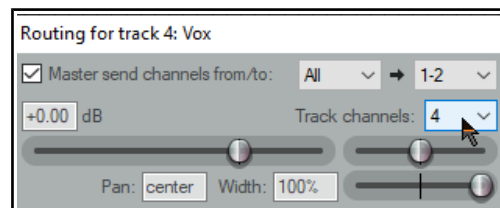

Recording Audio and MIDI

3.11 Track Templates

After you have set up a track (or a number of tracks) for recording, you might think that you may wish to use this same track exactly as it is again in some future projects. This can be done using **Track Templates**.

To create a track template from an existing track (or selection of tracks):

1. Select the track or tracks.
2. Choose the **Track, Save tracks as track template** command.
3. When prompted, type a template name. If you wish, you can select the option to **Include track items in the template**. If so, any audio and MIDI items on the track will be included. You may also choose to **Include envelopes in template**. ([Envelopes](#) will be explained in Chapter 18).
4. Click on **Save**.

To import an existing track template into a project:

1. From the REAPER menu, choose the **Track, Insert track from template** command.
2. Depending on how your templates are stored, either select the required template from the menu, or choose **Open template**, then choose the required template and click on **Open**.

The **Insert track from template** sub-menu includes **Offset template items by edit cursor**. If enabled, any media items and/or envelopes saved with the original template will be inserted at the edit cursor position.

Note: Track properties and settings are saved into the template, including track name, inputs and outputs, any FX plug-ins (with any parameter settings, parameter modulation, and track controls), sends and receives. However, if a track included in a track template includes any sends to or receives from any track or tracks not included in the template, then these sends and receives will not be saved into the track template.

Tip: Organizing track templates. You can find where your track templates are stored by using the **Options, Show REAPER resource path ...** command (see Chapter 1). Here you can create subdirectories within the TrackTemplates folder where you to store and arrange your track templates as you please. Your subdirectories and their contents will automatically be shown on the **Insert track from template** sub menu.

3.12 Importing an Existing Project

The **Track, Insert track from template, Open template** command will import an entire REAPER project into your current project. All aspects of the tracks are imported – media items, track settings, FX, routing, etc.

However, items that are not track specific (such as markers) are not imported.

To do this, select **Project Files** as the File Type when

the **Open Track Template** dialog box is displayed, navigate to select the file you wish to import, then click on **Open**. The tracks from the imported project file are inserted immediately below the currently selected tracks.

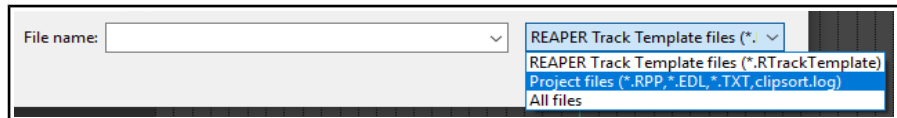

3.13 Project Templates

A project template goes further than a track template: it can be used to create an entire project file, based upon the structure and settings of the template file. For example, tracks and their parameters (name, color, pan setting, FX chain etc.), project settings (including media settings) are saved with a project template, along with the screen layout, which views are open, how they are sized, whether they are docked, and so on. Delete unwanted media items from a file *before* saving it as a project template, otherwise every time the template is used to create a new file, these will be inserted.

To create a Project Template:

- With the source project file open, choose the **File, Project Templates, Save As Project Template** command. When prompted, give the template a name, then click on **Save**.

To create a new file based on a Project Template

- Choose the **File, Project Templates** command, then click on the name of the required project template.

To use an existing file as a template for all new projects:

- Choose the **Options, Preferences** command, then **Project**.
- Click on the **Browse** button labeled "When creating new projects, use the following file as a template".
- The contents of the project templates folder will be displayed.

Up and Running: A REAPER User Guide v 7.31

- Select the required file, then click on **Open**.
- Click on **OK** to close the Preferences window.

3.14 Layered Recording

The term *layering* refers to a recording technique in which two or more instruments and/or voices are recorded for the same song, but not all at once. The tracks can be recorded one at a time. An initial track is laid down – this is often a guide track which will be discarded at the end of the recording process. Then each other track is recorded while the musician or singer listens thru headphones to a mix of what has already been recorded and what she is recording now. In order to use this layered recording method:

1. With Record Mode set to **Normal**, record the initial track, as explained earlier.
2. After recording, make sure the output of this track is directed to the Master. *Make sure also that you "disarm" this track.*
3. Make sure that the Master is directed to whichever hardware outputs are connected to your headphones or headphone amp.
4. Add another track. Name it. Arm this track for recording. Select the Input used by the microphone or line that is to be used to record this new track.
5. Make sure that **Record: input (audio or MIDI)** is selected and (if your soundcard does not support direct monitoring) that **Input Monitoring** is turned on for this track (see above). This will enable the person being recorded and the recording engineer to hear in their headphones a mix of previously recorded material with that being recorded now.
6. Adjust the Volume levels of the previously recorded track (using the track fader) and the volume level of the incoming signal (using your external mixer desk or audio device, or audio device control software) until you are happy with your headphone mix.
7. Press **Ctrl R** to start recording, and **Ctrl R** again to stop when finished. Again, disarm this track when you have finished recording on it.
8. Repeat this procedure for all other tracks to be layered. At step 6. you can feed into your Master a mix of all tracks previously recorded up to that point.

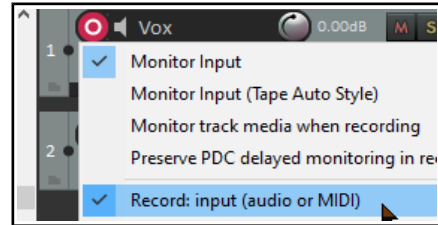

Note: If you notice an echo type delay in your headphones it will be because latency is too high. Lowering the block size (see 1.12) to 256 or 128 can improve this. On consumer quality built in sound cards, however, this might cause pops and clicks. For Windows users, the use of ASIO drivers might help resolve this.

Tip: Many sound cards and USB or Firewire audio devices come with software that can be used for zero latency input monitoring and headphone mixing, especially those devices with multiple inputs and outputs. If you use that software for input monitoring, then you should turn off the input monitoring option within REAPER.

Try it now! Open the supplied project file **All Through The Night.RPP** and save it as **All Through The Night LAYERS.RPP**. Have a go at recording another instrumental track of your choice to go into this project - any instrument you choose!

Note 1: Monitor Input (Tape Auto Style). This option differs from normal input monitoring in that it monitors input only when the transport has stopped or when you are recording. During playback you will hear only the timeline audio, not the input.

Note 2: If you are monitoring an armed track when an existing track uses a plug-in (such as ReaFir) that has latency, you may wish to consider enabling the option **Preserve PDC delayed monitoring in recorded items**. This more advanced topic will be explained in more detail later in this chapter.

3.15 Overdubbing and Punch Recording

You can go over an existing track to re-record sections with which you are not satisfied, to correct perhaps just a few notes of an instrument, or a line or two of a vocal. Use punch recording for this. You can play back in your headphones previously recorded material along with any other tracks while you record. At the point where you want recording to begin, the track on which you are recording will cut out, and the recording will begin. At another point specified by you, the recording will stop, and the existing recording will come back in.

The technique can be applied with both audio and MIDI items. [MIDI is discussed later in this chapter](#) when [looped time selection recording](#) is also explained.

Recording Audio and MIDI

Note: This technique involves creating more than one **take** for a track, and then comping the required output from whichever takes you prefer. REAPER makes available two ways you can do this – traditional takes and media item lanes. The former is less complex: the latter is more powerful and offers more options. Throughout this chapter we will focus on the **takes** method: media item lanes will be covered in a later chapter.

3.16 Non-Destructive Punch Recording

By default, punch recording is not destructive: it creates a new take, but does not destroy the original. To use punch recording, follow this sequence:

1. From the **Options** menu choose **Record mode: time selection auto punch**. Set **New recording that overlaps existing material to Split existing items and add takes (default)**. All other options on this submenu should be turned off. Disable toggle repeat on the transport toolbar.
2. Select the track and arm it for recording. Right click on the track panel to open the context menu: make sure that both **Fixed item lanes** or **Free item positioning** are both turned off.
3. View the **Options** menu and for now ensure that **Show all takes (when room)** is *not* selected. We'll look at this shortly. Also, for this example, make sure that **Loop points linked to time selection** is **not** enabled.
4. Make sure that the track output is sent to the Master and (if not using direct monitoring) that Input Monitoring is enabled.
5. Make sure that the Master output is directed to the audio hardware outputs to which your headphones are connected.
6. Click once on the existing media item to select it. Click and drag along the arrange background area to select the region that you want to be re-recorded (see above).
7. Press **Home** or **W** to rewind the track to the start of the track. Press **Esc** to clear the time selection.
8. Press **Ctrl R**. You will hear the recorded material up to the start of the defined region, where you can re-record that passage. Press **Space** to stop when you have finished recording. Accept the option to save your recorded media. Restore normal recording mode when you have finished punch recording.



Your track now contains two media items. What's happened to the originally recorded passage? Well, it's still there and you can still use it if you like. Pressing **Ctrl L** toggles the display of all takes or active take only (see above). We'll learn more about this soon.

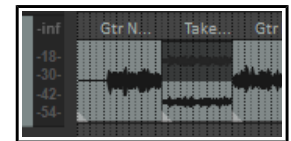
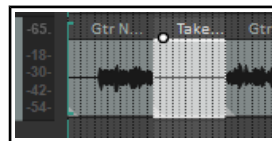

What if you prefer to use the original recording after all? In that case, simply click on it to select it.

Non-destructive punch recording with pre-roll

The **metronome** can be used to engage pre-roll before recording starts. This help you to know exactly when to come in when punch recording.

Enable the metronome on your toolbar, then right click over the metronome button to access its settings.

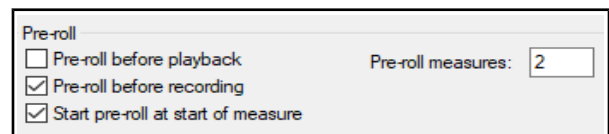

Enable **Pre-roll before recording** and (preferably) **Start pre-roll at start of measure**. You should also specify the **number of measures** through which you want the pre-roll to play: the default is two.

Note: The record button context menu includes the option **Monitor track media when recording**. If you enable this when punching in, say, a guitar or vocals, regular **Monitor Input** will cause you to hear both the existing and the new material right up to the punch, and during the punch. **Monitor Input (tape auto style)** will monitor only the existing materials up to the punch, but both existing and new during the punch.

Tip: If you make a mistake or change your mind when overdubbing, you can use **Ctrl Z** to undo the recording or you can select the unwanted media item and use the **Delete** key to remove it.

Getting to grips with REAPER's various record modes and in particular how they work in combination with other options (such as monitoring) can be somewhat bewildering for new users. An Appendix includes a summary table [Troubleshooting Record Modes and Monitoring](#).

3.17 Destructive Punch Recording

You have the option when punch recording of actually removing from the existing track the previously recorded material if you wish. If this is what you want, use the **Options, Overlapping recording behavior** command on REAPER's main menu to turn on the toggle option **Trims existing items (tape mode)**. Be careful how you use this. You can restore this option to its default setting by choosing **Splits existing items and creates new takes** from the same menu.

This menu also allows non-destructive options to **Add lanes (all lanes play)** or **Add media items in layers**.

3.18 Fades and Crossfades

REAPER allows you to apply automatic crossfades and fades in and out of your recorded items. This feature can be turned on and off or customized thru the [Options, Preferences, Project, Item Fade Defaults](#).

You can select a preferred shape and duration (length) for your fade curves. Clicking on the image of the curve (shown above)

opens up a number of choices (see right). You can easily change the default fade type and/or length for individual media items (see [Chapter 7](#)). There is also an option for overlapping recorded media items whether to apply crossfades to the left, right or center.

There are also numerous actions available in the [actions list](#) relating to the use and management of fades and crossfades.

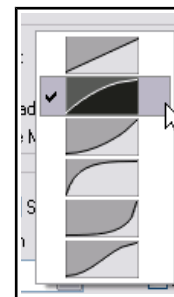
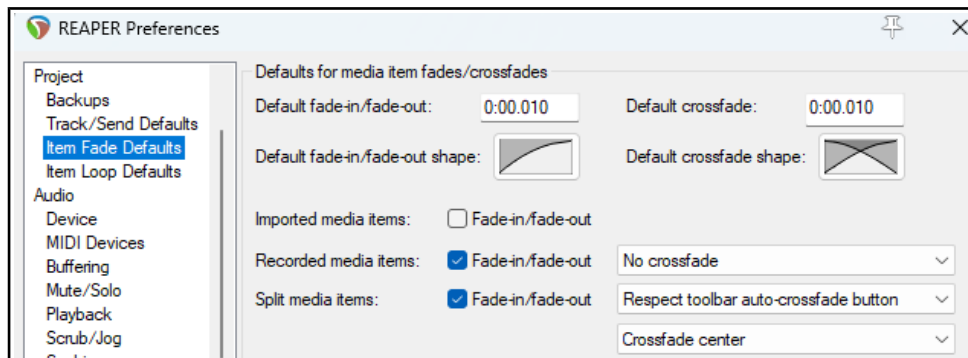

3.19 Recording Multiple Takes

REAPER's multiple takes feature can help you when you want to record several versions of a track to see which you prefer. It works like this:

1. Set record mode to normal (**Options, Record Mode: Normal**).
2. Set **Options, Overlapping recording behavior** to **Split existing items and add takes**.
3. Make sure that on the **Options, Overlapping recording behavior** menu both of the **Add lanes** options are **off**.
4. Use the TCP right click context menu to make sure that both **Free item positioning (FIPM)** and **Fixed item lanes** are *not* enabled (i.e., not ticked) for the tracks being recorded (see **Note 2** below)
5. Record your first take of the track.
6. Rewind to the start then record your next take.

In the example shown, an initial vocal track has been recorded, then above it three takes have been made of a vocal harmony track.

Notice the text displayed with the name of the media item displayed for the Harmony Vox track. It begins with the text **Take 3/3**.



Note1: Under [Options, Preferences, Appearance, Peaks/Waveforms](#) there is a setting to **Automatically color any recording pass that adds new takes to existing items**. When you are recording multiple takes to two or more tracks, enabling this option can help you to visually identify which takes belong in the same set.

Note2: Before recording multiple takes in this way, you can go to **Options, Preferences, Project, Track/Send Defaults** and make sure that both Free item positioning and Fixed Item Lanes are not enabled.

Recording Audio and MIDI

3.20 Displaying Multiple Takes

Optionally, when you have multiple takes, you may choose to have them all displayed together. This of course takes up more room on the screen, but has the advantage that it makes it easier to see for your various tracks which take is currently selected. This option is toggled on and off by pressing **Ctrl L** or by choosing **Options, Show all takes (when room)** from the Main Menu.

In the first example (shown right), three takes have been made of a vocal. The first and third are complete takes, the second is a punched-in overdub of only the middle section.

In this case, the option to **Display empty takes (Options, Take behavior menu)** has been enabled. This ensures that the short overdubbed section is given its own distinct space. This makes it easier for you to keep track visually of which parts of each take belong together.

In order to be able to choose the best parts from each take, we have split

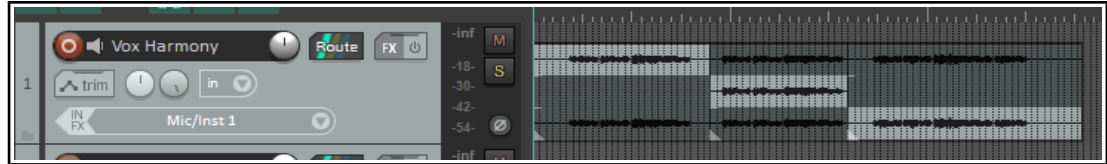

the media items. To do this, select the track, position the cursor at the required spot and press **S**.

We can then make our selection as shown above.

In this second illustration, we press **Ctrl L** to turn display of lanes off.

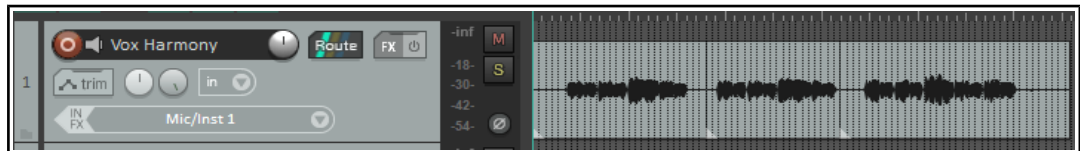

Only those segments that we have selected can now be seen.

Note: When you create multiple alternative takes in this way you will later be able to easily pick the best passages from each of your takes and join them together as a single item. The method for doing this will be explained in [Chapter 8](#) of this User Guide.

3.21 Using Color Coded Takes

REAPER's **Item, Item and take colors** command (REAPER main menu) offers a variety of interesting ways that you can use color when working with takes and items (see right). We'll look at this whole topic in detail in [Chapter 7](#), but for now notice the command **Set active takes to one random color**. Double-click in track panel to select the entire media item before giving this command.

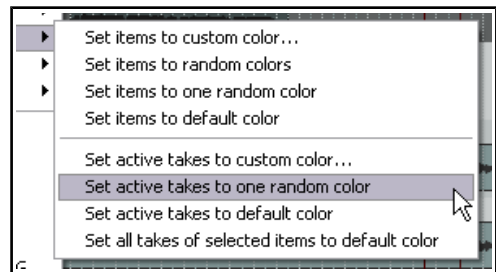

If after making your preferred working selection of takes for any track you double-click on that track in the Track Control Panel then all media items in that track will be selected.

Choosing **Set active take to one random color** will now produce an effect similar to that shown below.

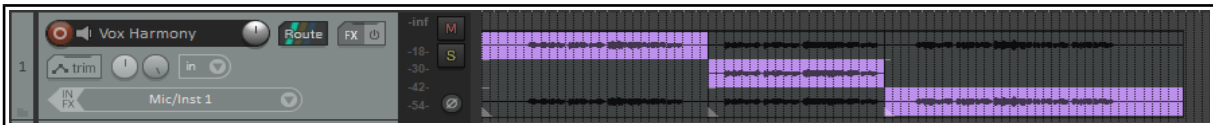

The section that follows, along with most subsequent sections in this chapter, uses images that show an earlier default color theme.

However, you should have no difficulty applying the instructions using the REAPER 7 default theme, or any other theme of your choice.

3.22 Working With Multiple Takes

Where an item includes more than one take, you can right click over any take and use the **Take** command to control and manage your multiple takes. The Take submenu is quite extensive - we'll explore most of its features in [Chapter 8](#). For the time being, however, you should be aware of the following, especially if your takes are not displayed in lanes.

Command	Shortcut	Effect
Next Take	T	Displays next take for selected track(s).
Previous Take	Shift T	Displays previous take for selected track(s).
Explode All Takes to New Tracks		Creates a separate track for each take (see below).

Explode All Takes to New Tracks differs from **Show All Takes** in that it lets you treat each take separately as a separate track. The picture on the right illustrates this.



Track 1 consists of two takes which are shown in lanes. After exploding these takes to new tracks we have (in addition to the original track) two new additional tracks, one for each take.

Caution: One look at the **Take** submenu (on the media item's right-click context menu) will show you that there are commands available for deleting takes and cropping to active take. You are advised to avoid these until you have worked thru Chapter 8 of this guide. In particular, avoid using the **Delete** key when selecting takes: you are likely to delete more than just the take that you don't want!

Try it now! Open the project file **All Through The Night LAYERS.RPP** (which you saved earlier) and add a vocal harmony track to this project. Use this track to record three takes – then save the file.

3.23 Overlapping Items

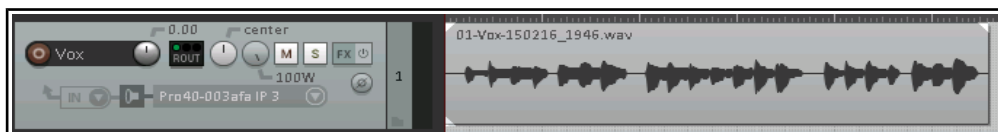

You have already been shown two of the three overdubbing options on the

Options menu command **New recording that overlaps with existing media**, i.e. **Split existing items and add takes (default)** and **Trim existing items (tape mode)**. A third option is to **Add lanes (layer new lanes)**.



This example shows this. In the first illustration (top) a part of a track has been recorded. In the second illustration (above), we have returned to this track and with the option **Add lanes (layer new lanes)** enabled we have re-recorded the last part again, together with some new material.

In this case, the second take is to all intents and purposes a separate media item. You can choose which of these media items are and are not played.

There is also an **Options** menu command to **Offset overlapping media items vertically**. This will display overlapping items one above the other, provided, of course, there is sufficient track height to do so.

This general topic will be addressed again later in this guide, especially throughout Chapters 4, 5 and 7.

Recording Audio and MIDI

3.24 Recording Multiple Additional Items

We have seen how to use REAPER to record multiple takes on the same tracks. Later, [Chapter 8](#) explains how to organise and edit these, taking the best parts from various takes and patching them together into a single take. Instead of using multiple takes, however, you may wish to record new items onto an existing track, perhaps overlapping. This is one case where free item positioning gives you greater flexibility. By default, free item positioning is disabled. To record extra items (rather than takes) on to an existing track, follow this sequence:

1. Set record mode to normal (**Options, Record Mode: Normal**).
2. Turn on **Free Item Positioning (FIPM)** for the track being recorded. Right click on the track's Track Control Panel and select **Free item positioning** if this is not already ticked.
3. Record your first item for the track.-
4. Position the cursor at the point where you wish to record the second item. Record this item.
5. Repeat step 4. as often as required.



Example

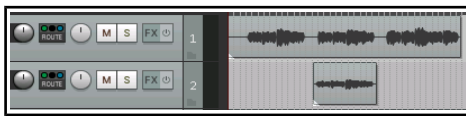

In the first screen shot here, Track 1 contains a Vocal Track and Track 2 a Vocal Harmony for part of the song.



In the second, the option for **Free item positioning (FIPM)** has been enabled for Track 2. The mouse cursor shows a small handle that can be used to adjust the height of this media item.

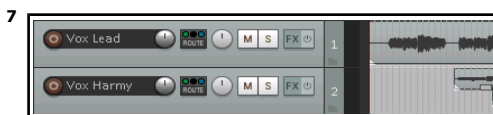

In the third screen shot, a second Vocal Harmony has been recorded on to Track 2, overlapping the original harmony.

Notice that this is not an alternative take of the first harmony, but an *additional* media item.

Note 1: Enabling **Offset overlapping media items vertically (Options menu)** will ensure that overlapping items are shown this way, whether editing or recording.

Note 2: **Options, Preferences, Project, Track/Sends Defaults** includes an option to make free item positioning enabled for your tracks by default.

Note 3: **Options, Preferences, Project, Item Fade Defaults** includes an option whether or not to crossfade overlapping recorded items.

3.25 Recording with Empty Events

This section, along with most subsequent sections in this chapter, uses images showing the **REAPER 5** default color theme. If you wish to use this theme, choose Options, Themes, Default_5 from the main menu. Otherwise, you should have no difficulty applying the instructions using the REAPER 6 default theme.

Empty events are a device which can be helpful when you are overdubbing or layering. If you know exactly the regions where you want recording to start and stop, you can define these regions by inserting empty events. Then, when recording is commenced, only those regions defined by the empty events will actually be recorded. Let's take an example where a vocal track has already been recorded, and we want to lay down a harmony vocal, where this harmony is only used for the chorus line of the song. This is how you would do this:

1. Insert a new track to be used for the vocal harmony. Ideally, you should name this track straight away.
2. Arm the track for recording. Assign an audio input in the usual way. Turn on **Monitor Input** for this track, and make sure the output from the Master is directed to your headphones.
3. Use the **Options** menu to ensure that **Record mode: auto punch selected items** is chosen. Notice the appearance of the Record button in the transport bar changes.
4. To create an empty item, first make sure that your new track is selected. Click and drag to define a time selection, then use the **Insert, Empty item** command to create the empty item. Repeat this as often as required. If necessary, click and drag to adjust their exact positions. An example is shown here.

5. If you need to resize any of them, hover the mouse over the border between the end of the event and the background, about half way up. Click hold and drag to the left to make it shorter, or to the right to make it longer, then release the mouse.
6. To select all the required events, hold the **Ctrl** key while clicking on each in turn. If you need to reposition the play cursor before recording, click on the Timeline. Arm the track for recording.
7. Press **Ctrl R** to start recording. When finished, press **Ctrl R** again to stop. If prompted, accept the option to save all files. Your previously empty media items will have been replaced with your newly recorded material. Disarm the track.

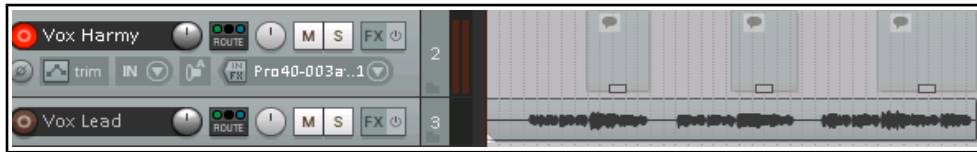

3.26 Recording with Input FX Plug-ins

Audio effects (FX) are usually added to a track later in the production process, after the material has been recorded. This subject was introduced in [Chapter 2](#), and you'll find more about it elsewhere (for example, in [Chapter 16](#)). You are also able to apply plug-ins to material as it is being recorded. Use this facility with caution, as once an effect has been added in this way it effectively cannot be easily reversed (if at all). This technique is sometimes used, for example, when experimenting with different FX. The procedure is as follows:

1. Arm the track for recording and select the required audio or MIDI input device in the usual way.
2. Right-click on the Record Arm button and choose **Track input FX chain** from the context menu. This causes the **Add FX to Track** window to be displayed.
3. Select any effect required, then click on **Add**. Set the parameters for this effect.
4. Use the **Add** button to add any additional effects.
5. Close the FX window.
6. Audition the performance and the effects as necessary, then record the track in the usual way.

Effects placed in a track's input FX chain only use resources when the track is armed, and are applied destructively to the media item during recording. Most probably, before doing this you will want to audition the instrument or voice being recorded together with these FX so that you can get the parameter settings right. To do this, you simply need to keep the track armed and turn on input monitoring while you listen to the live material and adjust the FX parameters to suit. Input monitoring is explained elsewhere in this guide, for example in the sections dealing with layered and overdub recording.

3.27 Input Monitoring without Recording

You might wish to monitor an incoming signal (perhaps with input FX enabled) to ensure that you have the sound exactly as you want it before actually recording anything. Set up the track input in the normal way; then follow this sequence:

1. Click on the track's **Record arm** button.
2. Right-click on this button.
3. From the context menu, choose **Record disable (input monitoring only)**.

From this point, proceed as if you were actually recording. You will hear exactly what would have been recorded.

3.28 Preserve PDC Delayed Monitoring in Recorded Items

When monitoring audio on an armed track against previously recorded tracks any of which uses a plug-in that has latency (such as, ReaFir) this will cause the output to be delayed. In this case you may wish to have the recorded output sound exactly as you are hearing it while recording. For example, you might be playing the notes early to make it sound right.

With this option on, it will play back the same way you heard it as you played it, with the option off it will be earlier (as the PDC of the plug-in will take effect). In the recorded clip, the PDC amount is indicated by two small right-angled triangular indents.

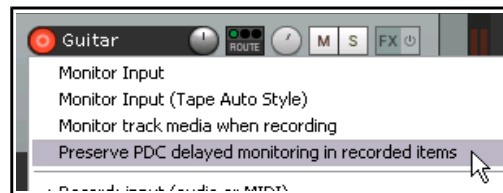

Recording Audio and MIDI

3.29 Recording a Track's Output

There are a number of reasons why you might wish to record a track's audio output. One example might be to record the output from an external synthesizer directly onto an audio track. Another might be to record the output generated by a receive from another track.. Here is an example of how you might do this:

1. If recording from an external synth, connect the MIDI keyboard to your PC. Make sure it is enabled in your MIDI device preferences.
2. Create a new track. Name it and arm it for recording. Enable input monitoring.
3. From the record arm context menu select **Record: output** then your required channel options. Most often this is likely to be mono, latency compensated, but options are also available for stereo and multichannel, with or without latency compensation.
4. From the same menu select your required output mode. Available options are post fader (the default), post-fx/pre-fader or pre fx.
5. If recording from an external synth, select **Input: MIDI**, then select your input device from the menu .
6. Make such adjustments as you might need (e.g. to the synth parameters) while you audition the music.
7. When ready, record.
8. Stop recording when finished.

3.30 Recording FX Bus Output

You can record the output of an FX bus track. For example, you could record the output of a reverb bus to a stereo audio track, then use stereo or dual panning to adjust its positioning in your mix. Here's how:

1. Set up a **FX Bus** track, select it, and arm it for recording.
2. You might wish to also turn up the track's **Receives** to get a good strong signal – you can always turn down the volume when playing it back later.
3. On the record arm context menu, set the track to **Monitor Input** and chose a **Recording Mode**. This is likely to be **Output, Stereo**. Output mode will most likely want to be **Post fader**.
4. Play the song and monitor the signal level.
5. Rewind to start and press Record. Stop recording when finished.

Tip: After doing this you will most likely want to mute the sends to the bus and set the bus FX to bypass. It can still be a good idea to leave the FX inserted in the bus, as a record of how the output was produced.

3.31 Recording MIDI

You have a number of options for recording MIDI, depending on what equipment you have and how it is set up. In every case, however, the principle is the same:

- You will need to use either REAPER's virtual keyboard or a MIDI input device, such as a keyboard attached via a MIDI In port on your sound card or other audio device.
- You will need to create a track (or assign an existing one) for your MIDI recording.
- You will need to assign an output device for your track.
- You will need to assign a Channel for the MIDI item.
- You will need to turn Input Monitoring on to be able to hear what you are playing.

REAPER's Virtual MIDI

Keyboard, can be played using your mouse or PC keyboard. This keyboard is displayed using the command **View, Virtual MIDI Keyboard**. The shortcut keys **Alt B** can be used to toggle display on and off.

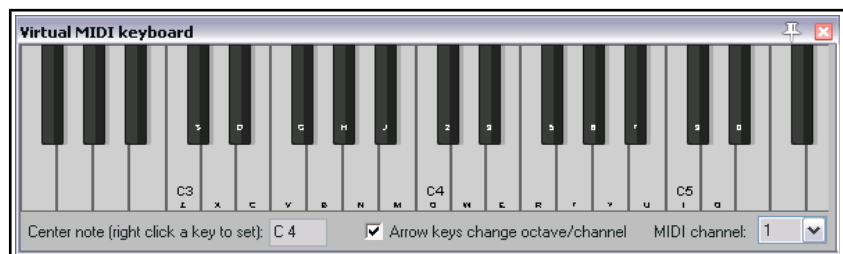

MIDI Ports: MIDI architecture

imposes a limit of 16 channels per device. However, you can use a MIDI patch bay to work round this restriction by allowing multiple devices to be connected. REAPER allows up to 62 MIDI ports for input and 64 for output. Virtual MIDI ports can be defined and used via software such as MIDI Yoke or loopMIDI.

Procedure for Recording to a new MIDI Track

1. Insert a new track into a project file. Arm this track for recording.
2. Ensure that your MIDI keyboard is connected to the computer, MIDI Input of your sound card or Audio Device and that it is switched on. In this example, we will use the **REAPER Virtual MIDI Keyboard**. If this is not visible, press **Alt B**. Right click over any key that you wish to be your centre note.
3. Right click on the track's arm record button (as shown). Make sure that **Monitor Input** and **Record Input** are both selected: choose the **Virtual MIDI Keyboard** as the **Input: MIDI** device. For this example, select **All Channels**).
4. Make sure the Track's output goes to the Master, and that the Master output goes to the hardware audio outputs connected to your speakers or headphones.
5. Open the **FX** Window for this track. You will need to insert a Software Synthesizer here. You can use any such VSTi or DXi synth that you already have installed. In this example, we will be using **VSTi ReaSynth (Cockos)**, which is included with REAPER. For the time being, leave the ReaSynth parameters at their default settings.
6. Press **Ctrl R** to start recording. Play a simple tune on the Virtual Keyboard. Use your mouse or PC Keyboard – e.g., **zxcvbcxz** will play half a scale up and down. When finished. Press **Ctrl R** again to stop recording. If prompted, save your media item.

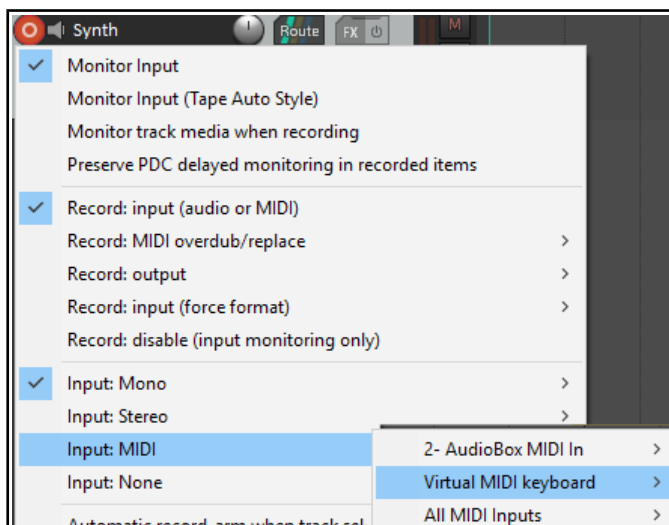

See also [Recording MIDI from keyboard checklist](#) later in this chapter.

In Chapter 13 we will see how your MIDI data can be edited using REAPER's built in [midi editor](#).

Procedure for Playing Back a MIDI Item

Play the track. As it plays, you can alter the nature and shape of the sound by adjusting the soft synth parameters. When you have found a sound you like, you can click on the + button in the FX Window (indicated by the mouse cursor, shown left) and then choose **Save Preset** to name and save that set of parameters. Your named preset can be recalled from the Preset drop down list any time. You can make and use presets in this

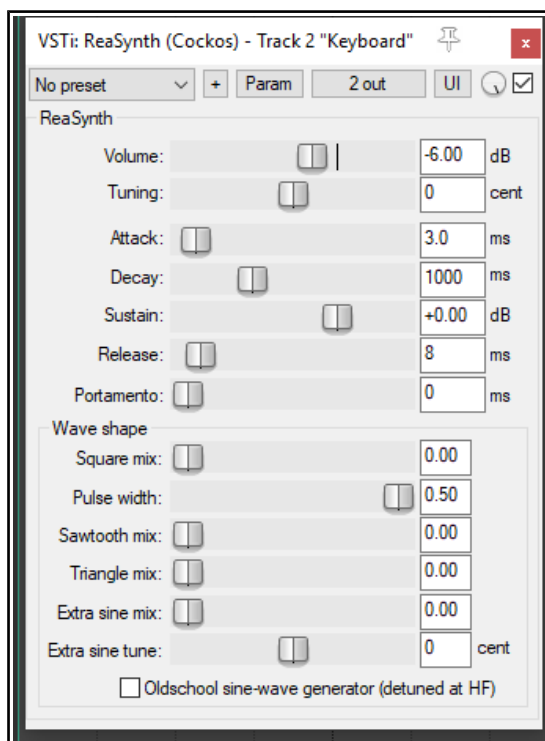
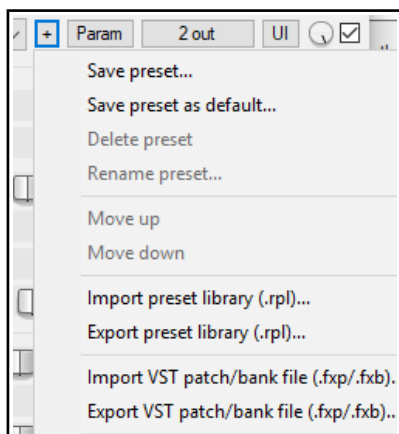

way for all FX Plug-ins and Synths. With VSTi synths, you are also able to import and export patch/bank files (see above).

For more information including troubleshooting, see the section [Recording Thru MIDI Channels](#).

Recording Audio and MIDI

Note: The example above demonstrates an important difference between MIDI and Audio. With **Audio** the actual sounds made by the instrument or voice are recorded. It is possible to use FX like EQ and Compression to alter how the audio item sounds when played back, but the audio item itself stays the same.

With **MIDI**, you are essentially recording a series of instructions that by themselves have no sound. The music is created when those instructions are fed to a synthesizer. By changing the parameters of the synthesizer's settings – or even by changing the synthesizer – we are able to produce a completely different sound.

Despite these differences, both audio and MIDI items can be included on the same track.

Note: Before recording, you can assign sequential input channels to a number of MIDI tracks in one action. Select the tracks, then click on the **Input** button for any one of them. From the menu, choose first **Assign inputs sequentially**, then **MIDI (sequential inputs or channels)**, then select the MIDI device, then the channel selection (e.g. for four tracks, perhaps channels 1 to 4).

3.32 Other MIDI Recording Modes

When recording MIDI, you should select one of six modes. In the above example, we used **Record Input**. With this mode, any existing events will be retained: the new material will be recorded as a new take.

Four of the other five are **Record: MIDI overdub replace** modes (in project MIDI items only):

- **Record MIDI overdub:** adds new notes on any channel **within** existing items, preserving what is already there.
- **Record MIDI replace :** from the time you start recording until you stop, existing MIDI notes will be removed and any new material played on any channel will be recorded in their place.
- **Record MIDI touch-replace:** existing MIDI notes will be replaced by any new notes played over them on the same channel as the original material. All other existing material will remain as it is.
- **Record MIDI latch-replace:** existing MIDI material remains unchanged until you strike the first note. All of the old material will then be replaced with notes played on the same channel as the original material until recording is stopped.
- **Record Output -> Record: output (MIDI):** Similar to the input mode, but records the MIDI signal coming out of the FX chain.

Note that these options can often be used effectively with time selection recording (see sections 3.16 to 3.18) and looped time selection recording (see below).

3.33 Recording With a Virtual Instrument

To use a virtual instrument (such as a VSTi or DXi plug-in) for recording a MIDI track, you can use the main menu **Insert, Insert virtual instrument on new track...** command. You will then be presented with a selection of all the virtual instruments that you have installed on your system. Double-click on the required item. The track will be created, armed and named and the instrument displayed.

If you prefer, you can instead drag and drop the instrument from an open **FX Browser** window to an empty area of the track control panel.

The example shown here is for **ReaSynDr**, which requires four outputs. If the item selected (like this one) requires multiple outputs then REAPER will create the initial track and prompt to ask you if you would like the other required tracks to be automatically built. If you select **Yes** the entire output chain will be

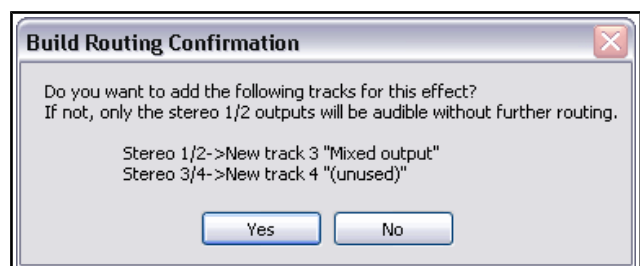
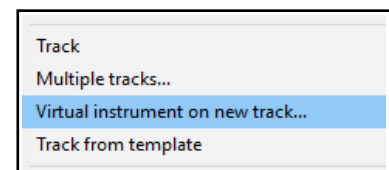
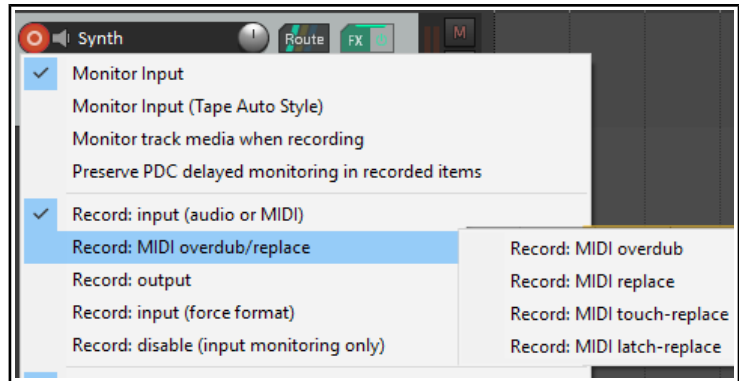

built for you. What exactly this produces will, of course, depend upon which Virtual Instrument you have selected.

Monitoring an External Synthesizer

If you are working with an external hardware synthesizer then it is likely that at times you may wish to monitor its output in REAPER. This topic is covered in [Chapter 13, Manipulating and Editing MIDI Items](#).

3.34 Using Microsoft GS Wavetable SW Synth

You can use the Microsoft GS Wavetable Synth if it is included with your Windows version. It can be used to play MIDI files that you import into REAPER. You will be shown how to import files in Chapter 4.

To enable the Microsoft GS Wavetable SW Synth:

1. Go to **Options, Preferences** and display the **Audio, MIDI Devices** screen.
2. Under MIDI Outputs, right click on Microsoft GS Wavetable SW Synth and select **Enable output**.
3. Click on **Apply**, then on **OK**.

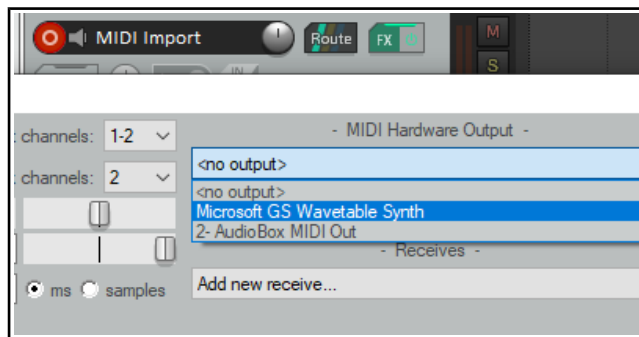
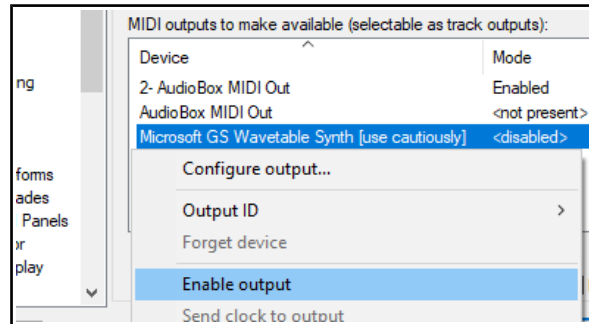

This Synth will now be available as a MIDI Hardware Output.

You can if you wish now use the **Microsoft GS Wavetable SW Synth** as your output device instead of using a software synth (see above right). However, be aware that this output device is known to create issues with latency.

3.35 Looped Overdubbing and Looped Time Selection Recording

Loop overdubbing allows you to make repeated overdubs of a section of recorded material without having to be repeatedly stopping and starting. The technique can be used with both audio and MIDI. In both cases, you will need to check your [Options, Preferences, Audio, Loop Recording](#) settings. Set **When recording and looped add recorded media to project to On stop**. Usually you will also want to enable **In loop recording, discard incomplete first or last takes if at least one full loop was recorded**. You should also (from REAPER's main **Options** menu) disable **Loop points linked to time selection** and enable **Record mode: Time selection auto-punch**.

Now arm your track for recording, select your record options and make your time selection just as you would for normal punch recording. Click and drag along the timeline to create the loop – this should enclose the time selection, as shown below. Make sure **Toggle repeat** (next to Record button) is enabled on the Transport Bar.

When **Record input (audio or MIDI)** is selected,

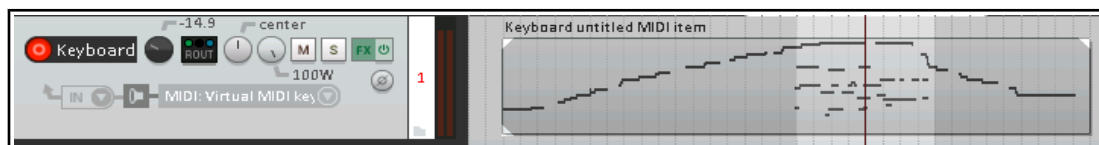

then both audio and MIDI essentially behave in a similar way. When you record, new material will be recorded within the time selection (and added to the MIDI item) for each pass over the loop until you press **Stop**. The loop is used to audition material immediately before and after the section being recorded.

For example, you might choose **Monitor input** and **Record Input (audio or MIDI)** and **Input MIDI** then your MIDI device. If so, the outcome will be similar to that shown here.

Audio material recorded with **Input MONO** rather than **Input MIDI** would produce a similar result, except of course the media items would be audio instead of MIDI. You will, however, get significantly different outcomes if

Recording Audio and MIDI

you use any of the **Record: MIDI overdub/replace** options with looped time selection recording. In each case, new takes will not be created. Instead, the existing take will be edited. For example:

Record: MIDI Overdub: with each loop, the new material will be added to the existing material within the time selection.

Record: MIDI Replace: with each loop, all previous material within the time selection will be replaced with new material. For example, the first loop will replace existing events within the time selection. Second time around it will replace the material recorded in the first loop with new events, and so on. Only the most recent material will be saved.

Record: MIDI Touch-replace: Each time you play a note within the time selection any existing material concurrent with that note will be replaced with new material is on the same channel. For example, if you play correctly except for one wrong note first time, you can correct just that one note second time round.

Record: MIDI Latch-replace: Each time round the loop all existing material in the time selection will be replaced with new material if on the same channel only from the moment you press your first note. This technique can be useful, for example, if you are replacing existing material little by little.

3.36 Recording with External Hardware FX

REAPER can record a track with an external hardware FX device in much the same way as you might use an external device as an insert when recording on an analog desk. You use a plug-in called **ReaInsert**. If you want to try it out step by step, create a new REAPER project file, insert a track, then get your FX device ready.

Example

1. Connect an otherwise unused audio output to the input for your FX device. Connect the output of your FX device to an otherwise unused audio input.
2. Create a new REAPER project file and add a single audio track. Give this track a suitable name. Let's record a vocal with the FX on it.
3. Connect your microphone to an otherwise unused audio input. Switch on the FX Device.
4. Arm the track for recording.
5. Select the input device (to which the line or microphone is attached), select

Monitor track media when recording and specify that you want to **Record output** and choose your required option (such as **Mono, latency compensated**), just as we did in the section **Recording a Track's Output**.

6. Now display the FX Window for this track, and add the **FX VST: ReaInsert** to this window (see right).
7. Specify the actual Hardware Sends and Returns that you set up at steps 1. and 3.
8. Make sure the FX Device mix is set to 100% Dry, and within ReaInsert enable the option **Automatic device latency adjustment**. This allows REAPER to calculate delay compensation as required.
9. With the track's output directed to your headphones, monitor the required Volume and FX Levels, including the FX Wet/Dry mix.
10. When you are ready, Record.
11. When finished, don't forget to disarm the track and set the ReaInsert plug-in status to **Bypass**.

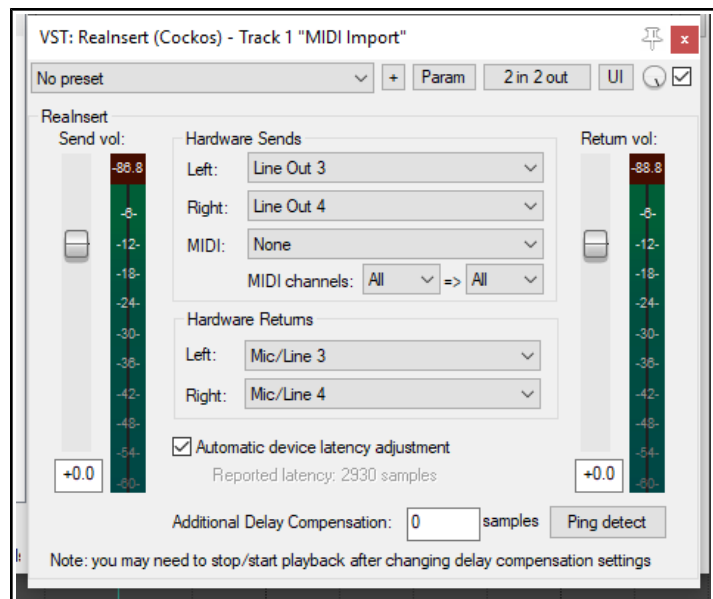

3.37 Preference Settings for Recording

The **Recording** page of **Options, Preferences** determines REAPER's recording behavior, including:

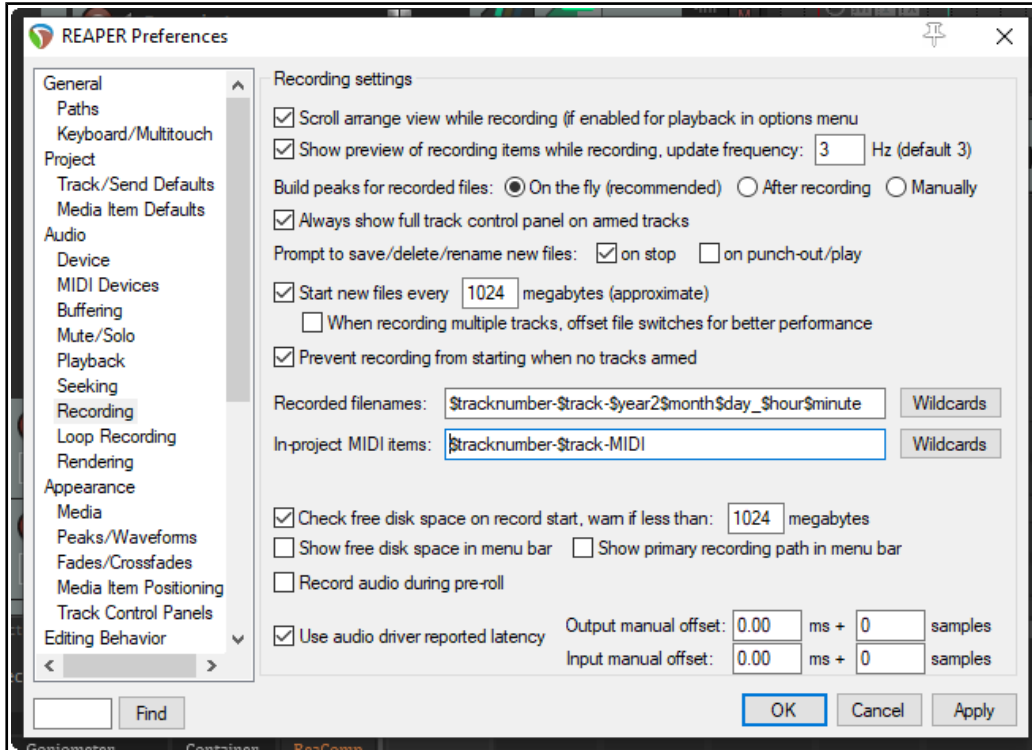

- To scroll track view while recording.
- To display a preview of media item peaks as they are being recorded. This confirms that you really are recording and haven't forgotten to arm your tracks. You can also specify a screen update frequency.
- When to build the peaks for recorded media files.
- To automatically display the whole Track Control Panel (including VU meters) when a track is armed.
- Whether to prompt to save/delete/rename files when recording is stopped. If you disable this option, files are automatically saved.
- Whether to prompt to save/delete/rename files on punch out. If you disable this option, files recorded by this method are automatically saved.
- Whether to start recording to a new file after a specified number of megabytes. This can help to make data secure when recording a long live performance,.
- Prevent recording from starting if no track is armed. You may wish to turn this off if you are using layered recording for a track (or tracks) where recording is not required to start until some way into the song.
- Which items to automatically include in the file names for recorded media – by default these include the track number, year, month, day, hour and minute. Many other options (including project name and track name) are available by clicking on the Wildcards button.
- Which items to automatically include in names for MIDI items created within the project – by default these include the track number and track name. Many other options (including project name) are available by clicking on the Wildcards button.
- To check for free disk space before recording, and to display the amount of free disk space and/or recording path on the menu bar.
- Whether to record audio during [pre-roll](#).
- Whether to use audio driver reported latency: this automatically adjusts media positioning to compensate for the audio driver's reported latency. There are also options for this to be manually adjusted. Beginners especially should leave these at their default settings.

Recording Audio and MIDI

3.38 Track Preferences for Recording

The REAPER **Track Defaults** settings includes a number of items that you can use to help make the recording process a little easier. These settings can be found on the [Project, Track/Send Defaults](#) page of the **Options, Preferences** window. Settings on this page include:

- The default volume fader gain.
- Whether output should be routed to the Main send.
- The default new track height.
- Whether to enable by default Free item positioning or Fixed item lanes. Unless you specifically need it to be otherwise, leave both these off.
- Whether to automatically arm new tracks for recording.
- A Record Config option to set defaults for the Record Arm context menu. Options include, to turn on by default Input Monitoring and specify default record input settings.

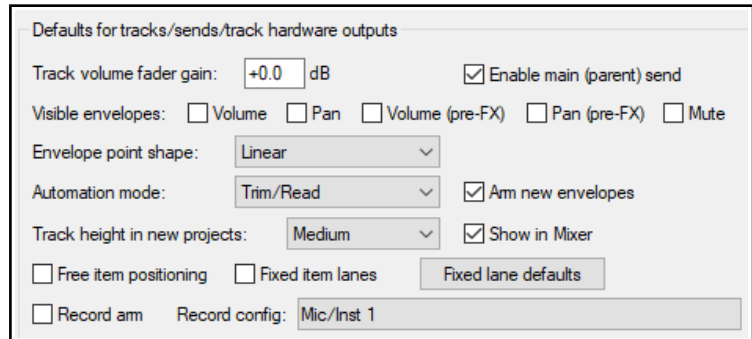

Notice also that under [Options, Preferences, Appearance, Track Meters](#) there are settings which together determine how your track VU meters are presented.

For example, you can choose whether or not to **Show track input when record armed** and to **Make obvious that track input is clickable**.

Disabling this latter option may improve the clarity of the display on your VU meters. Enabling **Show dB scales on record armed track meters** and **Sticky Clip Indicators** helps you to monitor peak levels. MIDI users may wish to **Show MIDI velocity on track VU** and/or **Show MIDI output activity on track VU**.

You can also specify whether to **Reset peak indicators on play/seek**. If enabled, the numeric peak indicators on track and master VU meters will cleared when playback is restarted or the play cursor moved.

There is also a global option for **Track meters display pre-fader levels**. This setting is also available from REAPER's Options menu.

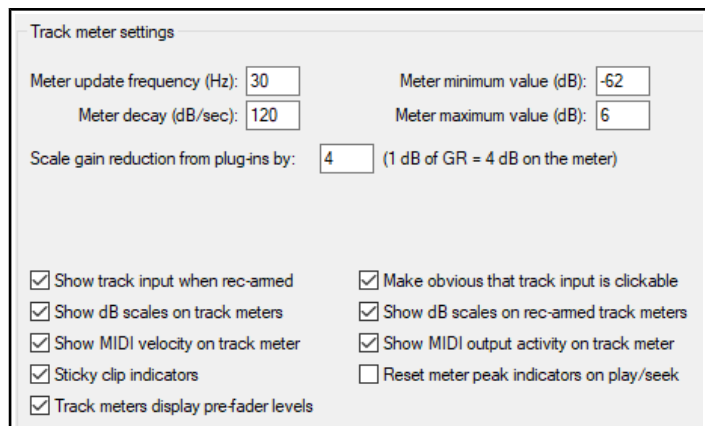

3.39 Other Track Recording Settings

REAPER allows you to use different audio formats for different tracks in the same file. The default format for new tracks will be determined by your [Project Settings](#). To change these for any track, simply right click over either the track's record arm button or its record options button, then from the menu choose **Track recording settings**.

You can choose any of the formats **WAV, AIFF, DDP, FLAC, MP3, OGG Vorbis, Video (GIF)** or **WavPack lossless compressor**.

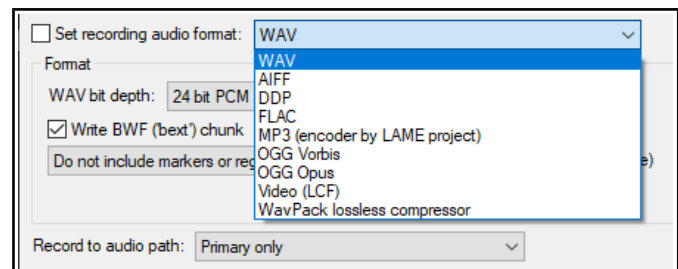

Depending on the format you choose, you will be presented with a range of options appropriate to that format. There is also an option to include markers/and or regions in the recorded material.

Up and Running: A REAPER User Guide v 7.31

3.40 REAPER Audio Recording Checklist

The following checklist is for guidance only. In some cases you may vary the suggested order (e.g., you can switch on your PC and start REAPER before getting together your microphone and leads). In other cases the order is critical (e.g. you should always connect your microphone to your preamp before turning on the phantom power supply). If you are not sure, keep to the exact same sequence outlined here.

Item	Comment
Preparation	Set up all external recording equipment needed (microphones, stands etc.). All faders and gain controls on mixer and/or sound device turned right down. Phantom power (if available) turned off. Everything connected that needs to be connected (e.g. microphone leads to mixer or sound device). Turn equipment on, but check volume on speakers isn't too loud. Connect headphones to headphone amp or sound device. If phantom power required (for condenser microphone), turn it on.
PC Preliminaries	Turn on PC and wait for Windows to open. Open REAPER with required project file. Save file.
Project Settings	Check recording format and settings – e.g. 24 bit WAV at 44100 Hz. Is a different format required for this track? Make sure Record Mode is set to Normal.
Track Settings	Named and armed for recording? Track Input Monitoring on or off? Use the Sound Card's direct input monitoring if available in preference to REAPER's. Record Input selected? Correct input channel selected?
Test Recording Levels	Start low and work up. Record a small sample to test levels: the three examples here show (left to right) too low, too high and about right. It is better to be too low than to be too high.
Recording	Press Ctrl R to record and again to stop recording when finished. Save media items. Press Ctrl S to save project file.
Evaluating	Unarm track before playing back recorded tracks to evaluate them. Especially if listening thru headphones, disable Input Monitoring (or turn faders and gain controls on the input device right down), to prevent live ambient sounds from being mixed in with your recorded material.



3.41 Recording MIDI From Keyboard Checklist

Newcomers sometimes run in to trouble when recording MIDI from an external MIDI keyboard. If you find things aren't happening as you would like them to, here are some things to check:

- Is the keyboard sending MIDI on the required MIDI channel?
- Is the keyboard device enabled in Preferences for Input/Control?
- Is the keyboard selected as the input device for the track?
- If needed, is the correct MIDI channel from the keyboard selected?
- If needed, is the input mapped to the correct MIDI channel?
- Is record arm enabled?
- Is input monitoring enabled?
- If needed, is the plug-in "listening" to the required MIDI channel.

Recording Audio and MIDI

3.42 Recording an Internet Audio Stream

You can use REAPER to record an audio stream from the internet. Before doing so you should make sure that you are not in breach of any copyright restrictions. The exact method will depend on your hardware setup, including your sound card. Your sound card should include some sort of software for changing its settings. This may or may not have its own icon within the Windows Control Panel. If you are not sure how to access it, you can click on the Windows **Start** button, choose **Run**, then type **sndvol32 -r** and press **Enter**. In overview, these are the steps that you will need to perform.

1. Access your sound cards control software and modify its settings to select (depending on the options available) the required option. You should probably temporarily disable input from all other sources (Microphone, Line, etc).
2. Open your web browser and find the page containing the item that you wish to record.
3. Open REAPER, create a new file and add a track.
4. The next step may require a little experimentation. Depending on the equipment you are using, it might be necessary to change your **Options, Preferences, Audio, Devices** settings to **Direct Sound**. An example is shown here. These settings may not be the best for your particular system.
5. Arm your track for recording: be sure to select the correct input.
6. Press **Ctrl R** to start recording. In your web browser, play the item that you wish to record. When finished, stop recording and save your work.

Note: Don't forget when you have finished, to restore both your Sound Card Recording Control options and REAPER's [Audio Device Preferences](#) to their previous settings.

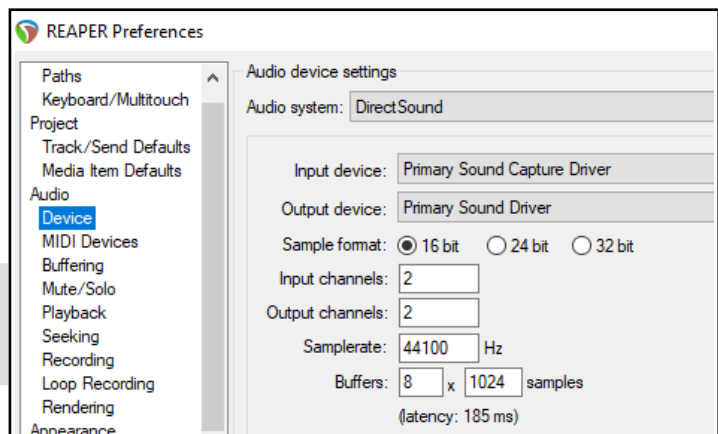

3.43 Converting Audio Media Item Format

In this internet age it is becoming increasingly common for musicians to want to collaborate on projects all the way across the world. Consider this scenario. You have a part recorded project of perhaps 50 or more 24 bit

wave files. In some far off land you have a friend who has offered to lay down a track such as a flute. You'd like to get your source files to her, so that she can do this for you, layering it down against whatever headphone mix best suits her.

However, your recorded material so far comes to over 3 GB and she doesn't have a particularly fast internet connection.

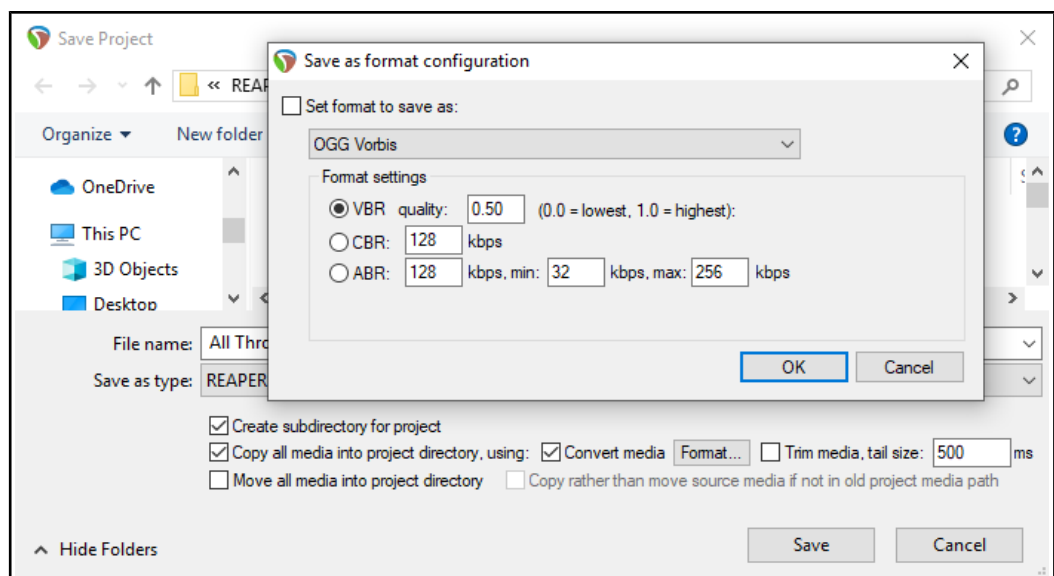

Up and Running: A REAPER User Guide v 7.31

One solution could be to convert the files to a compressed format and send her those. There's a quick way to do this, using the **File, Save project as ...** command. Choose this command and follow these steps.

1. If you wish, navigate to a required parent folder.
2. Enable the three options to **Create subdirectory for project, Copy all media into project directory,** and **Convert media.**
3. Click on the **Format...** button to display the settings box shown above.
4. Enable the option (top left) **Set format to save as.**
5. Select your required format (e.g. FLAC, MP3 or, as shown here, OGG Vorbis).
6. Specify your preferred format settings.
7. Click **OK** then **Save.**

All audio media items in the project will be converted to the specified format as they are copied across. The format of the original items will remain unchanged.

You can also convert and export selected individual media items from one format to another without having to convert the whole project. This topic is covered in [Chapter 21](#).

3.44 Recording Live Windows Output

Windows users (Vista/7/8/10 and 11) can use WASAPI drivers to record live Windows output (for example, subject to copyright constraints, a YouTube video). This requires the use of feedback looping, so you should proceed with caution beyond this point. This is not recommended for beginners.

First, create a new project file. Display the project settings (**Alt Enter**) and on the Advanced page enable **Allow feedback routing**. This is also known as "loopback recording."

Next, display your **Preferences, Audio, Device** window and select **WASAPI** as your audio system. Select **Shared loopback** mode (see right). Your block size and sample rate will need to match those of your sound device, as set in the Windows Control Panel.

Finally, you simply add a new track and arm it for recording. You will probably want to set input to stereo.

Mute the track's audio output and press **Ctrl R** to record whatever you are currently playing in Windows. For example, this might be a

YouTube video that you are currently listening to over your speakers.

Note: If your computer has both an internal sound card and an external one (such as Focusrite Audio Box or Presonus Studio) you might need to resolve any possible conflict before doing this. One way could be to access your Window Control Panel's sound settings and to temporarily disable the internal sound card and/or make the external card the default.

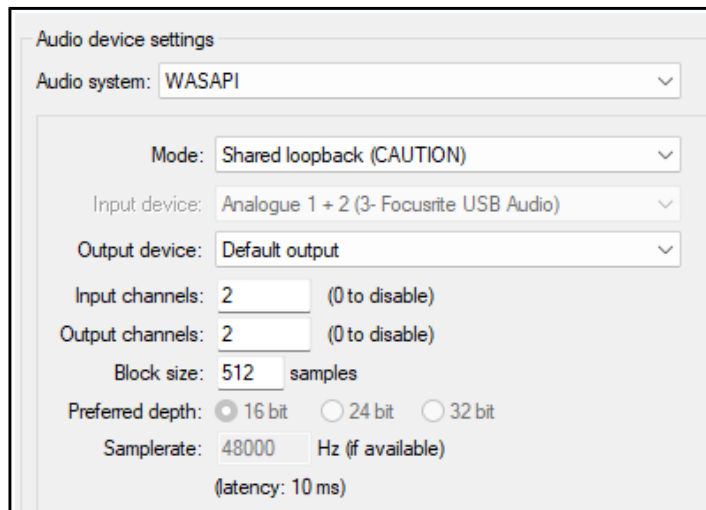

Managing Media: The Media Explorer

4 Managing Media: The Media Explorer

4.1 Introduction and Overview

To open the Media Explorer, use the **View, Media Explorer** command, or the shortcut **Ctrl Alt X**. Its interface is shown in the diagram below. Like many other windows, the Media Explorer is dockable. To do this, click the last button on the toolbar, or right click on the title bar and choose **Dock media explorer in docker**.

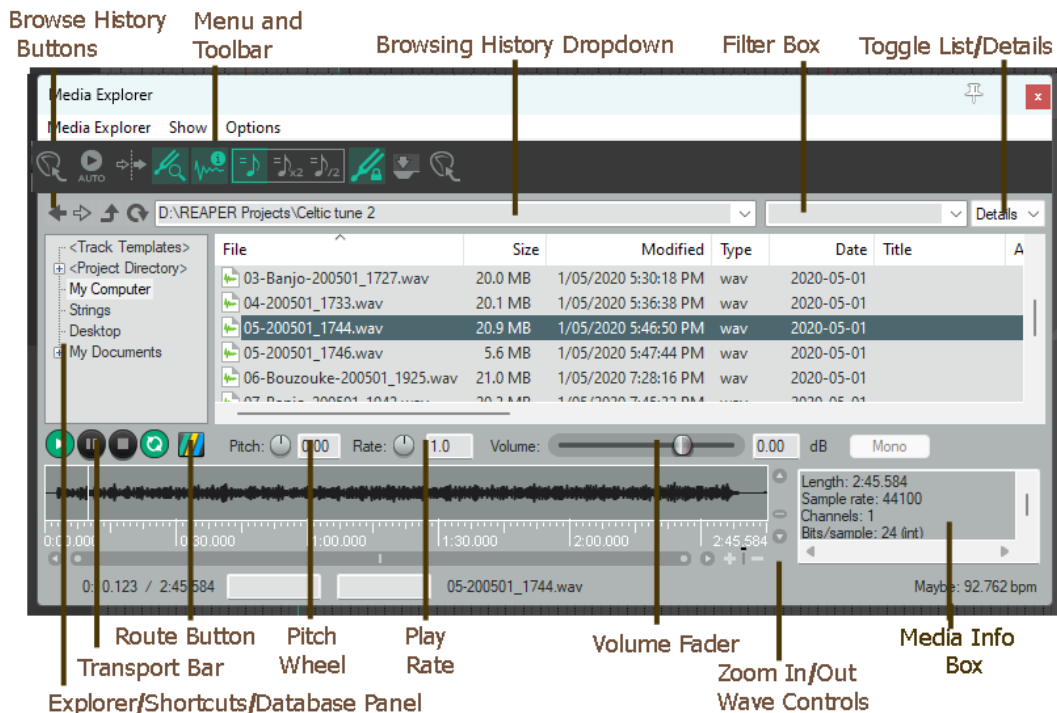

The Media Explorer can be used to preview and import items into your projects. To make this faster, easier, and more flexible, it incorporates a number of features to assist you in organising and managing your media files. This includes the creation and management of databases (libraries) and by adding or editing media file metadata. Before exploring its many features, let's look at the various elements of the Media Explorer window:

Toolbar buttons (L to R): **Insert** item in project: **Auto play**, **Start on bar**, **Detect Pitch** and **Media information box** toggle options: **Tempo match options**. Set tempo match off, or on, or to double, or to half. **Preserve pitch** toggle option: **Dock media explorer** toggle.

Explorer/Shortcuts/Databases panel. Used to navigate your directories and files, rather like Windows Explorer or Mac Finder. you can add shortcuts for any folders and set up/manage databases.

Browsing history buttons. Four buttons - previous, next, up a level and refresh – to use for browsing.

Browsing history dropdown. This stores (and can display) a list of recently visited folders and databases. You can select from this list to access any of these folders.

Filter box. Use this to type a text string to filter the displayed file list.

List/Details (Windows only). Selects whether file details (size, date, etc.) or only file names are shown.

Transport bar. Works with selected media item. Controls are Play, Pause, Stop and Repeat.

Route button. Directs output to any audio output, or to play thru any track selected in Arrange View.

Pitch control: Adjusts pitch of selected item on playback.

Rate control: Adjusts play rate of selected item on playback.

Volume control. Adjusts volume of playback of selected item.

Preview window: Displays peaks (waveforms) of currently selected item, including ruler display.

Preview scroll bars: Horizontal and vertical bars allow you to zoom in/out of the preview window. The action list includes an option to toggle this on/off.

Although more commonly used for organising, finding and inserting media files, the media explorer can also be used to find, preview and open existing .RPP project files.

Up and Running: A REAPER User Guide v 7.31

4.2 Media Explorer Basics

REAPER's Media Explorer allows you to create your own folders and databases. Folders and subfolders that you create in REAPER's media explorer will be real folders, stored in Windows Explorer or Mac Finder. Databases, however, will exist only in the media explorer, and have no purpose outside of REAPER's media explorer.

The media explorer can be used to manage not only audio items (.WAV, .MP3, etc) but also midi files (.MID), automation items (.ReaperAutoItem) and even REAPER project files (.RPP).

In order to do this ...	Do this ...
Generally manage Media Explorer	Right click on title bar for menu which includes Dock media explorer in docker , Show action list , and Close window on escape key (see also section 4.11).
Browse thru your folders	Use the Explorer/Navigation panel in conjunction with the main panel. For example, click on My Computer (Windows) or Home (Mac) in the left hand panel, then use the main panel to browse thru and to open your folders.
Create shortcut for any folder	In the main (right hand) panel, right click on folder name and choose Add to shortcut list from menu. Shortcuts are displayed in the left hand panel.
Rename folder shortcut	In the shortcuts (left hand) panel, right click on shortcut, choose Rename shortcut . Type a name and press Enter or click OK .
Reorder shortcuts	Drag and drop shortcut name(s) up or down the list in the shortcuts (left) panel.
Remove shortcut	In the left hand panel, right click on shortcut, choose Remove shortcut .
Create a subfolder on shortcuts list.	Right click on folder name in shortcuts panel. Choose Create subfolder . Type a name then press Enter or click OK .
Copy to subfolder	Drag and drop files from main (right hand) panel.
Select/restrict columns displayed	Right-click on any column header then Show/hide columns for a columns list: tick/untick to select columns. Available fields are Favorite, Mark, File Name, File Size, File Modified Date, File Type, Title, Artist, Album, Track number, Date, Genre, Comment, Description, BPM, Key, Custom Tags, Length, Channels, Sample Rate, Bits/Bitrate, Start Offset, Peak Volume and Loudness. There are actions available to calculate peak volume and loudness statistics . Add user column allows inclusion of other read only metadata or your own text.
Column order presets	The column header context menu includes options to Save , Load and Delete column order presets , and to Restore columns to default order/width .
Change column order	Drag column header, left or right as required, or right-click on column header and use Move column to far left (Ctrl shift click) from context menu.
Manage folder/file display	Click on any header to sort by that column – e.g. File or Size. Click again to reverse the sort order. If Custom tag column is displayed, double-click in this column for any file displayed to edit the custom tag. This can be any plain text that has meaning to you, such as Instrument or Quality. Right-click on any column header for option to Show/hide columns . Drag/drop header left or right to change column order. There are also context menu options to Group favorites on top and/or Group folders on top and to Reset columns to default order/width .
Use search/filter file list <i>See also the section Using Search Filters for advanced options.</i>	Type text string (e.g. bass) in the filter box (left of the list/details dropdown) to filter file display. Boolean search (AND, OR, NOT) is supported, e.g.: kick OR snare: for file names that include either <i>kick</i> or <i>snare</i> such as Pop_Dance_Snare 02.wav, Pop_Dance_Kick 05.wav urban AND kick: for file names including both <i>kick</i> and <i>urban</i> such as Urban_Kick 01.wav, Urban_pop_Kick 03.wav but not Kick.wav Use ^, \$ and quotes to match start/end/whole word – e.g. ^bass, bass\$, "bass". Delete the text string to remove the filter. Right click on filter box for a field list to limit search to selected field(s).

Managing Media: The Media Explorer

In order to do this ...	Do this
Fav / Mark (toggle)	Double click in either of these columns to label a file as Fav or Mark .
Restrict file information display options	The Show menu toggles on or off what the media explorer will display: All files (otherwise only media files such as .wav, .mp3, .mid are shown) Folders and/or File extensions even when file type displayed Leading path or Full paths in databases and searches Toolbar and/or Media information box Path dropdown box and/or Shortcut list Vertical layout (toggle navigation panel above rather than left of files list)
Restrict search options	The Search submenu (Options menu) toggles customization features on/off: Search fields (make searchable any or all of: File name, Leading path, Title, Artist, Album, Year, Genre, Comment, Description, BPM, Key, Custom tags). Folder searches (any/all of Search in metadata, Search in subfolders, Include matching folders). Read file metadata is another option. Include matching folders (shows sub-folder names in search results) Whether to Update searches only when the ENTER key is pressed .
Add to shortcuts list	Right click on folder name in main panel, choose Add to shortcut list .
Change date format	Right-click on any column header, choose Set date/time format ...
Other Options, Search toggles	Update search only when Enter key is pressed Clear search when browsing to new folder or database
Navigate thru browsing history	Open browsing history dropdown: all folders and directories visited during your current session will be listed. Additionally, the buttons located to the left of this dropdown can be used to move back and forwards thru your browsing history.
Show/hide media information box	Use the second toolbar icon, or the Show, Media information box command. – typically shows length, sample rate, etc. Right click for a context menu.
Manage toolbar	Use toolbar context menu commands to Open or Switch to a different toolbar, or Position toolbar (in media ex, float, dock or close) or Customize it.

4.3 File Management

File management in media explorer appears similar to Explorer or Finder, but with several enhancements.

In order to do this ...	Do this
Copy a file from one folder to another	Ctrl left drag the file from the file list (right hand panel) to destination folder in the left hand panel, <i>or</i> ... Right click on file name, choose Copy . Select destination folder in left panel, right click in right panel and choose Paste .
Copy file into media explorer	Ctrl Alt left drag file from arrange view into media explorer main area. Renders item to a new file, applying any item FX etc..
Rename a file	Right click on file, choose Rename from menu. Type new name, press Enter .
Delete file	Right-click on file name, then choose Delete then OK to send to recycle bin.
Show file properties	Right click on file name, choose Show media source properties from menu.
Show file list in Explorer or Finder	Right click on any file name in list, choose Show in explorer/finder . (Windows Explorer or Mac Finder).
Working with non media files	Enable Try to open non media files (Options, Default action menu): double clicking on files such as .jpg,.doc will then if possible cause them to be opened.
Cause them to Open actions list	Show action list (Media Explorer menu) opens the media explorer actions list , in order to run other actions and/or assign keyboard shortcuts. See section 4.11 .
Customize menu	For example, to add actions to the media explorer menu, choose Options, Customize menus . See Chapter 15 for more about menu customization.

4.4 Working With Metadata

Metadata is information about your audio or midi files that can be embedded within the files. Categories of metadata recognised by REAPER's media explorer are Title, Artist, Album, Date, Genre, Comment, Description, BPM and Key, as well as Custom Tags. Custom tags can be used for other information that you might wish to include.

Before looking more closely at how the media explorer handles metadata, there are some basic issues that you should understand. These are:

- Existing metadata already embedded in files that you purchase and/or download will be displayed in media explorer provided, of course, that you have made those columns visible.
- You can sort, search and filter the list of files displayed using the contents of any metadata field, provided these are enabled in your **Options, Search options**. There is also an option to **Group favorites on top**.
- Within media explorer you can add metadata to most kinds of audio files, including .WAV, .MP3, .OGG and .FLAC.
- Metadata that you add to any files in media explorer, including your own recorded material, will be displayed in media explorer and can be used for searching etc., but by default will not be embedded in the files. You do, however, have an option to write the metadata into the file so that it will then be embedded.
- Some metadata fields will be displayed in popular music software (such as Windows Media Player and Groove Music) and portable MP3 players and will be displayed as the music is played. Typically, these will include Title, Artist and Album.

In order to do this ...	Do this
Enter/Edit metadata in a single file	Double-click in the required column (e.g. Title) for that file, type the metadata and press Enter .
Enter/Edit metadata in several files.	Make file selection in the main panel file list. Right click over any file in selection, choose Edit metadata tag then select required field (e.g. Artist), type the text and press Enter .
Restore metadata to last saved state	Select file or files. Right-click over any selected file, choose Re-read metadata from media files .
Embed metadata in a single file or several files	Select file or files. Right-click over any selected file, choose Write edited metadata to files .

4.5 Creating and Using Databases

You can create your own databases to manage your samples and media files. This lets you display together files that have a common theme but might be stored in different folders. A database can contain a selection of files, entire directories, or both. Think of databases as being for file reference and retrieval rather than storage.

Individual files can be referenced from more than one database. For example, you could create a database called "Drums Various" for all your drum samples. You could also create separate databases each for toms, snare, kick, etc. Databases are set up and managed using right-click context menus in the left-hand **Shortcuts** panel.

In order to do this ...	Do this
Create a new empty database	Right-click over empty area in left (shortcuts) panel. Choose Create new database... from menu. Type name, press Enter .
Add file(s) to database	Select file(s) in media explorer's main window, then drag and drop to the database name in the shortcuts panel. Note that the same file(s) can be added to more than one database if you wish.
Mark files as favorites (toggle)	Select item, double-click in Fav column to mark. By default, this is the first column in the folder/file display area. Repeat this to unmark. One use for this is to be able sort file display to show favorites first.

Managing Media: The Media Explorer

In order to do this ...	Do this
Add folder (directory) with contents to database	<i>EITHER ...</i> Select database in Shortcuts column. Right-click over its name and choose Add path to database ... from menu. Navigate to required folder, select it and click on OK . Repeat this to add more folders. <i>OR...</i> Drag and drop folder from windows explorer or mac finder, or media explorer's main window on to the database name in the shortcuts panel.
Change shortcut name of folder in database	Right-click on folder name in shortcut panel, choose Rename shortcut... Does not change folder name on hard disk.
Create a new database from a folder	In right hand panel, right-click on folder, choose Make database from folder . By default, the database will take the folder name, prefixed DB: and will be included in the list in the left panel.
Change order in which databases are listed in shortcuts panel	Drag and drop database name up or down.
Remove a folder contents from database	Select database in Shortcuts column. Right-click over its name and choose Remove path from database... from menu. From the flyout list, select the folder that you want removed.
Remove item(s) from database	Select item(s) in media explorer window. Right-click over selection, choose Remove items from database .
Change database name	Select database in Shortcuts column. Use Rename database... command on context menu. Does <i>not</i> erase items from disk.
Update database contents to reflect changes in folder contents	Select database in Shortcuts column. From context menu use Scan database for new files to find and add new files, Remove missing files from database to remove deleted files.
Remove a database	Right-click on database in Shortcuts column, choose Remove database .

Media explorer databases can be included in your **export configuration** settings ([Options, Preferences, General](#)): see also [Chapter 22](#).

4.6 Media Item Preview

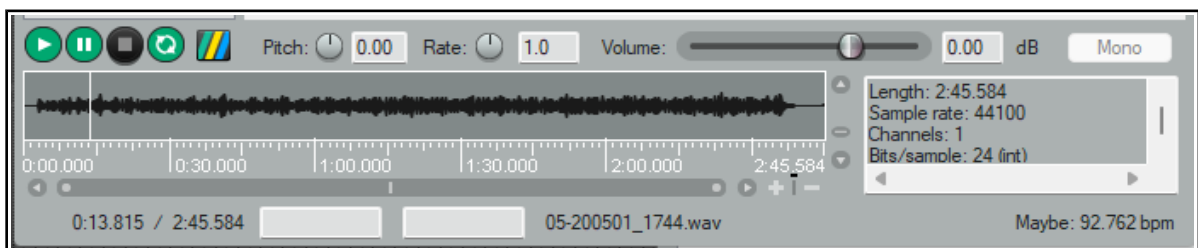

Usually you will want to audition items before inserting them into a project. The media explorer allows you to do this. The Auto play option (on the toolbar) can be used to ensure that by default an item is automatically played when you select it. You also have a number of options available which determine exactly how the preview feature will behave. Also, as you will see in the section that follows this one, you have a great number of options for determining just how items are inserted into your project.

Use the **Media Information** tool (on Media Explorer toolbar) to toggle display of the media information box. Also, identify the main playback controls. The **Transport Bar** buttons (L to R) are Play, Pause, Stop and Toggle Repeat. The horizontal fader (far right) adjusts the volume of playback. Now make yourself familiar with the following features:

For a bound hard copy of the latest version of this User Guide (printed in B&W) go to LULU.com

Up and Running: A REAPER User Guide v 7.31

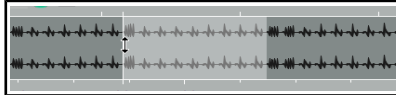
In order to do this ...	Do this
Select a file to audition	Recommended: make sure Always show waveform peaks for selected media on the Options menu is enabled. Click on file in media explorer main panel, or use the keyboard up/down arrow keys on your to move thru the list.
Preview an .RPP file	Enable Preview REAPER.RPP projects in Options menu. Select .RPP file within media explorer. You can also enable Do not auto-render .RPP proxy .
Select a preview panel display option	Use Display preview position options on Display menu – e.g. beats using embedded tempo, whole or fractional beats or seconds.
Audition a file: play and stop	Select file in main panel. To start, click Play button in preview panel, or press the right arrow key or spacebar on your computer keyboard. To stop, click on the Stop button in the preview panel, or press the left arrow key or spacebar.
Calculate/show loudness stats for item	Choose Calculate peak volume and loudness (LUFS-1) for media from the item right click context menu.
Play item as a continuous loop	Enable the toggle repeat button on the preview toolbar.
Preview with start on bar enabled	Enable Start on bar (on toolbar). Optionally, enable When start on bar enabled, wait for next bar to start preview (Options menu)
Audition only a portion of a file	Make time selection and use spacebar to start/stop. Drag and drop from either end of selection to extend/shorten it. 
Zoom in/out of waveform	Scroll mousewheel up/down.
Scroll zoomed waveform	Shift drag left/right, or Shift mousewheel up/down.
Adjust height of peaks display	Hover mouse over top of display area to show mouse cursor as a double-headed arrow. Drag up or down.
Play all files in sequence (needs repeat to be off)	Select Auto advance to next file after preview from the Options menu. Press Spacebar .
Automatically audition file when selected	Enable the Auto play tick box.
Synchronize to current project	Enabling Start on bar will ensure that in auditioning the item during project playback, the item playback will be co-ordinated so as to start on a bar.
Audition item within current project	Click on the Routing button and enable Play thru ... selected track . Insert a new track into your project and keep it selected. If you wish, enable both Repeat toggle and Start on bar . When started, playback will be thru the selected track – you can experiment with volume, panning, track FX, etc. When you also play the project, you will hear the item played with the project.
Use crossfades (optional)	The Options menu has an option to Crossfade when switching between items . The Configure crossfade option lets you set crossfade length,
Tempo match (use toolbar to toggle and choose options)	With this on, the tempo of the selected item is matched to that of the project. Other options include Tempo match half and Tempo match double .
Modify volume	Use Options menu to Apply preview volume to inserted media .
Pitch/Rate rotaries and Volume fader	Use these to make adjustments while auditioning, or type values in edit boxes next to the controls. The Detect pitch toolbar button displays the pitch in the preview window when auditioning. Enable Options, Apply preview pitch rate to inserted media items to apply pitch when inserting a media item.

For a bound hard copy of the latest version of this User Guide (printed in B&W) go to LULU.com

Managing Media: The Media Explorer

In order to do this ...	Do this
Pitch and rate options	Right click on either the pitch or the rate control knob for a context menu of options, also available from the Media Explorer Options menu: Preserve pitch when tempo-matching or changing play-rate (toggle) Reset pitch and rate when changing media (toggle) Pitch shift knob behavior (options are Continuous, Cents, Quarter tones, Semitones) Pitch shift knob range (options are +/- 2, 6 or 12 semitones).
Normalized volume options	The Options menu includes Normalize preview volume [to -0 dB or -12 LU] if peak volume has been calculated , and Apply normalized volume to inserted media items . See also Media Explorer Actions .

4.7 Inserting Audio Files, Samples and FX

Selected media items can be inserted into the current project either from the media explorer's toolbar, or from the main window by right-clicking on the file name and choosing one of the options (see below). These are:

- Insert into project** (on currently selected track, at current cursor position)
- Insert at time selection (stretch/loop to fit)** (if a time selection is currently active)
- Insert on a new track** (at current cursor position)
- Insert into sample player** (on new track, or reusing existing sample player)
- Insert in selected item** (as new take, replacing media source, or replace media source -stretch/loop to fit: when replacing source media only the active take will be stretched)

As a shortcut, you can specify one of these options (or something else) as your default behavior, then apply that to a selected item by double-clicking or pressing **Enter**.

You can set your default behavior preference using the **Options, Default action (double-click or enter key)** command. This menu is shown here (right). The default settings are to **Insert media on selected track** (media items) or (for .RPP files) **Open projects in new tab**. We'll get to .RPP files shortly.

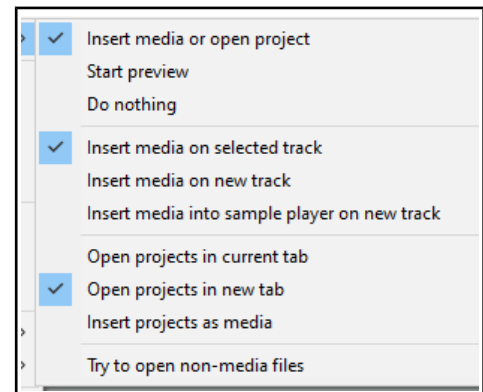

To disable this shortcut altogether, choose **Do nothing**. To assign your own shortcuts to any command, go to the media explorer section of the actions list: right-click over the Media Explorer title bar and choose **Show action list** from the context menu.

Some of these options appear might self-explanatory. For example, **Insert on a new track** creates a new track and inserts the selected item there, at the current cursor position. Alternatively, we could just drag and drop. Sounds simple? Not always, because we might need to ensure that the item we are inserting syncs with our other instruments. Let's look at how to use the media explorer to our best advantage in this and other situations.

Example 1 – Insert at time selection

Here we have inserted a synth sample and looped it as shown. We wish to add some strings. We find a sample that we like, but it needs to be synchronized with the synth.

We make a time selection equal to the first instance of our synth. We set **Tempo match on** and then **Insert at time selection (stretch/loop to fit)**. The new track syncs with the existing material and can itself be looped.

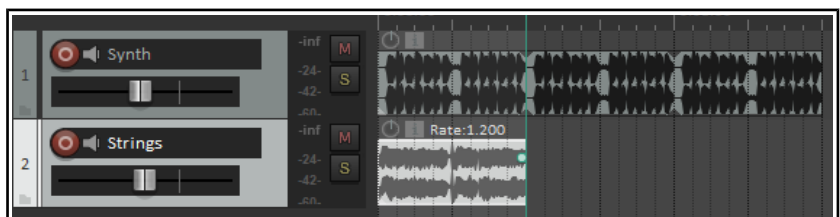
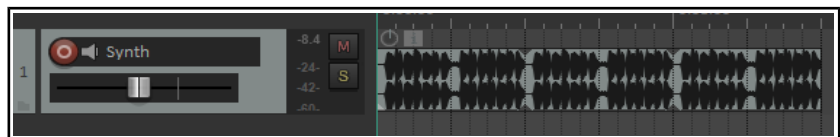

Example 2 - Insert in selected media items (Replace media source)

We have inserted a series of empty media items to mark where we want a hat to go .

We select all the media items, choose a sample, and with tempo match on choose

Insert in selected media items, Replace media source (stretch/loop to fit).

This command could be used to replace one sample throughout a song with another.



Example 3– Replace source media using drag and drop

1. Select the item in media explorer.
2. Hold **Ctrl Alt** while you drag and drop to the media item whose source is to be replaced. Make sure that the start position of the item to be inserted does not occur before the start position of the existing item.
3. The dialog box shown here will pop up. You can choose **Insert new media item that overlaps target media item**, **Add source media as new take in target media item**, **Replace target media with source media** or (if there is more than one instance of the item) **Replace all x occurrences of the target media with source media**.
4. Specify your preference as to whether to **Adjust target media item length to fit source media**, **Stretch source media to fit target media item**, or **Loop source media to fit target media**.

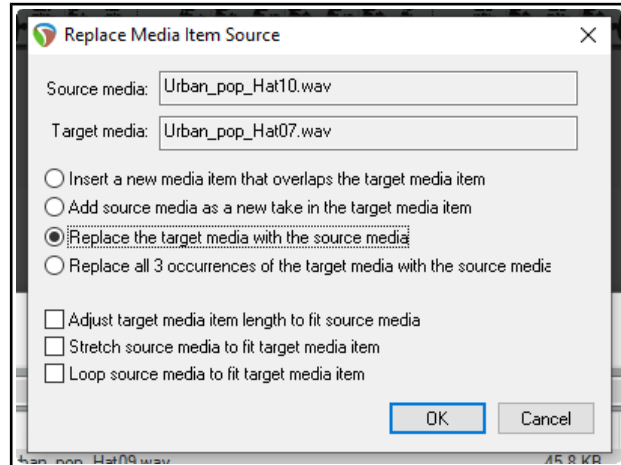

When media is dragged into a project, media explorer settings to preserve pitch when changing rate or tempo-matching will be respected.

Example 4 – Inserting an item as a new take

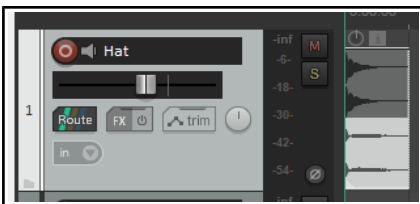

In this example, after inserting one sample into a track, a second has been inserted using **Insert in selected media items (Insert as new take)**.

This item can now be looped, copied, pasted, split, etc just like any other and any desired permutation of the takes can be selected (as shown, for example, below).

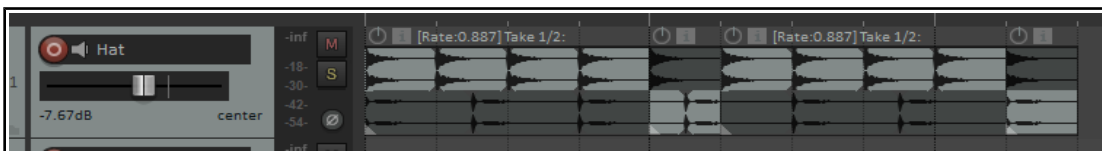

Example 5 – Inserting an item as new track immediately above an existing track

You can drag and drop a media item to insert it on a new track which will be created above an existing one. The **Options, Preferences, Media** option to **Allow drag import to insert tracks** needs to have been enabled.

Drag and drop the item so that the mouse is hovered in arrange view on and near to the top of the existing item above which you wish to insert it, and at the position in the timeline where you want it inserted.

A tooltip **Insert track** will be displayed. Release the mouse, and the item will be inserted on a new track immediately above the track containing the existing item.



Managing Media: The Media Explorer

Example 6 – Insert an item into sample player

Selecting a sample and then choosing **Insert into sample player (insert sample player on new track)** will cause a new track to be created with ReaSamplomatic5000 inserted into its FX chain, pre loaded with the selected sample.

To replace the sample with another simply select the track, select the required replacement sample and choose **Insert into sample player (reuse active sample player)**.

The **Options menu** includes several options for **Assign MIDI when inserting into a sampler**. These are:

Assign detected pitch

Assign MIDI note C4 (60) and increment if new track ...

Assign MIDI channel and increment if new track and

Do not assign pitch, note or channel (the default)

Example 7 – Inserting an automation item

Automation items can be previewed in, and inserted into projects from, the Media Explorer in the same way as other media items, and with the same appropriate options. See also [Chapter 18 for more information](#).

Example 8– Insert part of a media item into a project

1. In the preview window select the portion of the waveform.
2. Right click over the selected portion and choose one of the items from the context menu.
3. The item can be loop enabled or disabled. It can be inserted at a time selection, on a new track, or as a new take on a selected item. Also, a portion can be dragged and dropped into the project, in which case your default settings will be applied.

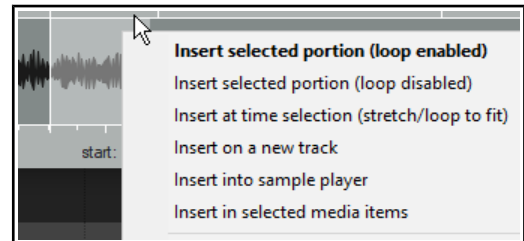

Note: The **Options** menu allows you to **Enable looping when inserting selected portion of items**.

Example 9 - Insert multiple media item into a project

1. Use **Ctrl click** to build your selection.
2. Right-click over the selection and choose from the menu.
3. Alternatively, drag and drop the selection into the project. Unless you have changed the default setting, you will be prompted to select whether you want the items inserted on one or separate tracks.

Note: The Media page in REAPER's Preferences includes a default setting when inserting multiple items:

Insert in one track (advancing time) – each is placed one after the other.

Insert across tracks – each item is placed in a separate track, all starting together.

Decide automatically – if files are of the same length (file size) they will be placed in separate tracks, otherwise they will be inserted sequentially in the same track.

Prompt user – you will be prompted each time to specify your preference.

If in doubt, set this to **Prompt User**. Other useful options include whether or not imported media items should be copied to the project media directory. See [Chapter 22](#) for more details. Note also that the [action list](#) includes options to **set media item start, end or both to match source media**.

Example 10– Insert multichannel audio files

Multichannel audio files are imported into REAPER in exactly the same way as any other item. An example of such a file (in this case six channels) is shown here.

You can split such a file into its individual channels, to produce one track per channel. This allows for each channel to be edited independently of the others. To do this, right-click on the item and choose **Item processing, Explode multichannel audio or MIDI items to new one channel items**.

Example 11 – Inserting an FX chain into a track or item.

Make sure that the option (**Show** menu) to **Show all files** is enabled.

To add the FX to any existing chain, drag and drop any FX chain to the track panel, or onto any media item to insert the chain into that item.

Hold **Alt** while dragging to replace existing FX with the chain.

Example 12 – Importing tracks from an audio CD

To import material from an audio CD :

1. Insert the audio CD into your PC CD drive.
2. Display media explorer, select **My Computer** in the left panel, then double-click in the main panel on the letter representing CD drive. Its contents will be listed.
3. To play (preview) any track from the CD, right click over it and choose **Preview** from the menu.
4. To insert a CD track into your project as a media item, in media explorer's main panel right click over that track and choose one of the other commands from the menu. Each of these commands works as explained earlier.

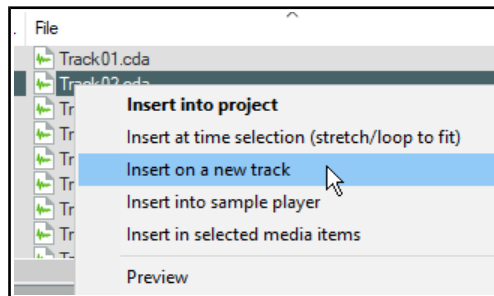

Note: By default, fade settings as specified in **Preferences, Project, Item Fade Defaults** are applied to all imported media items. You can disable this option on the Item Fade Defaults settings page.

4.8 Import Media File Types

Media files of any of the following types can be imported into REAPER in any of the following formats.

AIFF (.AIF, .AIFF)	MIDI System Exclusive Message (.SYX)	PCM Audio (.PCM .L, .R)
AVI Video (.AVI)	MPEG Video (.MG, .MPEG)	Quicktime (.MOV, .QT, .M4V, .MP4)
CAF (.CAF, .CAFF)	LCF Capture Video (.LCF)	Recycle (.RX2, .REX, .RCY)
CD Audio (.CDA)	MKV Video (.MKV)	RAW audio (.RAW)
DDP (.DAT)	MPEG Audio (.MP2, .MP3)	Sound Designer II (.SD2)
FLAC (.FLAC)	MusicXML (.XML, .MUSICXML, .MXL)	WAV (.WAV, .W64, .BWF)
GIF (.GIF)	OGG Opus (.OPUS)	WAVPACK (.WV)
MIDI (.MID)	OGG Vorbis (.OGG, .MOGG)	WebM (.WebM)
MIDI Karaoke (.KAR)		WMV/WMA Video (.WMA, .WMV)

4.9 Importing REAPER Project Files

The media explorer allows you to either open an existing .RPP project on a new project tab, or to insert it into the currently active project.

In the latter case, REAPER renders the file through its master and inserts the rendered item into your project on a new track. You can insert the entire file, or whatever time selection you choose to make in the preview panel.

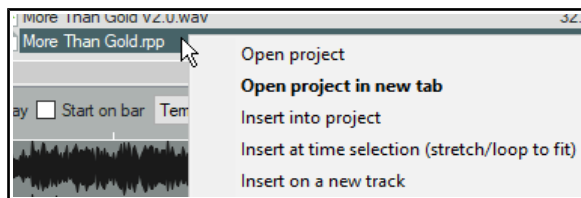

Unless you disable these options on the **Options** menu, when inserting the file REAPER will apply all relevant media explorer options, such as whether to tempo match and any pitch and/or play rate adjustments.

4.10 Previewing and Importing MIDI Files

A MIDI file selected in the Media Explorer can be played back either through a dedicated track named Media Explorer Preview, or through another selected track. In either case, the playback track will need a virtual instrument in its FX chain. To preview a MIDI file in media explorer and import it into a project:

1. Add a new track and insert a virtual instrument or synthesizer into that track's FX chain. If you wish, name the track Media Explorer Preview, otherwise you need to keep this track selected.
2. In media explorer, click the **Route** button and select **Play through first track named "Media Explorer Preview" or first selected track**.
3. Select any MIDI file in the media explorer and preview it in the normal way. If you wish, you can also select any part of a MIDI file before importing, by dragging within the displayed MIDI event preview.
4. Right-click over the file name or selected portion to choose one of the insert options, or just drag and drop. You can also import MIDI files by dragging and dropping from Windows Explorer, or use the **Insert, Media file...** command.

Unless you disable these options on the **Options** menu, any adjustments made to pitch in media explorer preview will cause the notes to be transposed when the file is imported into REAPER.

Managing Media: The Media Explorer

MIDI File Types

The two main types of MIDI file are Type 0 and Type 1. REAPER recognises both.

Type 1 MIDI

With Type 0, all MIDI events and data are stored in one track, but individual channel data is retained. A single track Type 0 MIDI file can contain up to 16 channels of data on the one track.

Type 1 files can contain any number of tracks, with each track containing data on one or more channels. Type 1 is more suited than Type 0 to larger arrangements.

When you import a type 1 multitrack MIDI file into REAPER, you are asked if you wish to **Expand the MIDI tracks to new REAPER tracks** and if you wish to **Import MIDI tempo map**. If you enable this option and click on **OK**, you will then be presented with options for **Multichannel items on a single track** or **Single channel items on multiple tracks**.

Type 0 MIDI

When you import the type 0 MIDI file into your project you are simply asked whether you wish to place a **Multichannel item on a single track** or **Single channel items on multiple tracks**.

4.11 Media Explorer Options and Other Actions

Here is a summary of the commands that appear on the Media Explorer **Options** menu. Many are self-explanatory: others are described in the main body of this chapter.

Command/Action	Options/Description
Default action (double click or Enter)	Insert media (on selected track, new track or sample player) or Open project (in current tab, new tab, or sample player), Start preview , Do nothing , or Attempt to open non-media files .
Search	Specify searchable fields: option to update search only when Enter is pressed.
When start on bar enabled, wait for next measure to start preview – self-explanatory.	
When selecting media ...	Auto-play selected media , Stop preview and display waveform peaks for selected media , or Continue preview of previously selected media .
Display preview in fractional seconds – self explanatory.	
Auto-advance to next file after preview (requires repeat off) – self-explanatory.	
Preview .RPP projects – toggle on/off: self explanatory.	
Do not auto-render REAPER.RPP proxy	Suppresses project tab preference.
Auto-stop preview when dragging media – self-explanatory.	
Auto-stop preview when inserting media – self-explanatory.	
Enable looping when inserting selected position of media – self-explanatory.	
Apply preview pitch/rate to inserted media item – self-explanatory.	
Apply preview volume to inserted media item – self explanatory.	
Normalize preview volume if peak volume has been calculated – self-explanatory	
Apply normalized volume to inserted media item – self-explanatory.	
Detect pitch (toolbar toggle button)	Detects pitch during preview, and displays it on the right hand side of the preview window.
Quick render part of media item in open project	Make time selection on timeline (above project). Select the media item, then Ctrl Alt Drag into media explorer main window.

Up and Running: A REAPER User Guide v 7.31

You might find that the Media Explorer menus provide all the functionality you need. However, there are actions available that provide further options. To access these, choose **Actions, Show actions list...** from REAPER's main menu, and select **Media Explorer** from the **Section** drop down list. The Actions List included all media explorer menu commands, plus many additional actions. Some prime examples are shown below, but this list is not comprehensive. These, and most other actions, can be assigned to shortcut keys or a toolbar, or added to the Media Explorer menu.

Category	Sample Actions List actions
Browser navigation	Go to next folder in history Go to previous folder in history Go to next shortcut in list Go to previous shortcut in list Go to parent folder Go to shortcut [1 thru 20]
Browser display options	Show all files / Show supported media only Clear all temporary marks Search: various actions to toggle search in metadata, various fields Reread metadata from media Use vertical layout (toggle) Actions to sort file list by specific columns(File Name, Date, etc.) Actions to load column order presets 1 to 10.
Loudness/peak volume calculate options	Calculate loudness stats for media dry run render Calculate peak volume and loudness (LUFS-I) for media/all media Calculate peak volume and loudness (LUFS-I) for media (force recalculation) (Displays results for selected items in Loudness column in Media Explorer window).
Preview actions	Automatically set temporary mark when previewing file Preview random file in current folder/database Display fractional seconds (toggle) Zoom to selection / Zoom out full Fast forward a little bit / Rewind a little bit Reverse preview playback / Play (cancel reverse playback) Set pitch to [+ or – 1 thru 12 semitones] Adjust pitch by [+ or – 1 cent or semitone] Reset preview pitch
Media/file/database management actions	Insert into project (loop disabled) Calculate peak volume for media Edit: rename file File: Delete options: no recycle / Recycle / Recycle, no confirm /Delete immediately – no recycle, no confirm Remove missing files from database/all databases Scan database for new files / Scan all databases for new files

More general information about the Actions List (including how to assign keyboard shortcuts) can be found in the [Customization](#) chapter of this user guide.

Project Arrangement Basics

5 Project Arrangement Basics

5.1 Managing Tracks

In Section 2, we introduced basic REAPER track management features, such as [Volume](#), [Panning](#), [Mute and Solo](#). This section will explore these features in more depth and introduce others, e.g. moving and removing tracks, track folders and track grouping.

Many of the relevant commands and actions are available from the menu that is displayed when you right click over any track number (see right). **Ctrl Z** can be used to undo your last action, as described in more detail in [Chapter 2](#).

PC or Mac?

Booster keys are used frequently throughout this User Guide. Booster keys on the macOS are not the same as they are in Windows (PC). This user guide references PC (Windows) booster keys. For OS users, please refer to the table in [Chapter 1, Selections, Controls and Commands](#) for a table of booster key equivalents.

Tip: Before continuing, you might wish to open the project file **All Through The Night.RPP** and save it to a new name, e.g. **All Through The Night EDITS.RPP**. You can use this file to experiment with some of the ideas presented in this section.

Basic Track Management

A number of techniques can be used for carrying out these various track management tasks.

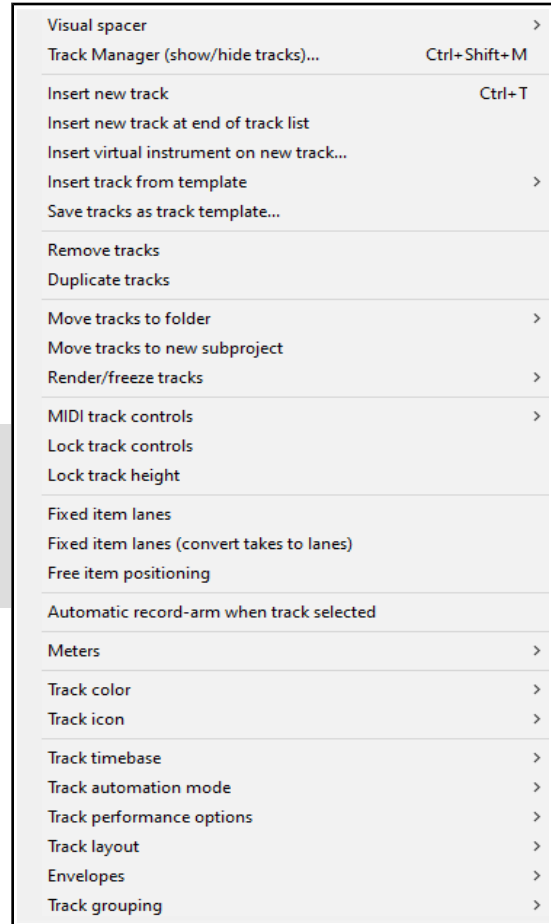

To do this ...	You should do this ...
Move a track up or down the track order	Click inside the track panel, then drag up or down the track list, releasing the mouse just inside the destination panel. Media items are moved with the track.
Move two or more adjacent tracks up or down	Click in first track panel as above, then hold Shift while clicking likewise on the track number(s) of the last track to be selected. Then click and drag up or down. Again. all media items are moved with the tracks.
Delete a track	Click on or around the track number, then press Delete , or right click and choose Remove tracks . All media items are removed with the track.
Delete two or more tracks	Use Ctrl click to make your selection, then press Delete , or right click and choose Remove tracks . Media items are removed with the tracks.
Copy a track as the next track	Right click on panel, choose Duplicate track . Media items are duplicated with the track. For several tracks, select all required tracks first.
Copy a track to a specified location	Click on the track number. Press Ctrl C . Move to the required location then press Ctrl V . All media items are duplicated with the tracks. To do this with more than one track, select all required tracks first.
Display the Master in Track View	Right click anywhere in the Track Control Panel area, below the last track. Choose Show master track , or use the keys Ctrl Alt M to toggle.
Make the Track Control Panel wider/narrower	Click and drag right/left on the boundary between the TCP and the arrange area. As the TCP becomes narrower, some controls may disappear from view and faders may change to knobs.

5.2 Track Control Modifiers

The **Volume, Pan, Mute** and **Solo** controls were introduced in [Chapter 2](#). As well as pan, a **Width** control will be shown if you select the stereo pan or dual pan mode - see [Chapter 11](#).

By default, volume and pan faders control audio output. To use them instead for MIDI data for any track(s), right-click over the track number and choose **MIDI track controls** then one of the **Link track volume/pan to MIDI** options from the menu (see [Chapter 13](#)).

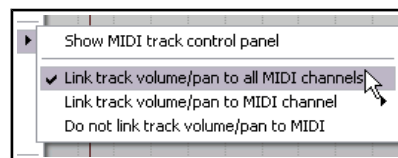

Volume and Pan Controls

Modifier Key	with Volume Fader or Pan Rotary
Alt	When mouse is released, fader returns to its original position.
Ctrl Shift	With more than one track selected, only the current track is affected.
Ctrl	Allows more precise control of fader level.
Double click	Reset to zero (fader) or center (rotary).

Mute and Solo Controls

Modifier Key	with Mute Button	with Solo Button
Shift	When more than one track is selected, only the current track is toggled.	When more than one track is selected, only the current track is toggled.
Ctrl	Clears all mutes.	Clears all solos.
Alt	Unmutes selected track(s), mutes others.	Solo selected tracks, excluding any sends.
Ctrl Alt	Mutes selected track(s), unmutes others.	Solo exclusive: Solos selected track(s), unsolos all others.
Ctrl Shift	Not applicable	Toggles <i>Solo Defeat</i> mode. The track(s) will still be heard even when another track or track selection is soloed exclusive.

Note: When a track is muted, a small red **M** icon is shown in its VU meter. A **!S** icon indicates that the track is not being heard because another track or tracks is or are soloed.



Solo vs Solo in place

Clicking a track's **solo** button engages **solo in place**: as well as the track, the output of any sends from that track (e.g. to a reverb bus) will also be heard. **Alt click** on the solo button of an already soloed track toggles between this state and plain **solo**, when only the track will be heard, without any sends.

The Mute and Solo control context menus

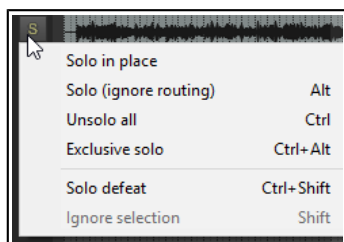

The options shown above are also available by right-clicking over the Mute and Solo buttons respectively. These context menus are shown on the right. They can be applied to an individual track or to a selection of tracks.

Bulk Track Mute/Solo

To mute or solo a range of tracks, click and drag in the TCP from the button of the first

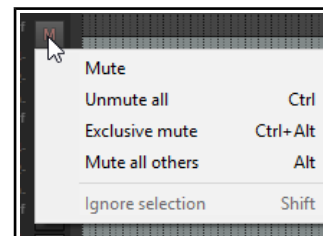

track to the same button on the last track, then release the mouse. Repeat this action to reverse this.

Track Control Panel Modifiers

By default, the following [mouse modifiers](#) can be used with the track control panel itself:

- Double-click** Select all media items on track.
- Shift double-click** Add all media items on track to selection.
- Ctrl double-click** Toggle selection of all media items on track.

Project Arrangement Basics

Sends and Receives

Right clicking over the volume fader of any track or folder will open a window displaying volume and pan faders not only for the track itself but also for any sends and receives associated with that track. An example is shown here.

Right clicking over the Pan fader opens a window which can be used to change that track's pan law. This subject was discussed in [Chapter 2](#).

Tip: By default, double-clicking on a track number in the track control panel will cause all media items in that track to be selected. You can change this behavior if you wish on the **Mouse Modifiers** page of your **Preferences**. For more information about customizing mouse modifiers, see [Chapter 15](#).

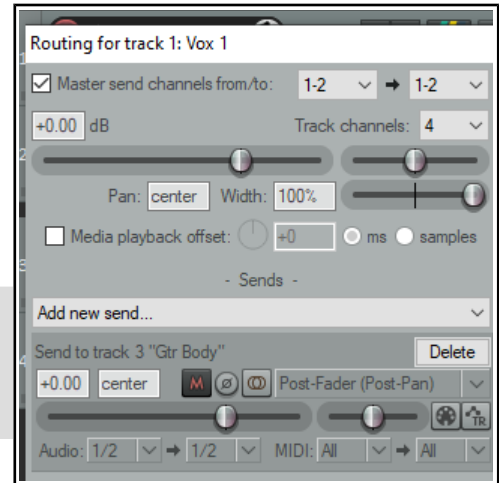

5.3 Mute/Solo In Front

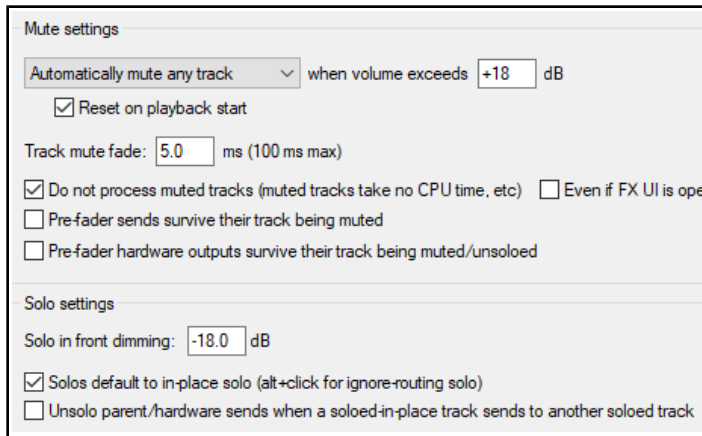

Mute settings include the option to automatically mute tracks when their volume exceeds a specified level.

Solo in front lets you to hear the other tracks quietly in the background when one track or a track selection is soloed. This is toggled on and off by the **Options, Solo In Front** command.

These options are set on the **Options, Preferences, Audio, Mute/Solo** settings page. This setting (in the example shown it is set at 18dB) determines by how much the background mix is *reduced*. This means that the higher the setting the quieter will be the background mix.

5.4 Auto-Naming Multiple Tracks

In one action you can create and automatically name any number of tracks, (either after the last touched track or at the end of the project) that serve a common purpose – for example, a number of backing vocal or percussion tracks. Use the **Insert, Multiple tracks...** command.

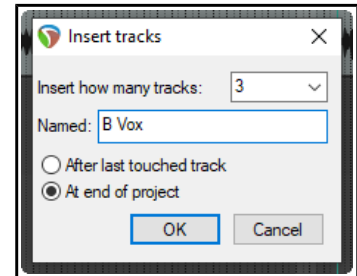

In this example shown, we are creating three Backing Vocals tracks at the end of the track list. These will be automatically named B Vox 1, B Vox 2 and B Vox 3.

5.5 Searching the Preferences Settings

You have already come across a number of REAPER's preferences settings. For example, we have looked at some of the preferences settings for Audio

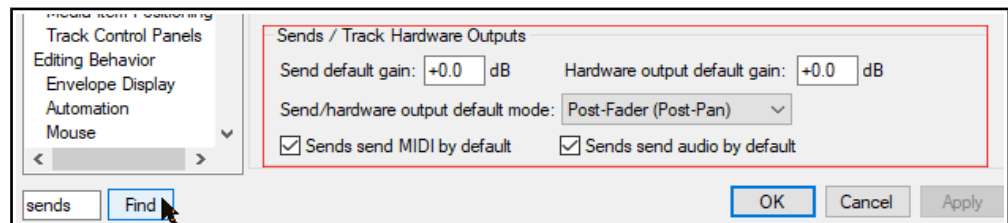

Devices, MIDI Devices, Recording and Projects. The more you work with REAPER, the more you will realise how

Up and Running: A REAPER User Guide v 7.31

very many preferences settings there are, so many that it can sometimes be difficult to remember where to go for a particular setting.

To help you there is a text box and a **Find** button near the bottom of the Preferences window. You can enter any word or phrase in the box, click on **Find** and the first occurrence of that word or phrase will be shown. Each time you click the **Find** button the next occurrence of that word or phrase will be shown. The item will be displayed with a colored highlight. In the example shown here, a search for **sends** has turned up some information about various options for setting the default parameters for track sends when they are created.

5.6 Track Colors

Windows users can also use the Windows color picker for making “on the fly” changes to track colors. To do this, simply select the track (or tracks) in the Track Control Panel, then right click, choose the **Track Color** command, then use any of these commands from the submenu.

Command	Effect
Set tracks to custom color...	Opens a Color Selector dialog for you to choose a color for the track panel and track media items.
Set tracks to random colors	Sets media items for each track in the selection to a different randomly chosen color.
Set tracks to one random color	Sets media items for all selected tracks to a randomly chosen color.
Set tracks to default color	Restores track color to the default for the current color theme.

5.7 Track Icons

To add icons to tracks you can drag your own .PNG or .JPG files from Windows Explorer and drop them on to any track control panel, or right click over the track number and choose **Track Icon** then **Set track icon...** from the track menu to use any of those supplied with REAPER. This opens the **Load Image Resource** dialog box. You can view the icons as thumbnails, tiles, or a list. Make your selection and click on **Open**.



Shown left is a project with track icons. Icons are saved with track templates. To display icons in the Mixer, choose **Show Track Icons in Mixer** from its context menu. To remove icons from any track or selection of tracks, first select the tracks (in either the TCP or MCP) then right-click over any track icon and choose **Remove Track Icon** from the menu. Additional track icon sets can be downloaded from the REAPER stash, at stash.reaper.fm

5.8 Track Meter Options

The track control panel and track meter context menus include track meter display options which can be applied to a single track, or to a track selection. See also [Master track options and settings](#):

Stereo peaks – separate loudness peaks for each channel.

Multichannel peaks – separate peaks for each of more than two channels.

Stereo RMS – individual root mean squared loudness of each stereo channel

Combined RMS – the combined RMS loudness of all audio channels

LUFS-M – Loudness Units Full Scale (momentary)

LUFS-S - Loudness Units Full Scale (short sampled), maximum or current

LUFS measures first two channels only

Display gain reduction for plug-ins that support it.

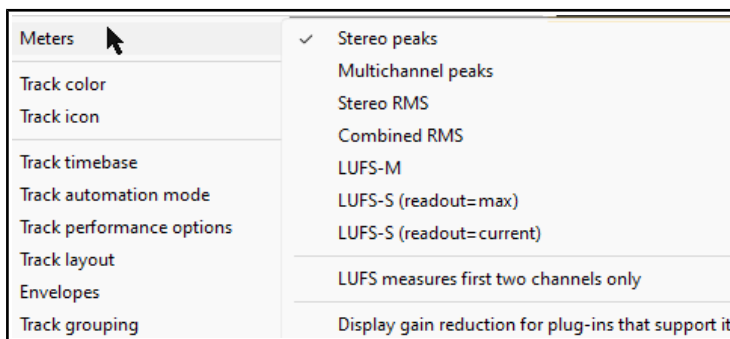

Your [Preferences](#), [Appearance](#), [Track Meter](#) settings includes various other options which help determine track meter behavior, including one for track meters to **display pre fader levels**.

Project Arrangement Basics

5.9 Track Layouts

The theme adjuster will be explained in Chapter 11. Meanwhile, in arrange view you can select and apply any of the default layouts available for the track panel, master track panel, mixer panel, master mixer panel, envelope panel or transport bar.

Any of the three layouts A, B or C as defined in the theme adjuster can be applied to selected track at either "normal" size, or larger (150% or 200%) or smaller (75% or 50%). Note that depending on your graphics card, some scaling options might not be available. To do this, simply:

1. Make your track selection in the Track Control Panel. Use **Ctrl A** to select all tracks in the project.
2. From REAPER's main menu, choose the command **Options, Layouts , Track Panel** to display a list of available options (see right).
3. Click on the option of your choice.

To restore the global default layout to a track or selection of tracks, choose **Global Layout Default** from this same menu.

To choose a layout from a different theme (e.g. REAPER 6), use the **Options, Themes** command to select a theme. Note that some **Track Layout** options might not be available.

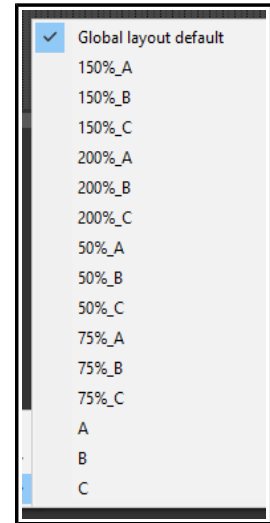

5.10 Displaying Grid Lines

REAPER offers a number of options for displaying grid lines. Grid settings and spacing are defined in the **Snap/grid settings** window: choose **Options, Snap grid, Snap/grid settings** from the main menu or press **Alt L**. Spacing options are shown above: other settings will be explained in the sections dealing with [Snapping with Snap/Grid Settings](#).

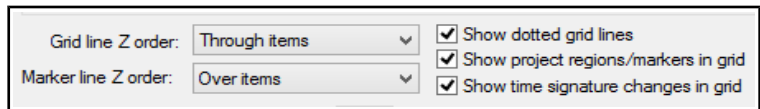
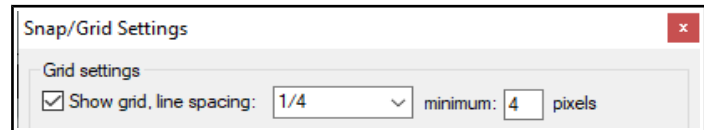

Grid lines are toggled on/off using the toolbar **Grid** button, or the **Options, Snap/grid, Show grid** command, or the shortcut **Alt G**. Grid line display options can be found in the [Appearance](#) page of your **Preferences** (above right).



Grid and marker lines can be displayed **over**, **thru**, or **under** media items in any permutation. In the example shown here, grid lines go under and marker lines over the media items.

You also have an option to set the grid line spacing to **frame** or **measure** rather than to a fraction of a beat.

Frame can be useful when working with video media. (**Frame rate** is set in Project Settings, see Chapter 2). If **measure** is selected, the grid setting will be determined by the time signature.

Later in this guide ([Chapter 7](#)), you will be shown how to use grid settings to automatically snap various objects and items into position.

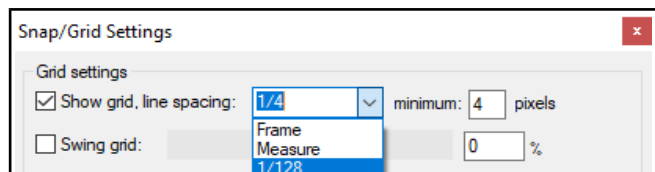

5.11 Headphone Monitoring and Headphone Mixing

Most would agree that when mixing it is better to use the monitors (speakers) in your studio or control room. However, you may wish also to use headphones from time to time, perhaps for those occasions when you need to focus in detail on a particular track or media item. Assuming that you have a PCI sound card or other audio device (Firewire or USB) which supports multiple outputs, here's a neat little trick.

1. Assign **Output Aliases** to your outputs, as explained in Chapter 1.
2. Display the Routing Matrix. Assign the output from the Master to the Control Room speakers.
3. Put on your headphones.

- As you play the song, click on the appropriate cells on the routing matrix to also direct any particular track on which you wish to focus to your headphones. You can change from track to track, or add as many or as few as you want at any time.

In the example above, the entire mix (from the Master) is being heard through the Main Speakers, but only track **1 Vox** is also being heard through the headphones.

Remember you can right click over this grid cell to display the controls for this send (such as Volume). This can be useful when a musician who wants to particularly hear only some tracks when recording.

When you are mixing down, you might not wish to see all of the available routing information available – it can get quite complex. You might wish to keep the routing matrix display as simple as possible for the job in hand. For example, if you are focussed purely on mixing, you might not need to see all the various input assignments.

Right clicking over the background area lets you customize its display. In the example shown here, by unchecking **Show audio hardware as sources** we have simplified the display. If you have installed ReaRoute, consider also disabling the options to **Show ReaRoute as destinations** and **Show ReaRoute as sources**.

Creating a Headphone Mix

Provided your sound card includes at least two pairs of outputs, we can make the process of headphone monitoring easier and more flexible by creating a headphone mix. This is how it is done.

- Connect your Headphones to your Headphone Amp. Assign the Headphone Amp to one pair of outputs.
- Create a new track and name it **Headphone Mix**.
- Create sends to this track for any and all tracks that you want to be able to monitor thru your headphone mix. If you wish to include all tracks in the headhone mix, open that track's routing window, and choose **Add receives from all tracks** from the receives drop down list.
- Choose the **Options, Preferences** command, select the heading **General** then click on the **Advanced UI/System tweaks ...** button. Enable **Allow track envelope/routing windows to stay open**.
- Click **OK** then **OK** again to close the Preferences window.
- Select your **Headphone Mix** track. Open the **Routing Window**. Add an **Audio Hardware Output** to the paired outputs connected to your Headphone Amp. Disable the **Master/Parent Send** for this track.
- You can now use the Pan and Volume faders for your receives, together with the Mute buttons, to control your headphone mix.

5.12 Understanding Sends, Buses, Submixes and Folders

You have already seen that each of the tracks in your projects has its audio output routed by default to the master, and that from here the audio signal is directed to your preferred output device or devices, such as speakers or headphones. The signal flow that occurs here within REAPER can be represented by the first diagram on the right, which shows a simple project with just three tracks.

In Chapter 2 you were shown [how to use a track as an effects bus](#), for example to add the same reverb effect to a number of tracks. The signal flow for this arrangement can be represented by the second flow chart (below right).

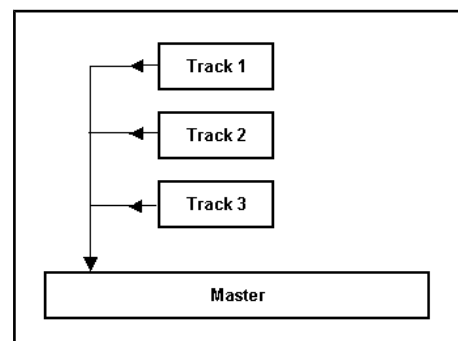
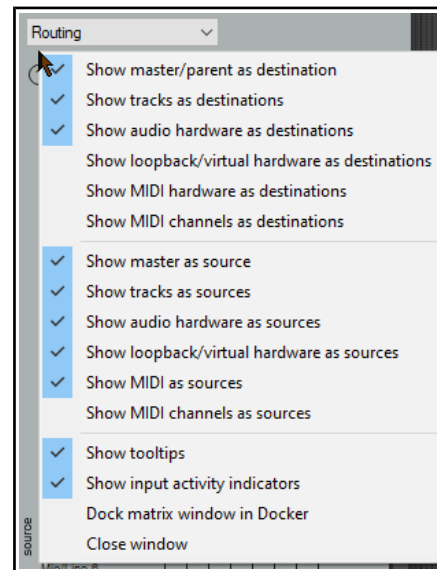
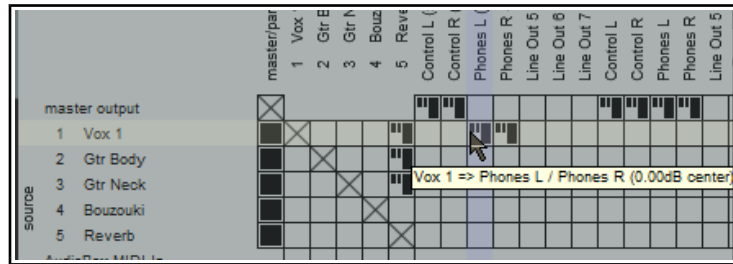

Project Arrangement Basics

Each track's send carries a signal to the bus track which applies the effect, and then sends the processed (wet) signal on to the Master. As long as the **Send Master/Parent** option remains enabled, the dry signal for each track is also sent directly to the master. Here it is finally mixed together with the "wet" signal from the bus before being directed to your speakers and/or headphones.

These two examples use routing arrangements that you would find in most DAW programs. However, we are now about to enter territory where REAPER may be substantially different from other software that you may have used before. This concerns how you can create and use submixes.

With most programs, to create a submix (perhaps for drum tracks or vocal harmonies) you will need to create a bus, add sends from each track that is to be included in the submix, and then disable the direct sends to the master from each of these tracks.



You can use this method in REAPER. Holding **Alt** while clicking on a track's **ROUTE** button toggles on and off the direct send to the master. If output to the master is enabled the first of the stripes on the ROUTE button is colored.

If disabled, it is gray. This distinction is shown here. In the first track, the output from the track to the master is enabled, in the second track, it has been disabled.

However, a smarter and potentially more powerful way of creating a submix is to use folders (sometimes called track folders). We'll look at how this is done shortly.

A folder track is created initially in the same way as any other track. You then tell REAPER to treat this as a folder track - and essentially that's it. You now have your submix (as shown here on the right). Direct output to the master from the individual "child" tracks within the folder is automatically disabled. Instead, they are passed thru the folder. You should not manually disable the master/parent send for child tracks within a folder, or their output will no longer go to the folder track.

Anything that you do to the folder will be done to the entire submix. For example, if you adjust the volume up or down, the volume of the submix will be adjusted up or down. If you add an effect such as a compressor to the folder then that effect will be applied to the submix.

Before we see exactly how a folder and its child tracks are set up, there's one more scenario to consider. Even when you have a folder which contains a submix of other tracks, you can still use buses for the folder itself or for individual tracks inside the folder (see right). In this case our folder (submix) still consists of the same three tracks as before. In addition, however, a send has been created from the folder to an FX bus, perhaps to add reverb to the submix. We'll see an example of this soon.

There are three types of send – **Post-Fader (Post Pan)**, **Pre-Fader (Post FX)** and **Pre FX**. These are explained in Chapter 17 and illustrated by the [flow charts at the end of Chapter 6](#). For the time being, accept the default option, **Post-Fader (Post Pan)**.

5.13 Track Folder Essentials

When a number of tracks are collected into a folder, you will probably want to use both the individual track controls and the folder controls. For example, you can use the **Volume** controls for individual tracks within a folder to set the volume levels for the different tracks relative to each other. You can then use the Volume control for the folder itself to control the overall combined volume level of the tracks in that folder. In fact, you can use all of the folder track controls (mute, solo, etc.) to manage tracks within the folder.

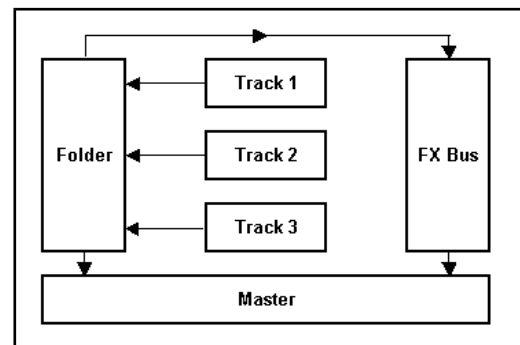
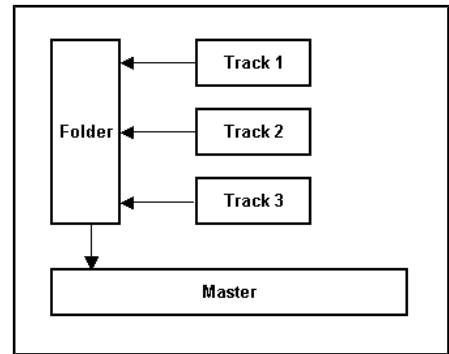
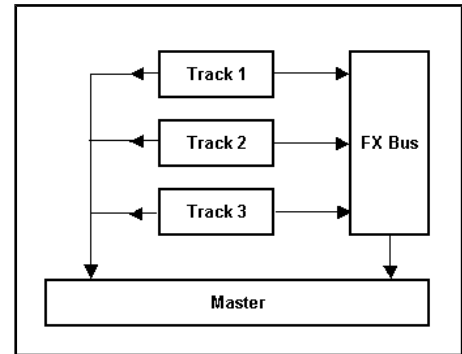

Up and Running: A REAPER User Guide v 7.31

The example shown (below right) shows that a folder called **Guitars** has been added to our **All Through the Night** project. This folder contains the two guitar tracks. The faint peaks that you will see in the folder's lane in arrange view represent the combined contents of the folder's child tracks.

This can be disabled on your **Preferences, Appearance, Peaks/Waveforms** page. Identify the little icons that you can see below the track number of each item in the track control panel.

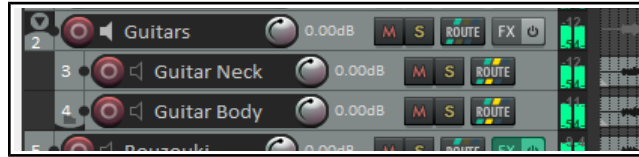

These are used to determine a track's folder status. Identify each of these three states:

- An ordinary top level track (the default). The icon shows a faint image of a folder. Hover the mouse over this image and it changes to a + sign.
- A folder track. This is displayed as in the Guitars track above, as a stronger image of a folder. Hover the mouse over this image for a tooltip (above right).
- The last track in a folder. A folder icon is shown and the track is nested. Hover over this icon and it displays a tooltip (right).

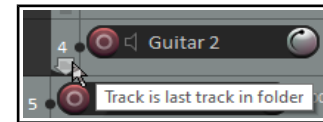
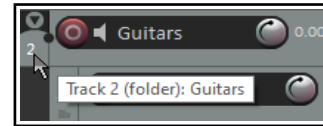

If you need to restore a folder to being a normal track, click on the folder control icon as many or as few times as are required to cycle thru the various options until you see the one that you want.

You can click on this icon to set a track's status. Let's look at an example.

Example (Optional)

Open the file **All Through The Night** and save it as **All Through the Night FOLDER**.

Select track 1 and press **Ctrl T** to add a track below this, as track 2. Name this track **Guitars**. Click on the track's + button once to make this track a folder. Click on the Gtr Neck track's + button twice to make it the last track in the folder. Save the file.

Note: For child tracks enclosed within a folder – as in the above example – the parent will be not the master but the folder track. Their output will by default be directed to the parent (folder) track (where, for example, FX can be applied) and from the folder track to the master.

5.13.1 Drag and Drop Folder Management

Another way of creating folders is by dragging and dropping. You identify which track is to be the folder, which are to be its children, then select and drag and drop the children into the folder.

This method can be tricky unless you are precise in your mouse movements. You might recall that in **Section**

2.28 Managing Tracks we saw that dragging and dropping track panels up or down the track display can move them and park them in a new position. This time, however, that's not what we want.

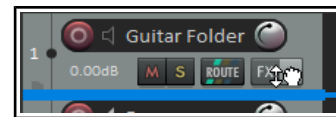
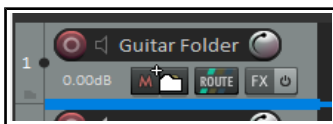

The trick is to drop the tracks inside the zone used for creating folders. The exact area and size of this drop zone will vary with track height and track width: as a guide, think of it as occupying roughly the vertical middle of the track panel. You'll know when you're there because the mouse cursor will display a folder (as shown above left) rather than a hand (as shown above right). Here's an example.



Tracks 3 and 4 have been selected and are to be to be dragged up to Track 1, which is to be their folder container track.

As they are dragged up, shown left the mouse displays a hand because the cursor is too far below the vertical center. This would just move the tracks up the order but would not place them in a folder. We need to be in the drop zone, closer to the center, as shown in the second picture (above right). Notice the mouse cursor is now shown as a folder.



Project Arrangement Basics

From this position we release the mouse, and the two guitar tracks are now placed inside a new folder, with Track 1 as the containing folder track (as shown below).

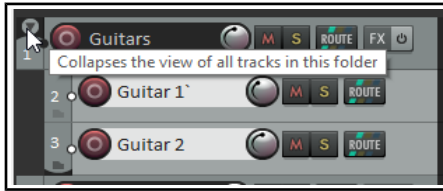

Note: You can start your drag and drop from any part of the track panel (apart, of course, from the controls themselves), but to place the tracks into a folder you must move the mouse cursor to the folder drop zone before releasing it.

Notice the small down pointing arrow just above the track number of the folder track (in this case Track 1). By default, this can be used to toggle the display of child tracks in the folder between **normal** (as shown by default), **minimized** and **collapsed**.

Shown below is the same folder with its child tracks collapsed.



In **Preferences, Appearance, Track Control Panel** there is an option to include **hidden** in the cycle options (see right). This allows you to hide child tracks altogether.

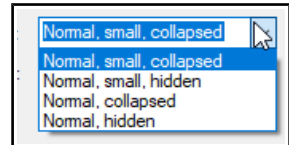

If you prefer not to use the above method for drag and drop there are other options available. You can go to **Options, Preferences, Editing Behavior, Mouse** and select one of the three other options available, including holding **Shift** while you drag and drop.

Simple drag and drop will still move tracks: holding **Shift** while doing so will create a folder and place adjacent tracks into it without any need to find the folder drop zone.

5.13.2 Context Menu Folder Options

Another option for moving tracks into folders can be found on the track panel context menu. The panel's context menu includes a **Move to folder** command that will place a selection of tracks into a new or existing folder.

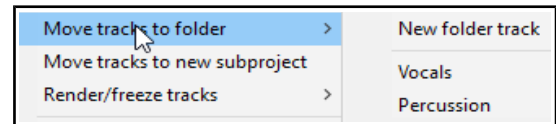

First, select the tracks that you wish to move into a folder, then from the right click context menu choose **Move tracks to folder**. You can then select from the list of existing folders or choose **New folder track** to insert the tracks into a new as yet unnamed folder, immediately above the first track in the selection.

You can then name the folder track by double-clicking in its name area.

5.13.3 Routing Matrix Display

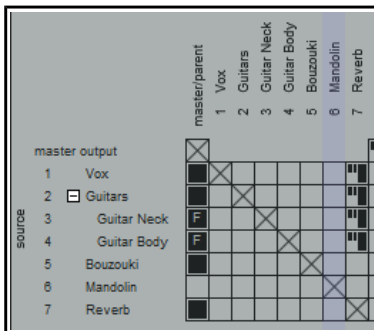

Notice how folders and their child tracks (as well as any track colors) are displayed when you view the routing matrix. Child track names are indented within the folder tracks names, and the square box beside the folder name can be used to hide or display child tracks in the matrix, as required.

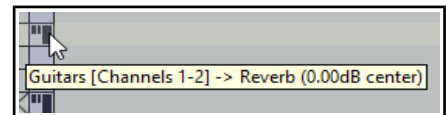

The letter F in the first column indicates that the track is contained within a folder. In the example shown, the one folder contains two child tracks.

Note also that hovering the mouse over any send graphic will display a tooltip with information about that send (above right).

5.13.4 Hidden Child Tracks

The [Actions List](#) includes an action **Track, Move all media items to new hidden child track**. As its wording implies, this will convert a selected track into a folder and move all media items currently on that track to a new child track within that folder. Note that:

- ◆ The child track itself will be hidden, although its waveforms and peaks will be "ghosted" on the folder track.
- ◆ Hidden tracks can be displayed by clicking in the TCP column in the [Track Manager](#).
- ◆ All settings on the original track (e.g. volume, pan, FX chain) will remain on what is now the folder track.

This process can be reversed by selecting the folder track and running the action **Track: Move all media items from all hidden child tracks**.

Up and Running: A REAPER User Guide v 7.31

5.13.5 Nested Folders

REAPER allows you to nest folders within folders, to as many levels as you like. This feature is probably more suited to relatively experienced DAW users than it is to newcomers.

To create a nested folder, first create an empty track within an existing top level folder, then use the folder control icon to make that track into a folder. Because the track is itself contained within an existing top level folder, it will automatically be made into a second level folder. Shown here is an example. Notice that:

- There is a top level folder called Instruments which holds two sub-folders (Guitars and Percussion).
- Both second level folders contain child tracks.

Any action taken on a folder will effect its entire contents. For example, if in this case you were to mute the Instruments folder, then the Guitars and Percussion folders and their child tracks would also be muted.

REAPER does not limit you two levels of folders. You can have more if you like.



5.14 Track and Track Parameter Grouping

Note: As well as conventional grouping, REAPER supports VCA (Voltage Controlled Amplifier) grouping. To help avoid confusion, VCA grouping will be considered as a separate topic later in this chapter.

By using track and parameter grouping you are able to define relationships between different tracks and their controls so that when you make a change to one control in the group, changes are also made to other tracks. The nature of these relationships can vary from being quite simple to rather complex. Here are some examples.

- You might have two tracks that you wish to keep at a constant volume relative to each other. In this case, you could ensure that whenever one is faded up or down then so is the other.
- You might have two tracks that need to be panned opposite each other. In this case, you can ensure that when one is panned in one direction, the other is automatically panned in the other.
- You might have two or more tracks that you wish to be always soloed or muted together.

In a moment, we'll work thru some examples. There are two main ways to create and manage your groups. This can be done either using the **Track Control Panel** or the **Track Grouping Matrix**. Here is an overview of both methods.

Method 1 uses the Grouping dialog box (shown right), which can be accessed from the Track Control Panel, the Mixer Control Panel:

- In the TCP or MCP, select the tracks whose parameters you wish to group. Right-click over any track number in the group and choose **Track grouping** then **Track grouping parameters** from the menu (or press **Shift G**).
- When the Grouping window is displayed (see right) specify those parameters that you want to group. Optionally, you can change the group name from its default, which will be Group 1, Group 2, etc. Click on **Close** when finished.
- Make sure that the option **Track grouping enabled** on the TCP or MCP menu is selected (ticked).

You can use this same method later to make changes to your grouped parameter definitions.

This interface might appear strange at first. For this reason, it may be easier, especially at first, to use the second method. Method 2 uses the **Track Grouping Matrix**.

The track grouping matrix, which can be docked, can manage up to 128 groups. To display this, choose the **View, Track Grouping**

Matrix command, or press **Ctrl Alt G**. We can create a special project file for our examples. You can then group

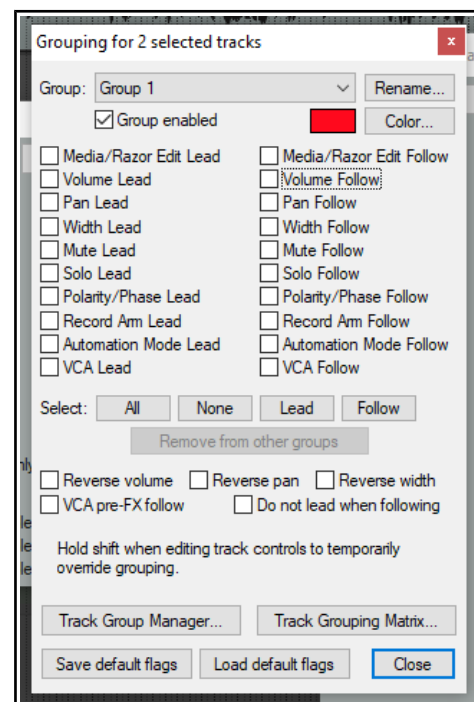

Project Arrangement Basics

any selection of tracks that you like: in this example, we will be working with the two guitar tracks enclosed within the track folder. Note that you do not need to place tracks in a folder in order to be able to group them. First, you should note that track grouping globally is turned on and off using the **Track, Track grouping enabled** command. When this is ticked, grouping is enabled. This command can be used to temporarily disable track grouping without the need for you to redefine or modify your groups.

5.14.1 Basic Track Grouping

Example

Open the sample file **All Through The Night FOLDER**. Save it as **All Through The Night GROUPS1**. Use the **View, Grouping Matrix** command to display the matrix..

Each column except the first represents a control that can be grouped - volume, pan, mute, solo, etc. Each row represents a project track. Clicking inside the grid defines the tracks and parameters to be linked. In this example:

- The volume controls of the two guitar tracks are linked. Raising or lowering either volume control will automatically do the same to the other.
- The mute controls are linked. Muting either guitar track will automatically mute both.
- The pan controls are also linked – but note that for one of these tracks the pan reverse option is also enabled. This ensures that when one of these is panned, the other is be panned in the opposite direction!

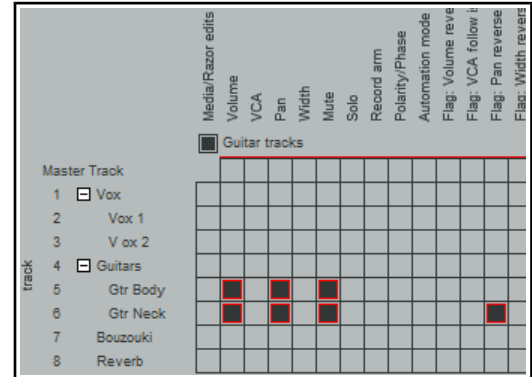

Notes:

1. The TCP shows colored ribbons for grouped parameters (see right). The **Appearance, Track Control Panel** preferences page includes an option to change this to edge lines or none.

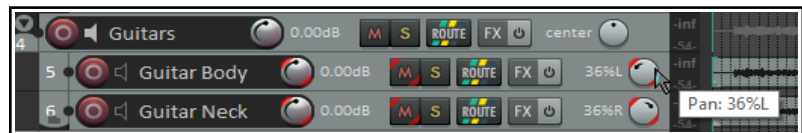

- To temporarily over-ride the grouping, hold **Shift** while adjusting the parameter of any one group member.
- You can right click on any track name in the matrix to open the track grouping window for that track.
- Notice the first Grouping Matrix column, headed **Media/Razor Edits**. This is a more complex topic and deals with matters such as the group editing of media items within a track group or across several groups. This will be [explained in Chapter 7, Managing and Editing Media Items](#). The **Track Group Manager**, accessed by a button located above the matrix, will also be discussed and explained in that context.

5.14.2 Track Grouping Matrix Basic Controls

In order to do this ...	Using the Track Grouping Matrix
Display Help window	Click on the ? Button (top left corner of window).
Define the tracks in a new group	Display the Track Grouping Matrix. Select at least one parameter (such as Pan) for each track in the group.
Adjust all linked faders for a group	In Mixer or Track Arrange view, adjust the fader for any one track in the group.
Adjust the fader for only one track in a group containing linked faders	In Mixer or Track Arrange view, hold Shift while adjusting the single fader.
Define a pan or volume relationship as reverse for a track within a group	In the track row, click on the intersection cell for Pan Reverse or Volume Reverse .
Change an existing toggle parameter relationship (such as Solo, Mute or Record Arm) into a reverse one	In Mixer view, hold Shift while clicking on the appropriate button (such as Solo or Mute) for the individual track. Use Shift again to restore the positive relationship.
Display grouping window settings for an individual track	Right click over the track name in the track grouping matrix.

For a bound hard copy of the latest version of this User Guide (printed in B&W) go to LULU.com

Up and Running: A REAPER User Guide v 7.31

In order to do this ...	Using the Track Grouping Matrix
Link more parameters for tracks in an existing group	Click on the intersection cells where the required parameter column meets the track rows.
Add another track to an existing group	Click on intersection cell where the required parameter column meets the row for the track that is being added.
Remove a track from an existing group	Click once, twice or three times on the appropriate intersection cell until it shows blank. If more than one parameter is linked, do this for each parameter.
Enable/Disable group	Click in the group's Enable/Disable box.
Select all tracks in a group	Click on the group name.
Ensure automation mode of follow tracks automatically follows that of lead	Use the Automation Mode column of for tracks in the group.
Fine tune behavior of groups which share common tracks.	Use the Flag: Do not lead when following settings to ensure, for example, that a track which is a lead in group 1 and a follow in group 2 will not act as a lead in group 1 when being a follow in group 2.

Note: By default, all 64 possible groups are enabled. If this leads to screen clutter, consider disabling those that you are not using by unchecking the box shown here.

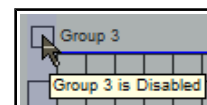

5.14.3 Lead and Follow Group Relationships

Each parameter that is included in a grouped relationship can take one of three states – Lead/Follow (the default), Lead only, or Follow only. The different ways in which this affects that parameter's behavior are:

- A Lead/Follow item can control other Lead/Follow and Follow only items, but not Lead only items. It can itself be controlled by other Lead/Follow and Lead only items. This is the default type, indicated in the matrix by solid black.
- A Lead only item can control other Lead/Follow and Follow only items, but not Lead only items. It cannot be controlled by any other item. This is represented in the matrix by the letter L.
- A Follow only item cannot control any other item, but can itself be controlled by Lead/Follow items and Lead only items. This is represented in the matrix by the letter F.

In the previous exercise, all items within our group had Lead/Follow status. This meant, for example, that when you adjusted the panning or the volume on either of the two guitar tracks, the equivalent parameter on the other guitar track would move according to the defined relationship. This happened regardless of which of the two tracks you used to make the adjustment. Let's now look at some different scenarios.

Example

This example illustrates a relatively simple case of how track parameters can be flexibly linked. Again, use the file **All Through The Night GROUPS1**.

The Guitars folder and the Bouzouki track solo controls have been linked, Guitar as lead, the Bouzouki as follow.

Click twice on the Guitars/Solo cell to set it to lead, three times on the Bouzouki/Solo to set it to follow only. A fourth click would clear the cell altogether.

You will now find that if you solo the Guitars folder, the Bouzouki track will also be soloed.

If you unsolo this and then solo the Bouzouki track, however, you will hear only the Bouzouki track.

Save the file as **All Through The Night GROUPS 1A**.

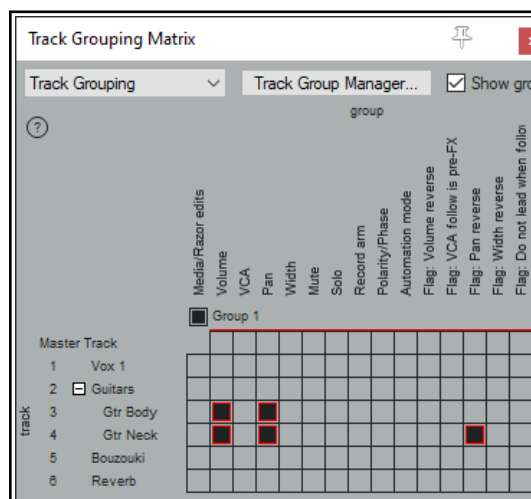

Project Arrangement Basics

5.14.4 Track Grouping Window

The Track Grouping window displays all group information about the various parameters for any selected track or selection of tracks. Most commonly (and most usefully) it makes sense to use it with individual tracks, one track at a time. Again, this will be more readily understood if you work thru an example.

Example

Open the project file **All Through The Night GROUPS1A.RPP**. Select the **Gtr Neck** track in the TCP. Either right-click over the track number and choose **Track Grouping Parameters ...** from the context menu, or press **Shift G**. This causes the Grouping window for the selected track to be displayed (see below left).

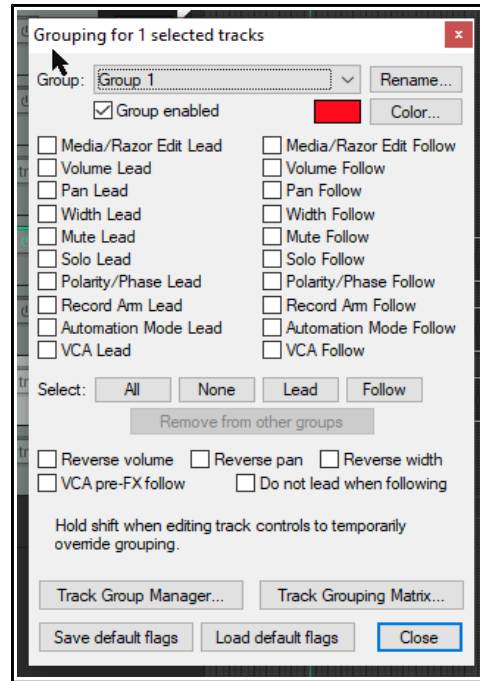
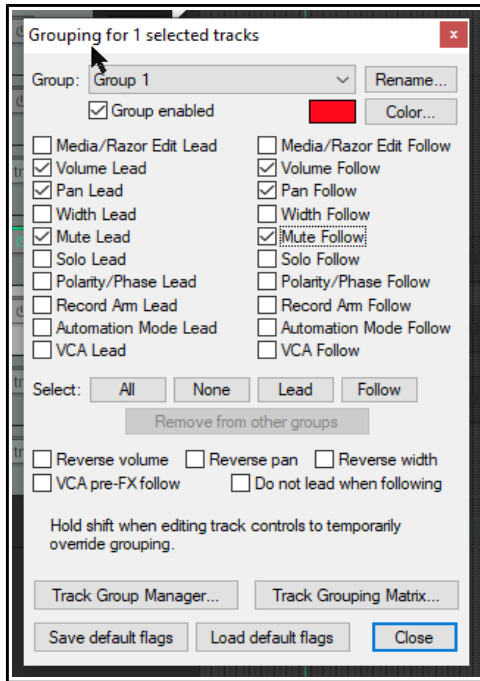

In the TCP, select the Bouzouki track. The display in the Grouping window changes (above right), to show the currently grouped parameters for the bouzouki. In this dialog box, click and select **Mute Lead**. This is confirmed by the display in the track grouping matrix.

You can define up to 128 groups in a project file. The [actions list](#) includes actions to select all tracks in any of these groups. In the example below, a second group has been added, to help when adjusting the balance between the volume of the vocal track and the various instruments.

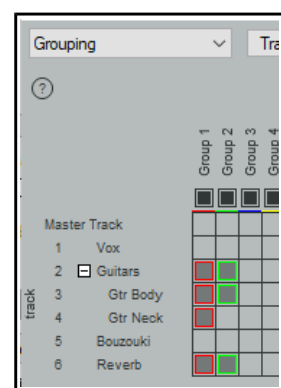
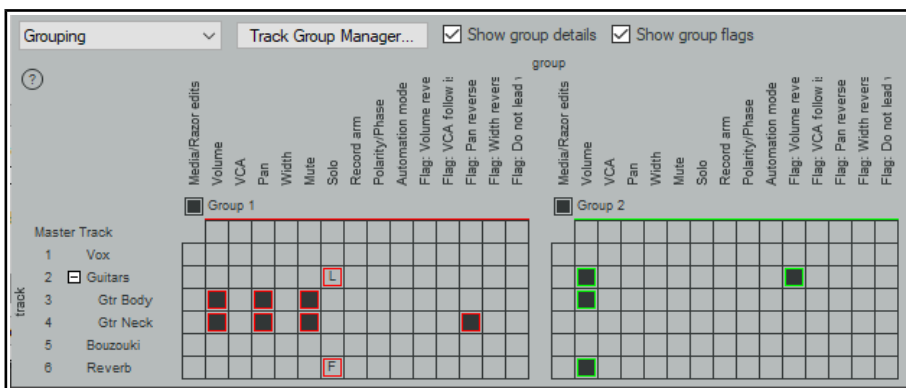

Note: The first of the two check boxes above the matrix allows you to toggle on (above left) or off (right) the option to **Show group details**. The second allows you to show or hide the **Group flags** columns.

Up and Running: A REAPER User Guide v 7.31

5.14.5 Track Grouping Window Basic Controls

In order to do this ...	Using the Track Control Panel
Define the tracks in a new group	Select the tracks in the Track Control Panel, press Shift G then select at least one parameter.
Name a group	Press Shift G , select the required group number and click on Rename .
Adjust all linked faders for a group	Adjust the fader for any one track in the group.
Adjust the fader for only one track in a group containing linked faders	Hold Shift while adjusting the single fader.
Define a pan or volume relationship as reverse for a track within a group	Select track in the TCP and press Shift G . Click on Reverse Volume or Reverse Pan as required.
Change an existing toggle parameter relationship (such as Solo, Mute or Record Arm) into a reverse one	Hold Shift while clicking on the appropriate button (such as Solo or Mute) for the individual track.
Link more parameters for tracks in an existing group	Open the Grouping dialog box for the group and select the required parameters.
Reset a track's volume, pan or width to its default value and adjust settings for other group members accordingly	Double-click on the volume, pan or width value displayed in the track panel.
Add another track to an existing group	Select the track in the Track Control Panel and press Shift G . Display the drop down group list and select the required group. Select the required parameters.
Remove a track from an existing group	Select the track in the TCP and press Shift G Unselect all selected items except Group enabled
Enable/Disable group	Press Shift G , select the group from the drop down list then click in the Group enabled box.

Tip: When playing back a song, you may from time to time wish to reset your VU Peaks without needing to stop and restart playback. To clear one peak, simply click on the peak number shown at the right hand end of the VU meter in the TCP or top of the VU in the MCP. To clear all peaks, hold down the **Control** key while you do this.

5.15 Temporary Track Grouping without the Grouping Matrix

You can make any selection you wish of any number of tracks (in the TCP or MCP), and as long as they all remain selected you can operate their track controls as a temporary group. All will act as Lead/Follow.

In order to do this ...	Do this ...
Define and link any number of contiguous tracks in a temporary group	Click in TCP of first track to be selected. Shift-click on last track to be included in the selection.
Define and link any number of non contiguous tracks in a temporary group	Click in TCP on first track to be selected. Ctrl click one by one on each other track to be included in the selection.
Adjust a TCP control for all tracks in temporary group (e.g. Volume, Mute)	Adjust fader or rotary (Volume, Pan) or just click (e.g. Mute, Solo) for any one track in the group.
Adjust control for only one track without deselecting the group	Hold Shift while you adjust fader or rotary (Volume, Pan) or just click (e.g. Mute, Solo) for any one track in the group.
Unlink and ungroup tracks in a temporary group	Click in TCP of any one track.

Project Arrangement Basics

5.16 VCA Grouping

The origins of VCAs (Voltage Controlled Amplifiers) predate digital audio. By way of analogy, VCAs in REAPER are a form of track grouping which allows tracks to be followers within a group to a single track lead. VCA follow tracks will have their volume dBs added to that of the VCA lead track: thus, with VCA grouping the process is additive. With conventional grouping, (such as in section 5.16) nothing is added, the tracks are simply linked.

VCA groups can be set up and managed using the same track grouping matrix as in 5.16. In this section we will keep to simple examples, to help you understand the VCA concept. The basic procedure for creating a VCA group is:

1. Add a new track at the end of your project and give it a suitable name, such as VCA Control. Ordinarily, this track should contain no media items.
2. Display the track grouping matrix for this track and select a currently unused group. Name this group VCA.
3. Set the VCA status in this group for your VCA Control track to L (for lead).
4. Set the VCA status in this group for any tracks that you want it to control to F (for Follow).

Example

Open the file **All Through The Night.RPP** and save it as **All Through The Night VCA.RPP**.

Pan the first guitar track 35% left and the other 35% right. Add a new track (Track 5) and name it **VCA Control**.

Display the track grouping matrix (**Ctrl Alt G**). Make sure that the other tracks are in the same order as shown here, below right.

Right-click over the text **Group "n"** to open the Grouping dialog box (above). Click the **Rename** button, then type **VCA**, then on **OK**, then **Close** the dialog box.

Set up this group as shown (right), so that track 5 is your VCA lead track and tracks 2, 3 and 4 are VCA follow tracks.

Play the song. As you raise the volume fader on the VCA control track, the three instrument tracks will each become louder. As you turn down the volume on track 5, the instruments will become quieter.

Notice that the VU meter levels on the follow instrument tracks will change. The adjusted volume of these tracks (added to that of any audio produced by any items in VCA control track itself) is sent to the lead. Thus, the lead's VU meter levels change as the VCA control track fader is adjusted.

Now let's try something different. Make sure that the pan law for all tracks is set to **Stereo balance/mono pan**. This is done by right clicking over the track's pan control and selecting from the pan law drop down list.

Click on the Bouzouki/VCA matrix cell to remove it from the group. Now play the song again. As you do so, adjust the pan setting on the VCA control track. You will find that the panning of the three instrument tracks will each be adjusted accordingly. Save the file.

VCA Grouping Parameters

This table summarizes the VCA track grouping matrix options and parameters:

Parameter	Comment
Volume	Adjust the volume fader on the VCA lead to adjust the volume of all follow tracks in the VCA group. Note that the follow track faders themselves will not be moved.
Pan	Provided either Stereo balance/mono pan or Stereo pan has been selected as the pan law, changing the panning on the VCA lead will cause the panning of all follow tracks in the group to be changed. The pan faders on the follow tracks, however will not be moved.

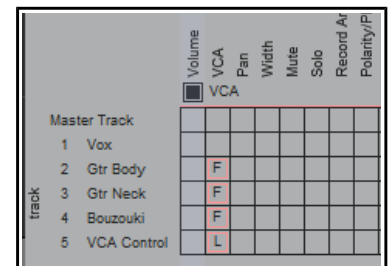
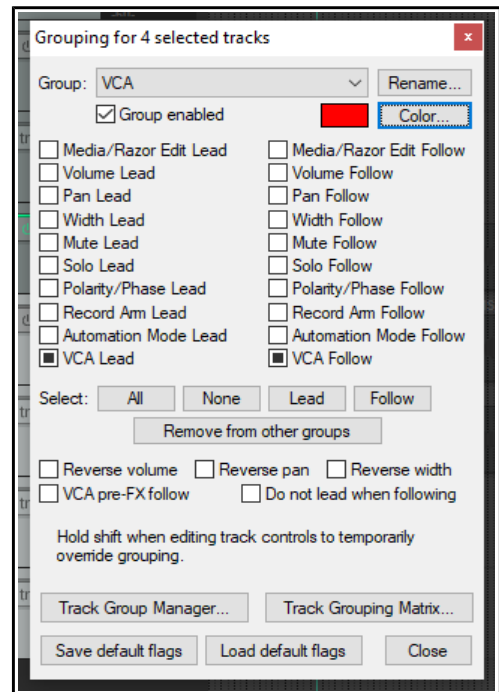

Up and Running: A REAPER User Guide v 7.31

Parameter	Comment
Pre FX Follow	If the track grouping matrix option Flag: VCA pre-FX follow is selected for any VCA follow track, then the signal volume will be adjusted before it is fed into the that track's FX chain.
Automation	Volume, pan and width changes on follow tracks can be automated by adding envelopes to the VCA control track. The envelopes will be applied to all follow tracks in the group. Follow tracks may also have their own automation envelopes. Chapter 18 includes more about envelopes.
Mute	A mute envelope can be added to the VCA lead. This envelope will be applied to all VCA follow tracks in the group. Automation envelopes are explained in Chapter 18.

Note: Defining a track as a VCA lead causes that track's volume and pan faders to control volume and panning on all of its follow tracks. Keep in mind that a VCA control track is *not* a track folder or submix. No audio passes thru a VCA lead/control track. It would make no sense to add audio FX directly to a VCA control track.

VCA with Automation Envelopes

You will need to understand something about automation envelopes if you are to understand this section. Automation envelopes are explained in [Chapter 18](#).

Conventional automation does not work well with ordinary groups. For example, a volume or pan envelope on a group lead track will, on playback, adjust the volume or pan settings on that one track only, not on its follows.

With VCA grouping, however, an envelope on a VCA control track will be applied to the summed total of its follow tracks.

You can have separate automation envelopes on both the VCA lead and any of the follow tracks within the group. Shown here is the same project as in the previous example, with the same groups as before, and with volume envelopes added to the VCA control track and one of the follow tracks (Bouzouki). The summed levels of both follow and lead envelopes will, on playback, be sent to the lead.



VCA with Overlapping Groups

Conventional grouping does not fully allow for overlapping group membership. For example, tracks 1 to 3 volume faders could be grouped as leads and follows in one group, tracks 4 to 6 in a second group, but you could not have another group to control volume faders on, say, tracks 1 and 6 only.

VCA grouping makes this possible. You could create two ordinary groups – one each for volume control on tracks 1 to 3 and 4 to 6. You could then create a VCA group (Lead) to control volume on tracks 1 and 6 only (Follows).

Chaining: this is when a track is a VCA lead in one group and a follow in another VCA group.

Tip: Pressing **Alt Shift G** will toggle on and off item and track media grouping. This can be useful if you want to temporarily disable track grouping, then later re-enable it. **anaging Groups from the Track Panel.**

5.17 Track Group Management from the Track Panel

The **Track Grouping** command on the track panel context menu provides several options for managing track grouping,

First select the panels of the tracks that you wish to group, then display this menu and choose **Track grouping enable/** With the track panels still selected use **Track grouping parameters...** to open the grouping parameters box. Here, for example, you can link volume (lead/follow) and/or pan (lead/follow).

An important feature in this menu is the ability to **Create new media/razor editing group for selected tracks** and to subsequently **Remove selected tracks from all track media/razor editing groups**. There are also options to **Automatically group all/selected tracks for media/razor editing**.

[Razor editing](#) and its many benefits are explained in detail in Chapter 7.

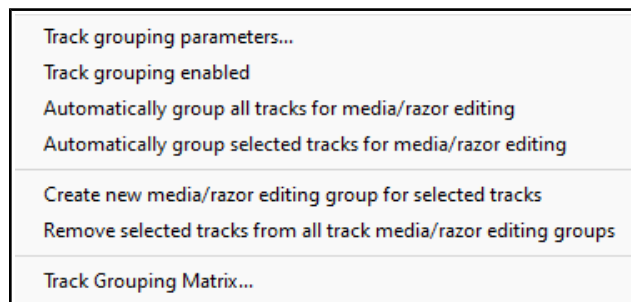

Project Arrangement Basics

5.18 The Main Toolbar

REAPER's default toolbar is located near the top left corner of the screen. The various tools and their functions are introduced throughout this guide as required: you might find the summary diagram below helpful. The icons might appear different if you are using a theme other than REAPER's default.

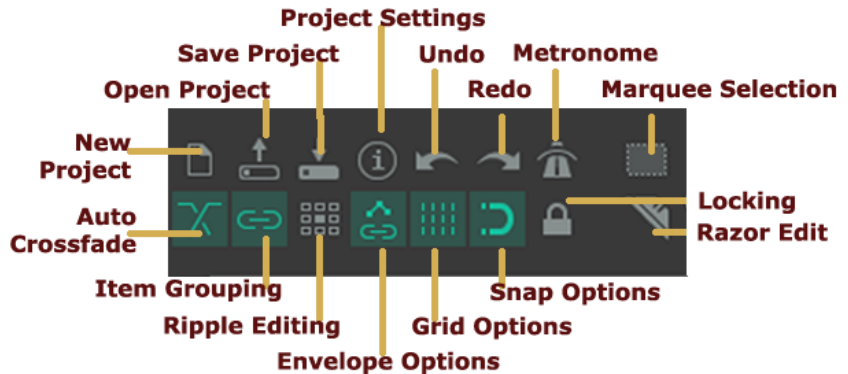

New Project: **Ctrl N**

Open Project: **Ctrl O**

Save Project: **Ctrl S**

Project Settings: **Alt Enter**

Undo: **Ctrl Z** to undo last action

Right click to view undo history

Redo: **Ctrl Shift Z** to redo last action

Right click to view undo history

Metronome: no default shortcut:

Left click to toggle on/off

Right click for settings

*Marquee Selection: On/Off

Auto Crossfade: **Alt X** to toggle on/off

Item Grouping: **Alt Shift G** to toggle on/off

Right click for menu

Ripple Editing: **Alt P** to cycle between disabled, per track and all tracks. Right click for menu. Options include *Ripple edit all affects tempo map* and *Ripple edit all affects envelopes on all tracks*.

Envelopes, move points with media items:

Left click to toggle on/off

Right click for menu of Envelope points, Automation items and Razor edits options.

Grid Lines Options: **Alt G** to toggle on/off

Right click for settings dialog

Snap: **Alt S** to toggle on/off

Right click for settings dialog

Locking: **L** to toggle on/off

Right click for settings dialog

*Razor Edit: On/Off

You can [edit this toolbar](#), for example adding more tools for other commands and actions. You can also create additional toolbars of your own. This topic is covered in Chapter 15.

Note 1: Right-clicking on some of these tools (e.g. Ripple Editing, Item Grouping, Snap Options) offer more functionality – such as a sub-menu, or a dialog box. These will each be explained as they are introduced.

Note 2: Some of these tools may appear on your screen to be animated. The section immediately following this one deals with this topic.

Note 3: The two icons flagged with an asterisk (*) - Marquee selection and Razor edit - are mutually exclusive. They determine how mouse modifiers will behave in each of these contexts.

5.19 Animated Toolbar Icons

Some icons on your toolbar are animated by default. Many icons, including toggle icons and those that you add yourself, can be animated. The main exceptions are tools that simply execute a command, such as New Project. The item grouping and move envelope points with media items tool are animated by default..

Toolbar animation is managed in the **Customize menus/toolbars** dialog (see [Customizing REAPER Toolbars](#)).

1. Right click over the toolbar background area and choose **Customize toolbar ...** from the menu. This will open the Customize menus/toolbars dialog with **Main toolbar** selected.
2. In the first column, right-click on the name of the tool that you wish to modify. From the context menu choose **Highlight with animation based on toggle state**.
3. A submenu of options will be displayed. (explained below. Make your choice(s) from this submenu.)
4. Click the **Apply** button. When you have finished making your changes click on OK.

Animation submenu options

Do not animate, Animate if toggle state enabled, Animate if toggle state disabled: these three options are self-explanatory and mutually exclusive. Select whichever you require.

Highlight animation or **Armed animation**: you can select either one of these visual effects, or one of the blink options. **Slow blink** or **Fast blink**: these cause the selected tool to blink, or flash, between two color states. In the default theme these are red and green.

Note: Toolbar animation can be disabled globally or for armed toolbar buttons by setting these options off on your **Options, Preferences, Appearance** page.

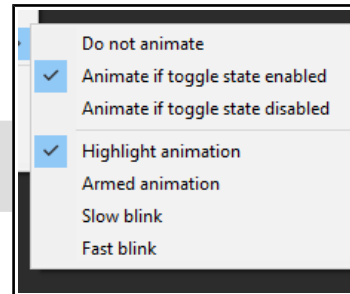

5.20 Track Layout Options

REAPER's default theme offers you a several out-of-the-box layouts from which you can choose. There are six areas of interest – the track panel, the master track panel, the mixer panel, the master mixer panel, the transport panel and the envelope panel. Some layouts are better suited to beginners than others, others will be preferred by experienced users. This section will introduce you to track layout options..

Later in this user guide you'll be introduced to the **Theme Adjuster** which you can use to create custom layouts to suit your particular preferences.

By default, REAPER selects **Layout A** for the track panel. Remember that this layout:

- ◆ Potentially shows all track controls when the mixer is closed (but see next point).
- ◆ Shows the **Record input** and **Input** controls only when the **Record** button is armed.
- ◆ Shows only a limited selection of track controls when the mixer is open – Record arm, Volume, Mute, Insert, Routing and FX.

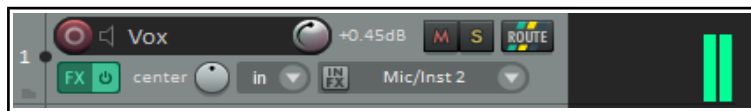

Layout B shows all track controls on all tracks if there is sufficient room.



Layout C shows the controls shown here, together with a horizontal VU meter.

To select a layout for all tracks first make sure no tracks are selected: to select a layout for particular tracks, first select the track(s) as required. Then, from the menu choose **Options, Layouts, Track Panel** then **A, B, or C**, or, to restore default layouts choose **Default layout**.

Note that for the **Master Track Panel** there is currently only one option available, the default.

Note: Several of the examples covered in this guide will feature track layouts that differ slightly from these three variants. In some cases, this is because the REAPER 6 theme is also available to you.

Managing Track and Item FX

6 Managing Track and Item FX

We have already covered the [basic techniques involved in using effects](#) on your REAPER tracks. We are now going to look at some of the options available to help manage and use your FX more effectively. We'll be looking in more detail at how you use some of the more important individual effects later (Chapter 16): in this section we're mainly concerned with the broader issues of managing and organising plug-ins.

6.1 Grouping FX in Folders

REAPER automatically groups your FX in various ways – by type (VSTi, VST, JS, etc.), by category (Analyzer, Dynamics, EQ, etc.) and by developers (e.g. Melda, Voxengo, Wave Arts). In addition, you can create your own group folders.

FX can be grouped as you wish. For example, you might wish to create a folder called Chorus/Delay/Reverb to display these plug-ins together. You can create as many folders as you wish, and the same plug-in can be placed in more than one folder.

The use of smart folders can make this job easier (by automatically adding plug-ins to your folders for you). You can also drag and drop selected FX into your folders. The table below summarizes how to work with folders.

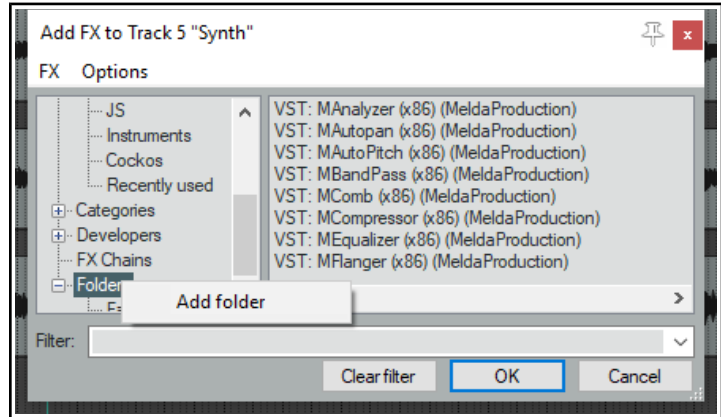

In order to do this ...	You need to do this ...
Expand/collapse folder contents list	Use the +/- button to the left of top level folder names.
Add a new folder	Right click over Folders (see above) and choose Add folder . Type a name in the Create New Folder text edit box and click OK.
Add a new smart folder	Right click over Folders (see above) and choose Add folder . Type a name in the Create New Folder text edit box. Type your filter in the Filter text edit box. OR and NOT can be used as keywords. An example is shown here. For more about filters, see Using Search Filters .
Add FX to a folder (including smart folders)	Drag and drop from FX list in right-hand pane. Ctrl click can be used to build a selection.
Display folder contents	Click on folder name in left hand pane.
Add FX to track or item	Double click on FX name in right-hand pane.
Change order in which folders are listed	Drag and drop folder name up or down, or select and use Ctrl Up and Ctrl Down .

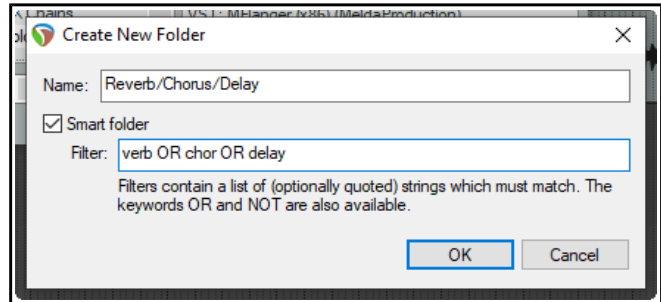

6.2 Using Boolean Search Filters

Search filters can be used to help find exactly what you are looking for. In this case, you can filter the FX list to show only those items which include a specified string, such as **verb** or **eq**. The techniques explained in this section can also be used elsewhere in REAPER where filtering is available – for example, the [media explorer](#), the [track manager](#), the [actions list](#), the [region/marker manager](#), the [project bay](#), [envelope color overrides](#) and the [theme development tweaker](#).

By entering a text string in the **Filter list** text box in the bottom left corner of the **Add FX** window (also known as the **FX browser**), you can display a list of those list items which match your criteria.

Before doing this, you can select either **All Plugins** from the list of plugin folders, or any particular folder if you wish to restrict your search to that folder. In the example shown above, we have applied the text string **chorus** as a filter, in order to see what chorus plug-ins we have available. The search string is not case sensitive.

You can search for more than one string within the same names. For example:

eq stereo will find all plugins with both *eq* and *stereo* anywhere in their name, regardless of the order in which they appear. **eq AND stereo** would produce exactly the same results.

Remember, you can rename individual plug-ins. This might make your searches more useful.

The filter also supports other Boolean search terms notably **OR** and **NOT**, and the use of parentheses, e.g.:

comp OR lim finds and lists all plugins with *comp* or *lim* in their name.

eq (cockos OR melda) finds all Cockos and Melda plug-ins with *eq* in their name. You must leave a space both before and after the parentheses.

cockos (eq OR comp) finds all Cockos plug-ins with *eq* or *comp* in their name.

blue cat NOT (flange OR phase) finds and lists all Blue Cat plug-ins except those with *flange* or *phase* in their name.

(chorus OR delay) NOT (DX: OR JS:) finds all effects with *chorus* or *delay* in their name except Direct X and JS ones.

There are some additional techniques that you can use to make your searches more finely tuned.

Enclosing a search string in quotes will find only those plug-ins where the text is matched exactly. For example:

"sony noise" would find Sony Noise Gate but not Sony Express FX Noise Gate. Likewise **"reaverb"** would find ReaVerb but not ReaVerbate.

Typing a space immediately after the opening quotes mark will limit the search to those items where the specified string is at the very beginning of a word. For example:

" volu" will find plug-ins which include the word *volume* but not *convolution*.

Similarly, typing a space at the end of the string will only find those items where one of the words in the FX name ends with that string.

Starting a search string with **^** will find only those items whose name begins with the specified string, and using a **\$** at the end of a string will find only those names that end with that string.

For example, when working in the [media explorer](#), using **^blues** as a filter would list only those items whose names begin with *blues*.

Similarly, in the [track manager](#), a filter such as **guitar\$** would display tracks with names such as *lead guitar* or *rhythm guitar* but not *guitar solo*.

The **Clear Filter** button can be used to remove the filter and restore all plug-ins to view.

You also have two options (on the **Options** menu – see below) which if enabled will ensure that your filters are automatically cleared for you. These are **Auto clear search field on folder change** and **Auto clear search field on close**. This latter option refers to closing the FX browser window, not closing REAPER.

REAPER will remember your previous filters. You can access it from the filter drop down list, by clicking on the down pointing arrow located on the edge right of the *Filter list* box.

In REAPER's [Plug-ins Preferences](#) (Chapter 22) there is an option to apply a global filter to all browser views.

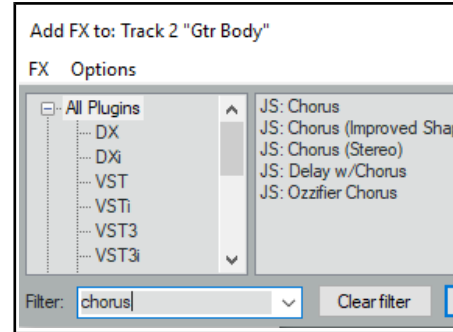

Managing Track and Item FX

6.3 FX Browser Options

The **Add FX** window Options menu is shown here. The commands are:

Auto-float new FX windows. If enabled, FX will be opened and displayed in their own separate window when they are added.

FX Plug-ins settings... Displays **Options, Preferences, Plug-ins** settings page (see Chapter 22).

Remove all empty folders. Removes all empty folders.

Show in left pane list. Displays a sub-menu to select plug-in categories to be displayed in the left pane of the FX browser window.

DX, DXi, VST, VSTi, VST3, VST3i, AU, AUi, JS, Rewire, Cockos Instruments all virtual instruments will be listed together as well as in their native folders (VSTi, DXi, etc) if these are also selected.

Recent causes all plug-ins recently used being displayed here, as well as in their native folders.

VST folders causes all folders with VST plug-ins to be listed in the left pane under **My folders**.

Categories causes plug-ins also to be displayed grouped by function (e.g. Delay, EQ, Reverb, etc.).

Developers enables plug-ins also to be grouped by developers. **FX Chains** will cause FX chains to be listed.

Show in FX list

In the displayed FX list you can show any **Default preset** (along with the FX name), **FX shortcuts**, descriptions, or file names, or both for **JS FX**, the **Video processor** (see Chapter 20), and/or plug-ins whose name begins with a **#**. Renaming a plug-in to begin with a **#** hides it in the FX browser's FX list.

Always search all FX when using search field. If enabled, all FX will be searched, even if one type or category has been selected in the left pane.

There are also two **Auto clear search field** (filter) options – when you change your selected folder, and/or when you close the FX browser. Enabling the option **Auto-clear folder view on close** ensures that the next time the Add FX browser is opened All Plugins will be selected in the left panel.

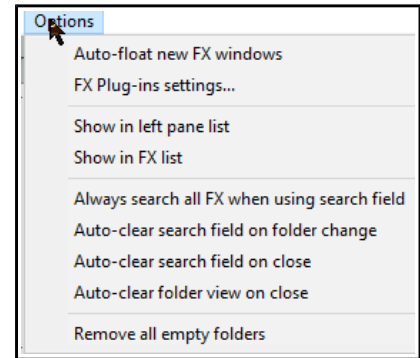

6.4 Item Take FX

REAPER allows you to apply FX directly to media item takes within a track. For example, you might wish to add reverb or delay to just part of a track. You can split the track media into several items and apply the effect only to those items where it is wanted. If you have selected the option to display the **Per take FX** and **No FX** item icons (**Options, Preferences, Appearance, Media**) you can click on any item take's **FX** button to open its FX window. Otherwise you can select a media item and use the default keyboard shortcut **Shift E**.

In order to do this ...	You need to do this ...
Add plug-in to an item's FX chain	Press Shift E to open the item's FX window, or drag and drop FX from the FX browser on to the item take.
Delete an item's FX chain altogether	Select the first item in the chain then hold Shift while selecting the last item. Then press Delete .
Copy an FX or entire FX chain to another item	Ctrl drag FX from an item's FX chain to the other item. Ctrl drag from the FX button to the other item to copy the entire FX chain. Ctrl Shift to include envelopes.
Move FX from one item to another	Hold Alt while dragging and dropping the FX.
Manage item take FX	Take FX windows include the same commands (toggle bypass, toggle offline, etc.) as track FX windows. Actions are also available.

Your **Appearance, Media** preferences settings determine if and how the various buttons are displayed for individual media items. These are covered in detail in [Chapter 22](#), but for now just notice that available item icons (buttons) include its lock and mute status, its FX chain, its notes and properties.

If you enable the option **Draw labels above the item rather than within the item** then the buttons will be displayed (with the item name) above the item. You can, however, also specify as an exception that **When media item height is less than label height** the label should be moved to inside the media item. If you disable these options, the labels (if displayed) will always be superimposed on the media item itself.

For a bound hard copy of the latest version of this User Guide (printed in B&W) go to LULU.com

Up and Running: A REAPER User Guide v 7.31

6.5 Managing FX: Tips and Tricks

These techniques are available when working with track and item FX, unless the track or item is locked.

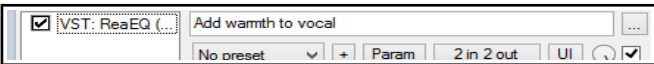
In order to do this ...	You need to do this ...
Customize FX chain window appearance	Options, Preferences, Plug-ins has options to Show FX list on right side of window and/or Show FX chain buttons above FX list .
Toggle Add FX vertical/horizontal display	Use the Options, Vertical pane configuration toggle command.
See track/item FX chain overview	Hover mouse over track or mouse FX button, without clicking. A tooltip will appear listing contents of the track/item FX chain.
Open FX from track/item FX chain	Right-click on track FX button (arrange or mixer view) to display list of FX on track/item FX chain. Left-click on required FX.
Rename an FX	Right click on FX in the Add FX window, choose Rename FX ... from the menu.
Replace an FX with another	Right-click over the FX in the track or item FX chain. From the context menu choose Replace FX ... Select required FX from the list displayed and click OK .
Copy an FX from one track/ item to another	Drag and drop the FX from the track or item FX chain to the track control panel of the destination track, or to the destination item.
Move FX	Hold Alt while dragging and dropping from source to destination track or item.
Move/Copy FX including automation	Right click on FX name in browser left panel choose Copy or Cut selected FX (including automation) . Paste into destination track/item FX chain.
Insert multiple FX to a track at once.	Use Ctrl click to build selection, then click OK. If you need to set (or unset) HiDPI compatibility mode, before clicking OK, right click over any item in the selection and choose HiDPI compatibility mode when floating windows .
Copy multiple FX to another track/item	Use Ctrl click to make selection from the source FX chain, then drag and drop to the destination track or item.
Add FX to track directly from track panel.	Right-click over FX button, select FX from menu, or from one of the submenus (e.g. Recently used, Categories).
Add FX directly from FX browser window.	Drag and drop from the Add FX browser window directly to track panel or to item take.
Adjust FX parameter controls (faders, knobs)	For Cockos and JS plugins, these work in the same way as do track controls: Drag for normal adjustment. Ctrl drag to adjust in smaller increments. Alt drag to snap back to previous setting when mouse is released.
Create FX shortcut keys	Right-click on FX name in FX browser. Choose Create shortcut from menu. To open the Keyboard/MIDI/OSC Input . Press the required key combination on keyboard (e.g. Ctrl Alt A) and click on OK .
Add notes to an FX instance	Click in text edit box above presets list.  Type your notes/comments. For longer entries, click on the ... (top right) to open a text box.
Rename FX track/item instances	Right-click over the FX instance in track/item FX chain. Choose Rename FX instance from menu. Type new name, press Enter .
Change default FX name	Right-click over FX name in FX browser window. Choose Rename from menu. Type new name then press Enter . Cannot be used with JS effects.
Change FX default parameter settings	Set FX parameter values as required. Click on + button just above the FX gui. Choose Save preset as default , type a name then press Enter .

For a bound hard copy of the latest version of this User Guide (printed in B&W) go to LULU.com

Managing Track and Item FX

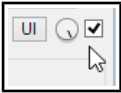
In order to do this ...	You need to do this ...
Restore original FX default settings	Click on down arrow (next to + button) to display preset list. Choose Reset to factory default . Click on +, choose Save preset as default .
FX Wet/Dry mix and FX bypass	The rotary Wet/Dry mix button (to the right of the UI button) controls how much of the wet signal (i.e. with FX) is mixed in with the dry (i.e. pre FX) signal. The default is 100% wet. The checkbox to its immediate right can be used to bypass the FX altogether. 
Force auto-bypass on silence	Right click on plug-in name (left column) and select this option from menu. This, for example, can be used to prevent a reverb tail during a silent passage. The silence threshold is defined in advanced project settings .
Back up FX chains and presets	These can be backed up and restored using the export/import configuration buttons in REAPER's Preferences (General settings) . See Chapter 22 for more information about importing and exporting configuration setting
Other FX Options	The FX window menu includes several advanced options dealing with PDC mode, oversampling, and more. These are discussed at the end of the REAPER Plug-ins in Action chapter .

6.6 Controlling FX from the TCP

Rea plugins with their controls can be displayed in the TCP. Right-click over the FX name in the FX chain panel and choose **Show embedded UI in TCP**. The FX will be displayed as shown here, with a number of slots to its left.

Right click over any slot, select the FX from the menu, then the control to be displayed. This is illustrated on the right.

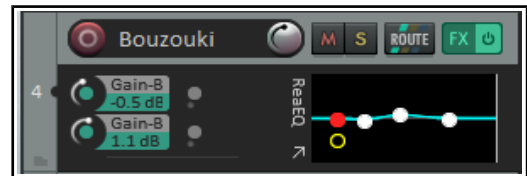

6.7 Managing FX Parameters

Click on the **Param** button then **FX parameter list** in any FX window for a range of FX parameter management option, or click on any parameter control in the FX window then on the **Param** button to open a menu (right).

Show in track controls. This adds a control knob for any parameter to both the Track Control Panel (TCP) and the Mixer Control Panel (MCP).

Alternately, choose this command without first touching any control to display a list of parameters for this particular FX. An example (using two parameters from JS Chorus) is shown here (below right). To remove any of these controls, right-click over the control and choose **Remove from list** from the menu.

Show track envelope. Automation envelopes can be added for any FX parameters. These can be displayed in their own lanes. See [Chapter 18](#).

Parameter Modulation. This is an advanced topic. Parameter modulation allows you to define a relationship between two parameters so that one is controlled by the other. For example, you might want a threshold's ratio to automatically increase as the threshold is lowered. This topic is explained in [Chapter 19](#).

MIDI link. This lets you map track MIDI (not control MIDI) to the parameter. Thus, for example, you could use recorded MIDI CC as automation. This is explained in the chapter dealing with [Parameter Modulation](#).

Learn. If using an external MIDI control device you can assign FX parameters to controls (such as knobs or faders) on that external device. This topic is covered in detail in Chapters [12](#) and [19](#).

Alias parameter. This allows you to change for the single instance the name of a parameter.

FX parameter list. This can be used to assign track controls, a track envelope, parameter modulation, MIDI link, Learn or an Alias name directly from the menu to any of the FX's parameters.

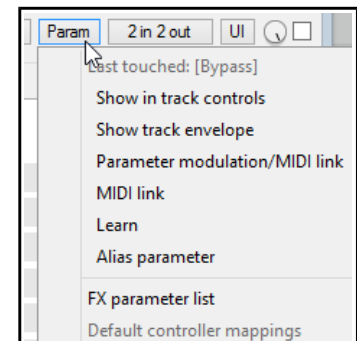

6.8 Serial vs Parallel FX Chains

By default, the plugins in a track or item FX chain are processed in serial – that is, one after each other. For example, if you insert both ReaEq and then ReaComp into an FX chain, the audio is passed first through the EQ. With EQ added, it is then passed through the compressor. This concept is illustrated on the right. This is how most often you are likely to want to have your FX processed.

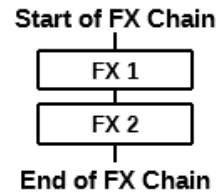

However, there may be instances when rather than processing effects in serial you wish to process them in parallel. That is, you wish to process two or more effects (in this example, EQ and compression) each independently of the other, with the separately EQ'd and compressed audio then mixed back together. Using this method, you can avoid applying the compressor to the EQ'd signal.

This concept is illustrated in the second diagram on the right.

The steps required to run two effects in parallel are simple:

- ◆ Insert both of the FX into the track or item's FX chain.
- ◆ Right click over the second of these FX and from the context menu choose **Run selected FX in parallel with previous FX**.

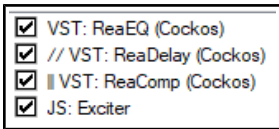
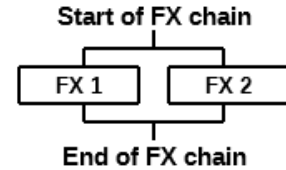

This is illustrated in the chain shown on the left. The two sets of lines indicate that after passing through ReaEQ the audio stream will be processed by ReaComp in parallel with ReaDelay before being passed on through the JS Exciter.

This technique can be used in any number of cases to explore creative effects. For example, you could use it to apply reverb and compression independently of each other to an instrument, or two separate instances of compression to a vocal.

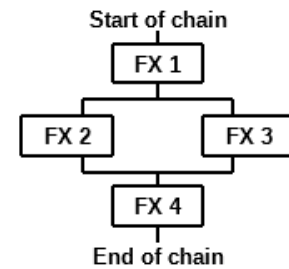

Parallel FX processing can also occur within more complex models. Consider the third illustration shown on the right.

Here we have four FX in a chain: the audio is first processed through FX1, then FX 2 and FX 3 (and only FX 2 and FX 3) are processed in parallel. To achieve this, FX 3 (and only FX 3) needs to be set to run in parallel to its immediately previous FX. Finally, the signals for FX2 and FX3 are merged and passed through FX 4.

More complex models are available: more examples, including FX containers, are considered in [Chapter 17](#).

Note: If MIDI items are being processed through midi FX in parallel which filter their own events you should instead use the command option **Run selected FX in parallel with previous FX (merge MIDI)**. This should prevent MIDI data from being excluded.

6.9 Duplicate Plug-in Priorities

REAPER supports plug-ins of different types – on the PC, for example, VST2, VST3, CLAP and LV2 are supported.

In the FX browser window, you can specify your order of priorities for identical plug-ins of different types.

From the **FX Browser** window, choose **Options, Duplicate plug-ins of different types**, then whether or not to **Show all duplicates**

and then specify when such duplicates of different types are found which is to be first, second, third and fourth priorities.

This can be especially useful, for example, if you regularly use both VST2 and VST3 plug-ins.

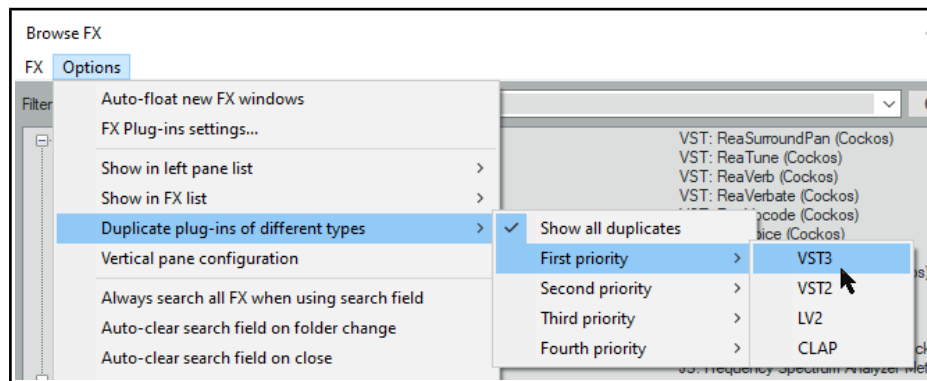

Managing Track and Item FX

6.10 Advanced Plug-in Defaults

There are a number of options available in the Add FX browser which you can use to define default settings for individual plug-ins. These will automatically be applied to that plug-in instance whenever it is added to a track or media item.

Most of these deal with advanced technical matters: if you a relative newcomer to digital audio, you might wish to skip over this section.

You can access these by right-clicking over any plug-in name in the FX browser list.

Right-click on any FX in the FX browser for a menu of options. Most of these are explained in the section [Track FX Basics](#). In addition, the following options allow you to set individual plug-in defaults.

Menu Item	Submenu options
Run as	The default setting is Automatic , but you can change this to any of Separate process , Dedicated process , Native only (prevent bridging). There is also an option to Embed the bridged UI . For more information, see Bridging and VST Plug-in Run Mode .
Compatibility settings	This is especially useful for plug-ins that might have known or suspected compatibility issues. You can enable or Options available are Save minimal undo state , Avoid loading undo states where possible , Inform plug-in when track channel count changes , Hard reset on playback start , Hard reset on playback start , Save state as VST bank , Buggy plug-in compatibility mode , HiDPI compatibility mode when floating windows . There is also a further sub-menu to manage Automation notifications . Options are Defaults (set in preferences), Ignore when plug-in window not open , Ignore when not from UI thread , Ignore all notifications , Process all notifications . For more information about some of these options, see the section VST and VST3 FX Compatibility Settings .
Default settings for new instances	Any of these options can be enabled if you wish them to be automatically applied whenever the particular FX is added to a track or item: Send all keyboard input to plug-in , Show embedded UI in TCP or MCP (if supported), as well as a sub-menu of options for FX instance oversampling . Options are Up to 88.2k/96k , Up to 176.4k/192k , 352.8k/384k , or Up to 705.6k/768k . The section FX Chain and FX Chain Options explains oversampling.

6.11 Advanced Floated FX Window Options

The essentials of floating individual FX windows have been covered in Chapter 2: see [Controlling Track FX](#). In addition, a number of more advanced options are available from a context menu (right-click on the title bar).

Menu Item	Submenu options
Embed UI in TCP or MCP	Where appropriate, these options will be enabled. See the section Embedding FX GUI in TCP or MCP .
Send all keyboard input to plug-in	Enabling this will ensure that keystrokes such as up and down arrows will be applied within the FX window rather than arrange view.
Chain/FX instance oversampling	This allows oversampling to be applied just to the individual FX instance, or to the track or item FX chain. Options are the same as in the table immediately above this one.

6.12 Embedding FX GUI in TCP or MCP

You can embed the GUI of some FX (e.g. ReaEQ, ReaComp, ReaXComp, ReaSurround and ReaFir, and some JS plugins) in the TCP/MCP, including graphical waveshapers, the spectrograph and the goniometer.

Right-click on the FX in the track's FX chain and choose **Show embedded UI in TCP** or **MCP**. For example, you could adjust visible ReaEQ parameters within the TCP.

Tip: After embedding an FX (such as ReaEQ shown here) in a track's UI you can save it as a FX chain (from the FX window menu). Inserting that chain into the FX chain of any other track will then also cause the FX to be automatically embedded in that track's UI.



6.13 Hardware Output FX Monitoring

To open the **FX: Monitoring** window use the **View, Monitoring FX** command from the main menu, or hold **Shift** while clicking the FX button of the Master track. You can specify any FX that you want to put on your hardware outputs. These do not show up in renders, do not affect the metronome and are not stored in the project file. You might use this feature, for example, to run analysis FX, or to compensate for the acoustic characteristics of a particular room. Within the **FX:Monitoring** window, click on the **Param** button then **Learn** to assign control of any selected FX parameter to an external control device.

6.14 Optimizing FX Performance

Some plug-ins can be quite greedy in their use of CPU, especially delay based FX, such as delay, chorus, and especially reverb. REAPER provides a number of options which you can use to minimize the drain placed on your computer resources by your plug-ins. These options can be found in the **REAPER Preferences** window (**Ctrl P**) under the heading **Audio, Buffering**. This window is shown and discussed further in [Chapter 22](#).

There is no "one size fits all" optimal group of settings. What is best for you depends on various factors, including which processor(s) you are using and which plug-ins. Note in particular the following:

- You can try using the default settings for **Media Buffering** at first. You can adjust them later if needs be.
- **Allow live FX multiprocessing**. Try turning this on if your PC has multiprocessors.
- **Anticipative FX processing**. This can reduce CPU usage, but too aggressive a setting can cause pops and crackles on playback. If working with UAD-1, for best results, both Synchronous FX and UAD-1 Synchronous modes should be enabled. Anticipative FX should be disabled. UAD-2, however, is compatible with Anticipative FX mode and this is recommended for best low latency performance..

Optimize buffering for low latency hardware.

If a plug-in has problems with media buffering or anticipative FX processing, you can disable either or both for individual tracks using the **Track Performance Options** on the TCP right-click menu. Options include enable/disable media buffering, anticipative FX, track metering, and/or display of spectral peaks.

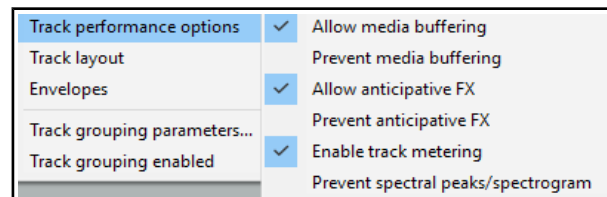

6.15 Plug-in Delay Compensation

By default, REAPER uses plug-in delay compensation (PDC) to ensure that the audio from your tracks remains time aligned. This, for example, is likely to be needed when one or more FX chains includes a plug-in such as reverb. *In most circumstances it would be unwise to alter REAPER's default PDC settings.*

Nevertheless the FX chain FX menu allows you to manage **Chain PDC mode** for an item or track by setting it to **Per chain compensation**, **Per FX compensation** or to **Ignore plug-in delay**.

For the master track, there is also an option to select **Hardware output compensation**.

An option is also available from the **x in/ x out** button context menu of individual plug-ins.

Adjustments can be made to compensate for any latency caused by a plug-in. The latency

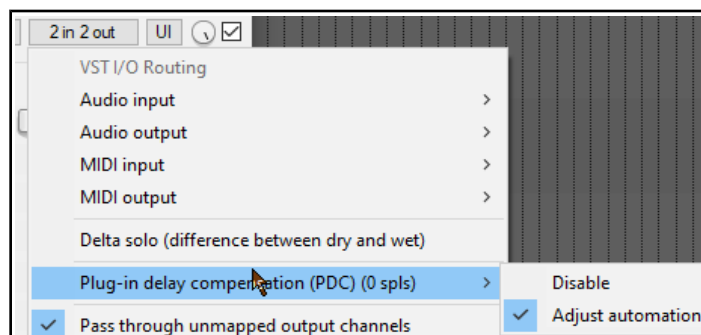

Managing Track and Item FX

for any track is displayed in the bottom left corner of its FX chain window. The track media is read in advance, allowing it to be heard at the correct time, but input monitoring is delayed.

If you find that PDC is creating problems (for examples, dropouts or excessive latency) then it can be disabled for any plug-in from the pin connector button (shown above labelled "2 in 2 out") context menu. Note too that PDC is disabled when feedback routing is employed.

6.16 Opening a File in Recovery Mode

Any computer program will crash given the right (or wrong?) circumstances. This can be because of a problem with some third party plug-in. If this happens, you should enable the option to **Open with FX offline (recovery mode)** when re-opening the file from the **File, Open project** dialog box (see right).

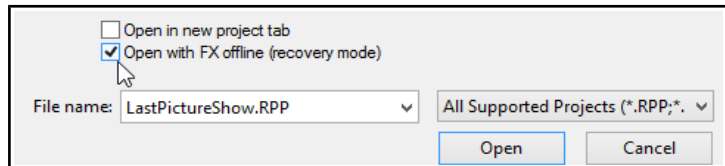

This will open the file with all FX set offline.

By reintroducing them online one at a time, you should be able to identify which one is causing the problem. To then fix the problem you should remove this plug-in and replace it with another of equivalent functionality.

Another method is to hold down **Alt** while you open a file from the **File, Recent projects** menu.

6.17 Freezing and Unfreezing Tracks

The **Freeze tracks** actions (from the track panel right click menu **Render/freeze tracks** command) freeze any track in place, replacing its contents with a single rendered audio item. The first of these actions shown (right) will produce a **mono** audio item for each track frozen, the second **stereo** and the third **multichannel** (according to the number of track channels). If multiple tracks are selected, each will be rendered separately.

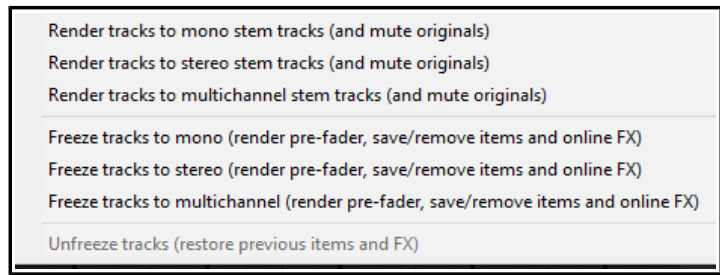

On line FX are applied to the rendered item, as is the content of any signals sent to the rendered channels from other tracks. Where these include MIDI data or items, they will be rendered as audio. Both on line FX and receives are then removed from the track. Note that a MIDI item with no synth attached to it will be rendered as silence. Where a synth is present, it is the output of the synth that will be rendered.

When a track has already been frozen, **Unfreeze tracks** will appear on the above menu as an action that can be used to restore the track to its state at the point in time that it was frozen. Both the FX chain and any receives will be restored. Other points to note are:

- A track can have further FX and receives added to it after it has been frozen. In this case, if you then freeze the track again, these FX (along with audio and or MIDI material from the new receives) will be rendered together with the existing frozen material to another new audio item.
- Each unfreeze action will remove the previous freeze on that track and restore it to its state at the time of that freeze action. Thus, if a track has been frozen, had more effects added and been frozen again, then you will need to unfreeze it twice if you wish to restore it its state immediately before first being frozen.

Using the Track Manager

Freezing can also be handled using the **Track Manager** (from the **View** menu). You can drag and drop headers to change the column order. You can select any track(s) from the list then click on the **Freeze** button to select an option (mono, stereo or multichannel). The number of times any track has been frozen will be shown in the Freeze column.

An **Unfreeze** command will be available on the Freeze menu when that menu is displayed with a frozen track selected. This will include an option to display the freeze details for that track.

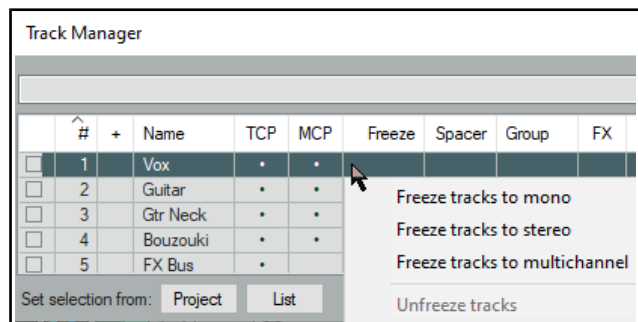

Selected FX Freeze

Other FX chain right click menu options are to freeze a track up to its last on-line or selected FX, as you wish - see right. In this case, only the first three FX have been selected. The action **Freeze track to stereo, up to last selected FX** will cause these three FX to be frozen on to the track. These FX will be removed from the track's FX chain. The other effects will not be rendered to the new audio item. If this track is later unfrozen, the removed FX will be restored.

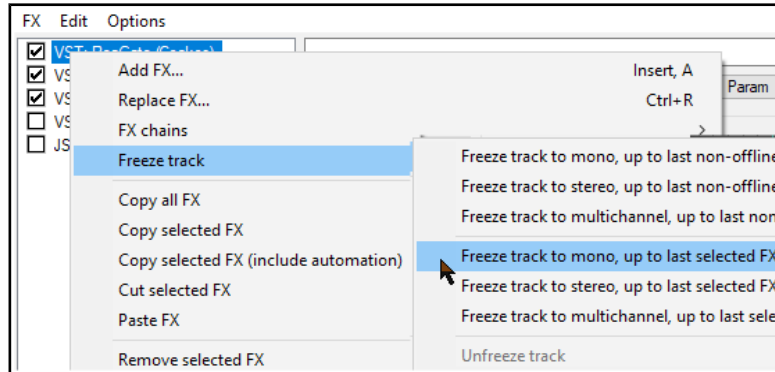

One useful action (accessible from REAPER's Action List window) is **View: Show track freeze details**. This can be used to display freeze history and details for any frozen track. Chapter 15 explains in detail more about actions and about how you can [assign them to toolbars](#) or to [your own shortcut keys](#).

6.18 The JS Analysis Loudness Meter

[Elsewhere in this guide](#) you will be introduced to various JS plug-ins. One worth looking at now is the **Loudness Meter**. This can display visual feedback about LUFS (loudness unit full scale), RMS (root mean squared) and True Peak loudness. Insert it into any track or master just as you would any other plug in.

Peak: Highest actual level of the audio signal..

True peak: Highest level of the oversampled signal. Intended to estimate the highest level the signal could reach after resampling to any sample rate.

LUFS: The loudness of the digital signal, after applying filters intended to adjust for how humans perceive different frequencies.

LUFS-M: Momentary loudness measured over a 400ms window.

LUFS-S: Short-term loudness measured over a 3 second window.

LUFS-I: Integrated loudness of the entire audio signal, beginning to end.

LRA: Loudness range, the dynamic range of the entire audio signal, measured as the statistical difference between the lowest and highest LUFS-S measurements.

Click on the settings (question mark) symbol (bottom right) to toggle display of options/controls, including what data to display and y-axis scaling and text size. See also [Chapter 11](#). The various parameters can also be automated (see [Chapter 18](#)). There is also an option for output loudness values as automation to be inverted.

The small orange symbol above the ? can be used to toggle between stereo (default) and mono analysis.

If you're unsure as to what to display, leave the settings at their defaults.

The [Actions List](#) (see Chapter 15) includes several actions to calculate and display the loudness of the master mix, selected tracks, and/or selected items, according to various criteria. Use the search filter **calculate**.

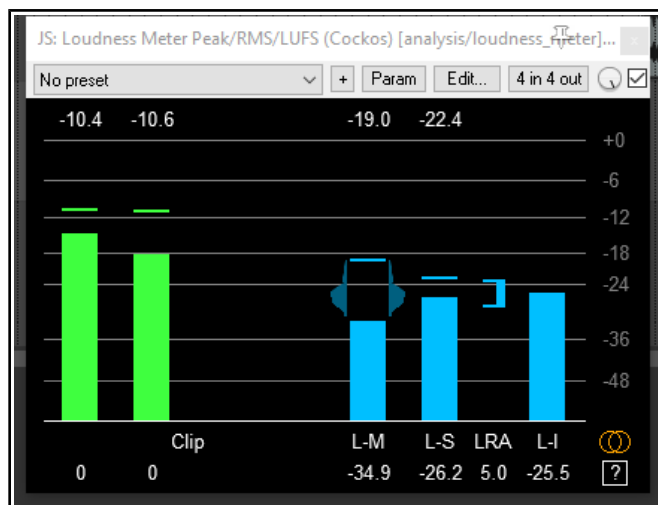

6.19 VST and VST3 FX Compatibility Settings

Various compatibility settings are available for VST FX plug-ins. These are available by clicking on the + button in the plug-in's window (immediately left of the **Param**) button and choosing **Compatibility settings** at the foot of the menu that is displayed.

For example, you can **Save minimal undo states** if you wish, and/or **Avoid loading undo states where possible**. Other options include **Inform plug-in when track channel count changes**, **Hard reset on playback**, **Save state as VST bank** and **Buggy plug-in compatibility mode**.

Managing Track and Item FX

The **Automation notification** options let you over ride various VST preferences settings for specific plug-ins. For VST3 plug-ins, if using sidechaining you may need to **Request VST3 bus channel count** to inform the plugin how to interpret the channels REAPER is sending This is because REAPER does not have dedicated sidechain buses. This command is available on the plug-in's right-click **In/Out** menu, next to the **Param** button.

6.20 Missing Items

If since saving a project file you have deleted from your hard drive, or moved, any VST or other FX used in that project, then when you next open that project REAPER will give you a message about missing items. You can still load the project file, the FX will still be listed in the track FX chain but it will not be available. You can remove the FX from the chain and replace it with another, or reinstall the missing FX on your computer and then insert it.

6.21 Installing Extra JS Plug-ins

More free JS plug-ins are available at stash.reaper.fm/tag/JS-Effects. To install any of these:

1. Download the effect. If the JS effect file has a .txt extension, edit the file name to remove this.
2. Copy the effect to your REAPER Application Data Effects folder. To find this choose the command **Options, Show REAPER resource path ...** You can place it in a sub-folder within the Effects folder.
3. Close and restart REAPER.

Some JS FX come with other files (such as data files or image files). As a rule, data files are placed in a sub-folder in the Application Data Data folder, and other files are placed relative to the JS FX file. In most cases where this is necessary, the JS effect developer will supply specific instructions with the effect.

6.22 ReaEffects User Guide Supplement

You will find many examples in this User Guide of the use of various COCKOS effects, especially in Chapter 16. In addition, a free PDF ReaEffects Summary guide can be downloaded from this case sensitive URL:

<https://dlz.reaper.fm/userguide/REAPEREffectsGuide2021.pdf>

6.23 Audio Signal Flow Chart: Master Track

The two diagrams that follow (in this section and the next) illustrate how audio signals flow thru REAPER's tracks to the master and to your output devices. Some of the items shown in these charts (e.g. Item/Take settings) have not yet been discussed in this User Guide. They will be covered throughout Chapter 7. This first diagram illustrates specifically the audio flow for the Master Track.

REAPER Audio Playback Signal Flow - Master Track

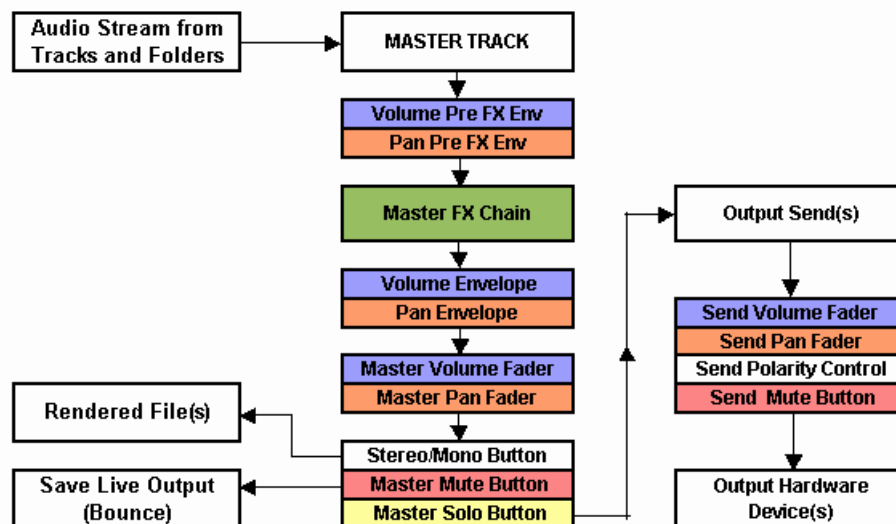

6.24 Audio Signal Flow Chart: Tracks and Folders

This diagram illustrates specifically the audio flow for tracks and folders.

REAPER Audio Playback Signal Flow - Top Level Track or Child Track

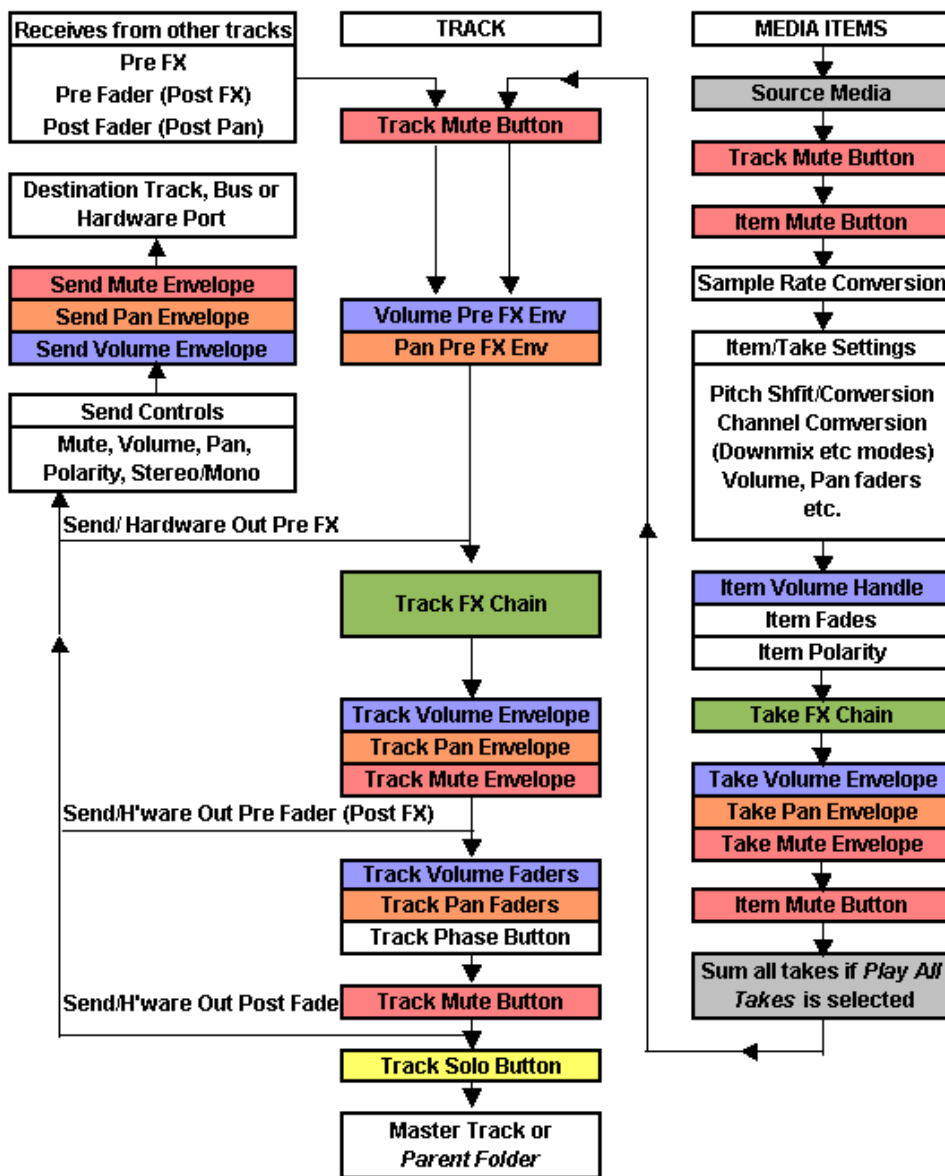

Notes:

1. The Trim Volume envelope (not shown) comes after the Track Volume envelope and before the Send/Hardware Out Pre Fader (Post FX).
2. The track mute button is shown more than once (near the beginning and near the end of the chain). This is because it does not only mute at the beginning (so that for example, all media items are effectively muted), it also mutes at the end (so that, for example, a synth in the track FX chain that is fed MIDI data via a receive from another track is also muted).
3. If track mute and track solo buttons are both enabled, then solo overrides the mute.
4. If the Master is soloed, direct outputs to hardware from tracks/folders will not be processed.

Managing and Editing Media Items

7 Managing and Editing Media Items

7.1 Using an External Editor

REAPER's native media item editing features are likely to be more than capable of meeting your needs. However, if you prefer to use a different application for editing you can specify up to two external programs (such as Adobe Audition, Audacity, Wavosaur or Sound Forge) for this purpose. To do this:

1. Choose the **Options, Preferences** command, then from the left column **External Editors**.
2. Click on the **Add** button.
3. Use the **Browse** buttons (see right) to identify and select your preferred editor(s).
4. Click on **OK**, then **OK** to close the 4window.

Notice that you can specify different editors for different file types, e.g. WAV, or MP3.

To use your external wave editor:

There are two main ways you can access your preferred external editing program from within REAPER:

- Select the media item and press **Ctrl Alt E**.
- Right click over the media item. From the menu, choose either **Open Items in editor** then, from the sub-menu, select either the option to open the item itself or to open a copy of the item.

Unlike versions of REAPER earlier than 4.0, by default double-clicking on an audio media item will no longer open it with your primary editor. This behavior can be changed thru the **Preferences, Editing Behavior, Mouse Modifiers** page if you wish. Select the context **Media item, double-click** and change the behavior as you wish. This topic is covered in [Chapter 15](#). If the external editor works destructively on your files then the safer option is to open a copy. This copy will then be inserted into your track when you save it, close the editor and return to REAPER. But first, take a look at some of REAPER's item editing capabilities ...

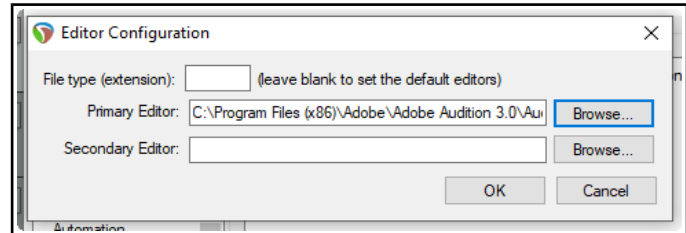

7.2 Editing Media Items in REAPER

This topic is a big one! REAPER features a comprehensive range of editing techniques for use with your media items and more. These techniques include (but are not limited to):

- Basic editing of media items.
- Time selection and item editing.
- Razor selection and razor editing.
- Spectral editing (covered at the end of this chapter).

Before exploring these, there are some basic concepts which you will need to understand about how REAPER' behaves when editing items: we can then go on to learn the different editing techniques. For example:

- All editing in REAPER is non-destructive. Edits made to items are unique to the in project item and do not in any way modify the source file. You can experiment knowing that your original recorded files are safe.
- Item editing in REAPER basically consists of selecting an item, or a portion of an item (range), then doing something to it – such as splitting it, deleting it, copying it or moving it.
- REAPER offers you two basic ways of editing media items – Simple editing, using shortcut key combinations only, and smart editing, using your mouse in conjunction with various modifier keys (Alt/Opt, Ctrl/Command, etc). Some functions are common to both methods, but, as a general rule, smart editing offers more sophisticated options than does simple editing. This chapter will explore and explain both methods.
- Razor editing offers a greater range of options and flexibility than do the other methods.
- Sometimes a number of steps might be required to achieve an editing task. If so, you can [assign a single keyboard shortcut to the entire sequence](#). Just how to do this is covered in Chapter 15.
- To a large extent, you can customize REAPER's editing behavior thru the [editing settings](#) and mouse modifiers within your Options, Preferences window. We'll get to this later in this section.

Remember that when editing you have available both the **Edit, Undo** command and the [Undo History window](#) (covered in Chapter 2). This Undo History window can be used to restore a project file to any earlier state.

Important note: automation envelopes: Automation envelopes are covered in detail in [Chapter 18](#). For now note that the option **Move envelope points with media items** (toggled on/off by clicking on the toolbar envelope tool) will determine whether envelopes and their points are moved/copied with their media items.

Up and Running: A REAPER User Guide v 7.31

7.2.1 Basic Editing: Media Items

Some, but not all, of REAPER's basic item editing tasks use familiar standard Windows procedures. These are mainly suited to simple tasks, such as moving or splitting media items, or joining items together. Shown below is a summary table. Remember, for Mac OS2 users, equivalent booster keys are **Cmd** for **Ctrl** and **Opt** for **Alt**.

To do this ...	You need to do this ...
Select media items	To select a single item, Left click . To add more items to the selection, Ctrl left click . To select a range of adjacent items, Left click on first item in range, Shift left click on last.
Split item(s) at edit cursor position	To split all items, make sure no item is selected, press S . To split one selected item or a selection of items, press S . Item FX will be applied to both items unless Media Preferences option Duplicate take FX when splitting items is disabled.
Split item (s) at prior zero crossing	Select item(s) at the approximate point in time that you want to split. Press Alt Z .
To join split items together (heal)	Select items. Choose Heal splits in items from the context menu.
To join selection of items (glue)	Choose Glue from the context menu (renders to new file).
To move item(s) with contents	Select item(s). Use Num Pad 4 (left), 6 (right), 2 (down), 8 (up).
To slide contents within item	Select item(s). Use Num Pad 1 (left), 3 (right).
To move item but not contents	Select item(s). Use Num Pad 7 (left), 0 (right).
To delete selected item(s)	Press Delete or chose Remove items from context menu
To cut/paste selected item(s)	Press Ctrl X . Re-position edit cursor, press Ctrl V .
To copy/paste selected item(s)	Press Ctrl C . Re-position edit cursor, press Ctrl V .
To cut that part of selected item(s) defined by time selection	Press Ctrl Shift X or choose Cut selected area of items from context menu. Re-position edit cursor, press Ctrl V .
To copy that part of selected item(s) defined by time selection	Press Ctrl Shift C or choose Copy selected area of items from context menu. Re-position edit cursor, press Ctrl V .

Vertically stacking overlapping items

You might wish to crossfade overlapping media items. This can be done manually, or automatically, by enabling the Auto Crossfade tool on the toolbar. Crossfade behavior can also be managed using the [Crossfade Editor](#) which will be examined later in this chapter. You can **Offset overlapping items vertically** (**Options** menu).

7.2.2 REAPER's Smart Editing

REAPER's smart editing lets you do some more complex editing tasks quickly and easily. In this section, we will look at smart editing techniques for moving, copying and deleting media items, selections of media items and parts of media items. To use them, make sure that the option **Loop Points Linked to Time Selection** is **disabled**. The tables below describe default behaviors: MacOS users should use **Opt** for **Alt** and **Cmd** for **Ctrl**.

Smart Editing with Media Item Selections

To do this with an item or selection of items ...	You need to do this ...
Select a single item	Click on the item.
Select several items or part of several items	Make any time selection. Right drag to marquee items, or Ctrl click for non-adjacent items.
Delete selected item or items	Select item(s), press Delete .
Delete part of selected item or items	Select item, make time selection. Press Ctrl Del .
Move item/items, ignore any time selection	Select items and drag.
Move item/items, ignore snap and time selection	Select items and Shift drag.

For a bound hard copy of the latest version of this User Guide (printed in B&W) go to LULU.com

Managing and Editing Media Items

To do this with an item or selection of items ...	You need to do this ...
Copy selected portion of item or items	Click on one item within time section and Ctrl drag. Shift Ctrl drag to ignore snap.
Copy entire item or selected items (ignore time selection)	Click on one item outside time section and Ctrl drag. Shift Ctrl drag to ignore snap.
Move item contents (within item)	Alt drag.
Adjust item pitch fine	Shift Alt drag up or down.
Render item to new file	Ctrl Alt drag.
Copy item, pooling MIDI source data	Shift Ctrl Alt drag.

To include an entire item in a marquee selection you need only to touch it with your mouse. In the example shown here, both media items would be included in the selection.

Tip: If you accidentally move an item, to return it to its original position choose **Item processing** then **Move item to source preferred position** from its right-click menu.

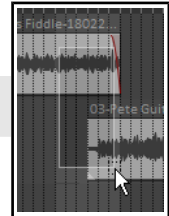

7.2.3 Smart Editing with Razor Edits

Razor selection and razor editing take smart editing further: they allow you, for example, to make selections of areas that can span multiple tracks/items, including non contiguous selections and even spaces. Your selections can include entire items, portions of items, automation envelopes, automation items, spaces before, after or between items and any combination of these – all without moving the edit or play cursor. For more about razor editing with envelopes and automation items see [Chapter 18](#). Meanwhile, note that unless you want envelopes automatically always included and moved/copied/stretched/deleted with your razor edit media selections, you should disable (on the envelope tool on the default toolbar) the option **Razor edits in media item lane affect all track envelopes**.

To do this with a razor selection ...	You need to do this ...
Create razor edit area from any selection of media items	SeleCreatect media items. Right-click on timeline, choose Enclose media items in razor edit from the menu.
Create razor edit area from a track selection	Use track panel context track grouping menu . See Chapter 5.
Remove track(s) from an existing razor edit area.	Use track panel context track grouping menu . See Chapter 5.
Create razor selection area by marquee	In arrange view Alt right drag.
Add to existing razor selection area	Shift Alt right drag.
Split area item(s) at area edges	Shift left click.
Deselect one part of razor selection	Alt left click.
Deselect entire razor selection	Shift Alt left click.
Delete contents of selected area	Shift Ctrl Alt left click.
Drag/move contents of razor selection	Left drag (Shift left drag to ignore snap).
Drag/copy contents of razor selection	Ctrl left drag (Shift Ctrl left drag to ignore snap).
Move/copy selected area to new track	Drag (move) or Ctrl drag (copy) to below last track.
Move razor selection edges	Left drag either edge (Shift left drag to ignore snap).
Stretch razor selection area	Alt left drag either edge (Shift Alt left drag to ignore snap).
Render razor edit areas using the File, Render command	See Chapter 21.4 . Track and take envelopes and FX are applied. Each razor edit area is rendered as a separate item.
Select all media items within razor edit area	This action can be executed from the actions list, or assigned to a mouse modifier (Razor edit area, left click).

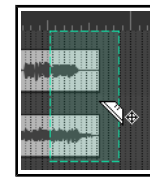

The selected area is enclosed in broken lines, the mouse cursor becomes a razor blade.

Razor edit mouse modifiers and actions

Razor edit mouse modifiers can be customised via **Options, Preferences, Editing behavior, Mouse modifiers**. For example, modifiers can be applied to move an area in one direction (horizontal or vertical) only, or without moving contents, or ignoring envelope type or with or without [ripple editing](#). For Arrange view, Right drag, an action is available to also set the time selection when selecting the razor edit area. See also the **Razor edit area, Razor edit envelope area, Razor edge** and **Arrange view** contexts on the **Mouse Modifiers** page of your **Preferences**. Also, REAPER's [action list](#) includes assignable actions (to shortcut keys and/or toolbars) and/or menus (see also [sections 15.22 and 15.23](#)). Search the **Actions List**. For example, one action allows you to **Create area from cursor to mouse**, another to **Move nearest area edge to edit cursor**. These examples show razor selections involving media items and areas only (i.e. without envelopes or automation items). For [razor selection of automation](#), with or without media items, **Chapter 18**.

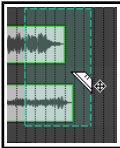
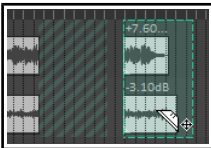
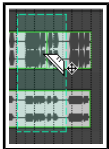
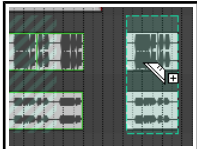
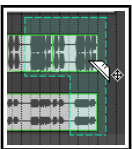
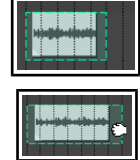
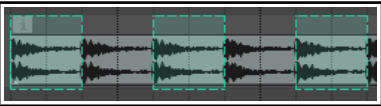
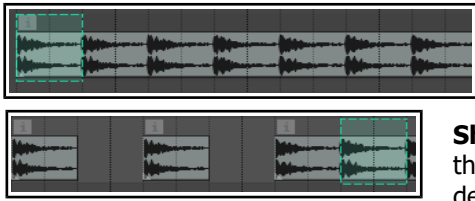
	<p>In this example, Alt right drag has been used to define an area which includes a portion of two media items on two different tracks.</p>		<p>The selected area is being moved to the right using Left drag.</p>
	<p>In this example, Alt right drag is used to define a razor edit selection which spans two media items on two tracks.</p>		<p>Ctrl left drag is used to copy the entire selection as required.</p>
	<p>A razor selection is made using Alt right drag. A further selection is added to it, using Shift Alt right drag. The composite area can be copied or moved as required.</p>		<p>Here Alt left drag is applied to a selected area to stretch the area, in this case stretching it to the right. There is an option (Preferences, Editing behavior) to add stretch markers if you wish.</p>
	<p>Here non contiguous areas are made into a one razor selection using Shift Alt right drag. They can be moved/copied together. Note, however, that if ripple editing is enabled it will be applied whenever a selected area is moved or deleted.</p>		
	<p>Here a sample has been looped for an entire track: we might wish to thin it out, removing every second occurrence. Alt right drag defines the area. Ctrl left click inside the selection moves the selection forward to the next instance. Shift Ctrl Alt left click deletes its contents. Ctrl left click moves the selection forward again, and then again. Shift Ctrl Alt left click deletes again. Ctrl left click moves forward again ... and so on.</p>		

7.3 Power Editing with Mouse Modifier Overrides

You have already encountered several of REAPER's mouse modifiers: these are what gives you the ability to use your mouse to perform so many tasks: for example, when razor editing – **Alt right drag** to make a selection, **Ctrl left drag to copy a selection**, and so on. There's a section dedicated to mouse modifiers in more detail [later in this chapter](#).

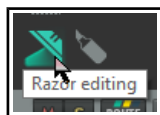

REAPER's mouse modifiers have to handle so many diverse tasks beyond just razor editing that finding your way around them can be a clumsy process. A solution to this is to be able to create your own alternative set of modifiers all relevant to a particular task (in this case razor editing), so that you can focus on that task alone.

By clicking on the razor edit toolbar icon (shown above) you are able to activate an alternative set of arrange view modifiers dedicated specifically to razor editing, all using the left mouse button. The button lights up and becomes animated. You can define the various modifiers as you wish.

Managing and Editing Media Items

7.3.1 Power Editing with Razor Edits

There are four alternative Arrange View sets available (for different types of activity), as explained later in the **Mouse Modifiers** section. Razor editing uses alternative set B. **Options, Preferences, Editing Behavior,**

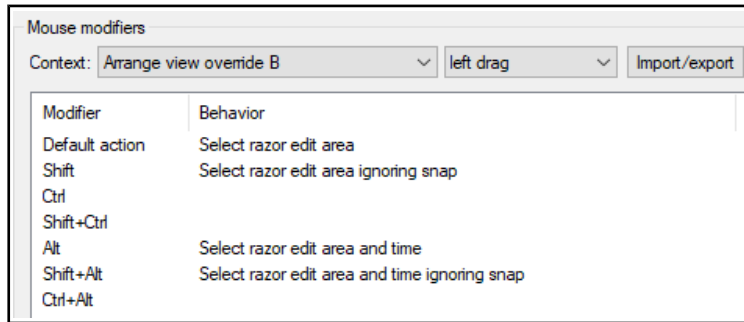

Mouse modifiers, opens the mouse modifiers page. From the **Context** list, select **Arrange view override B**.

As you can see, some tasks have already been defined – for example, **left drag** will **Select the razor edit area**,

You can change any of the default assignments, and/or assign tasks to those that are currently not used. For example, to change **Shift left drag** to **Add to the current selection** you would do this:

1. Double click in the Behavior column in the Ctrl row. This will display a menu of tasks and commands. Click on **Select razor edit area** then **Add to selection**.
2. Click on **Apply**.

Assignments can be made to unassigned modifiers (such as **Ctrl**) in the same way.

One benefit of this is that you can now do all your razor editing without needing to engage the right mouse button.

To remove any of your assignments, double click on it in the Behavior column and select **Default action**.

REAPER's default assignments for other contexts – such as **Razor edit area** will still apply.

For example, **Ctrl left drag** will still move a selected razor edit area. These assignments too can be changed.

To disable the Arrange View B mouse modifiers and restore REAPER's default assignments, simply click the razor editing button on the task bar again. The button will cease to be illuminated or animated.

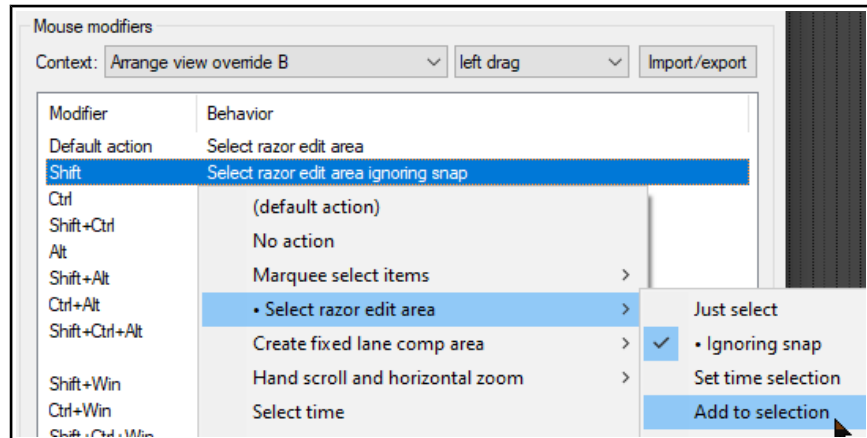

7.3.2 Power Editing with General Editing

Power editing when using marquee is even simpler than

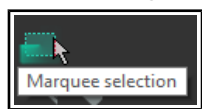

it is for razor editing. Click on the marquee button on the toolbar to activate it. The button will become illuminated and animated.

The various marquee tasks that you have been performing with your right mouse button can now be accomplished using the left button. Choose **Options, Preferences, Mouse Modifiers** and select Arrange view override A if you wish to change any of these.

Also as with Arrange view override B, click on the marquee button again to deactivate it and restore

REAPER's default assignments. The button will cease to be illuminated or animated.

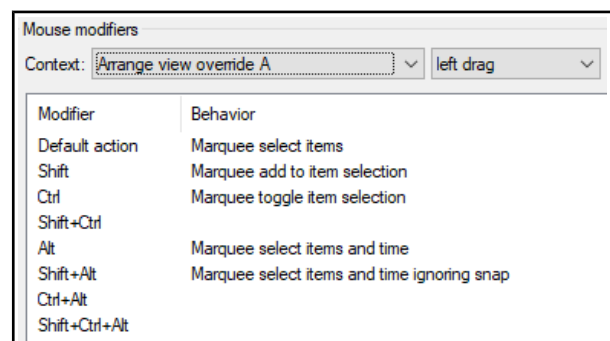

Tip: Even if you prefer not to use these alternative mouse modifiers A and/or B for marquee/razor editing, you might still find them handy. There are many other tasks you can assign them to (e.g. scrolling, scrubbing), in which case they can be activated/deactivated from the **Actions List** and assigned to **toolbar buttons**.

7.4 Auto Trim/Split Items

REAPER's action list contains literally hundreds of commands and actions, many of which are not shown on any menus. **Actions** are covered in more depth in Chapter 15. Two actions worth looking at here are **Item: Auto trim/split items (remove silence)** and **Transient detection sensitivity/threshold (adjust)**. These two can work together. Actions are run by first choosing the **Actions, Show actions list** command from the main menu, then selecting the required action and clicking **Run**. Note both that the Actions menu includes an option to **Show recent actions on menu**, and that within the Actions list you can use the **Filter** box to help find an action.

Auto trim/split items is similar to using dynamic splitting to remove silence, except that it supplies you with some additional options. Selecting an item and running this action opens the dialog box shown here.

Threshold and **Hysteresis** control the noise gate to determine the level below which passages are removed, and the degree of sensitivity applied – the same as with dynamic splitting. Similarly, the controls **Ignore silence...**, **Make non-silent clips no shorter than...**, **Pad** controls and **Auto adjust snap...** all work in the same way as their equivalent dynamic splitting options.

The **Mode** drop-down has four options – **Split and remove silent areas**, **Split and keep silent areas**, **Split only before non-silence** and **Split only before silence**.

If working with a set of grouped items, you have the option to **Split grouped items at times of selected item splits**.

You can also set the gate to be applied post-FX by enabling the option **Run signal through track FX for detection**. This, for example, could be used to avoid chopping off any delay or reverb tails caused by track FX.

If you also run the action **Transient detection sensitivity/threshold** a pair of faint horizontal lines will be displayed to give you visual feedback on your gate settings.

Another option is **Use zero crossings** when splitting. This can prevent audio clicks on playback.

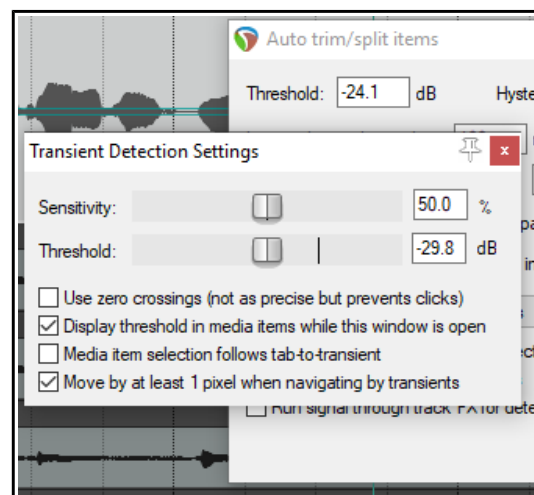
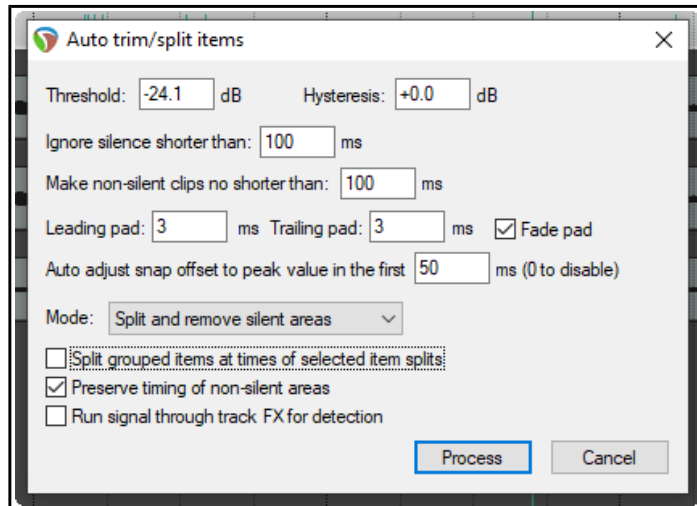

7.5 Media Item Editing with Track Group Items

In Chapter 5 we looked at **track grouping**, including the track grouping matrix. That covered grouping track controls such as volume and pan. Here we are looking at grouping not track controls but media items within and across the tracks, so that an item selection can be edited together. For example, you might want to adjust the item volume handle for a selection of items, or move or copy them together across several tracks.

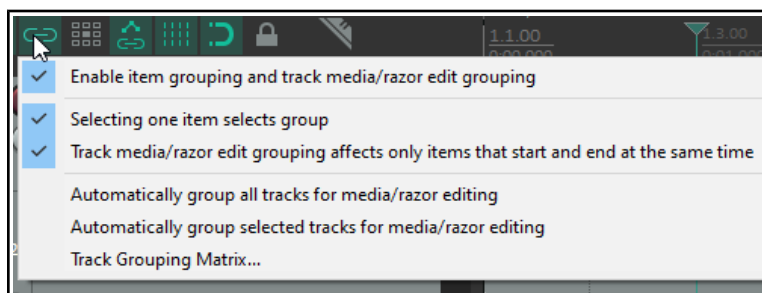

Track item grouping behavior can in part be managed via the item and track media grouping tool on the main toolbar. Right-clicking over this tool displays the menu shown above.

Managing and Editing Media Items

7.5.1 The Item and Track Media/Razor Edit Grouping Toolbar

This section requires you to have a basic working knowledge of both [Track Grouping](#) and [Editing Media Items](#). It looks at working with sometimes complex group selections, often temporary groups. It also examines grouping a number of items across tracks permanently so that (for example) when one item is moved they all move together, or that razor edits can be easily applied to all group members.

You should familiarise yourself with these grouping toolbar options/commands and their meaning:

Enable item grouping and track media/razor edit grouping:

this needs to be set to on whenever you wish to group items for any reason. **Alt Shift G** is a nifty way to toggle it on and off.

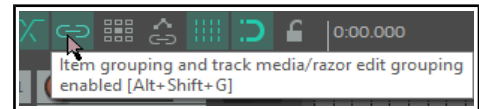

Selecting one item selects group: With this option on you can select all items in a group (defined in the track grouping matrix) by clicking on any one item in the group.

Track media/razor edit grouping affects only items that start and end at the same time: This option is on by default but can be turned off if you need to.

Automatically group all tracks for media/razor editing: With this option on, any razor editing time selection that you make will automatically include media items in all tracks.

Automatically group selected tracks for media/razor editing: With this option on, razor edits or other media editing activity will automatically include all currently selected tracks, including those tracks included in any active track grouping matrix group or groups.

Track grouping matrix ...: This toggle option will open the track grouping matrix if it is not already open, or close it if it is currently open.

We're now going to look at a relatively simple example, without yet employing either the **Track Group Matrix** or another useful tool, the **Track Group Manager**. After that, we'll go on to examine some of the extra benefits available from also using these tools. The examples chosen in this section are solely for the purpose of illustrating how these features can be used and have no other significance.

Note 1: In the examples that follow, which specific instruments/voices are contained in which tracks is not important. The examples have been constructed solely for the purpose of illustration.

Note 2: For convenience and for illustration purposes, this model uses markers and **snap to marker** has been enabled. This is not essential.

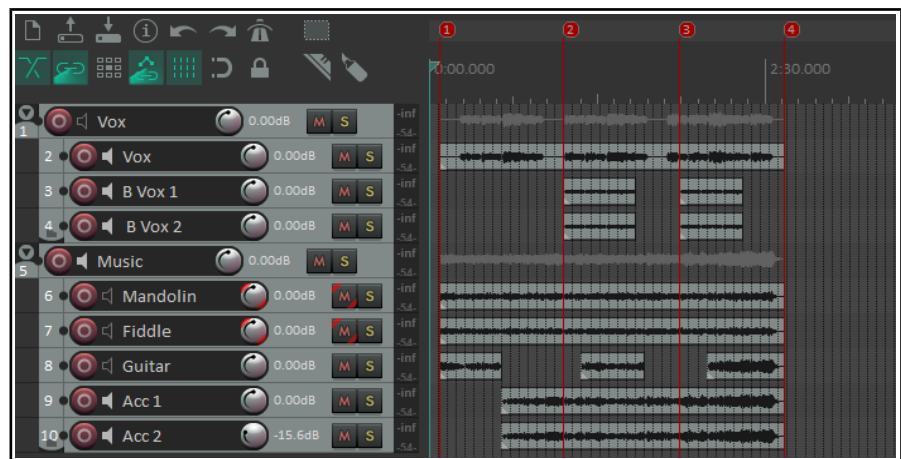

For these examples, we would need to ensure that all group toolbar toggle options except **Automatically group all tracks for media/razor editing** are enabled.

Examples

For the examples that follow, make sure that **Automatically group selected tracks for media/razor editing** is enabled (on the grouping tool).

In this example, we want to copy the contents of tracks 2, 6 and 8 to continue to build the song.

1. In the track control panel, we click on the track 2 media item, then repeat Control click to select each of the media items on tracks 6 and 8 in turn. White highlights will be displayed around the track names.
2. We now simply use Ctrl left drag to drag the media item on track 2 to the right to copy them all to their respective required positions (shown below).

However, what if we regularly need to need to perform editing tasks on these three tracks together? You don't want to be constantly redefining the track selection – especially if your project has many tracks.

The answer lies in track grouping. Instead of what we have just done, we can do this:

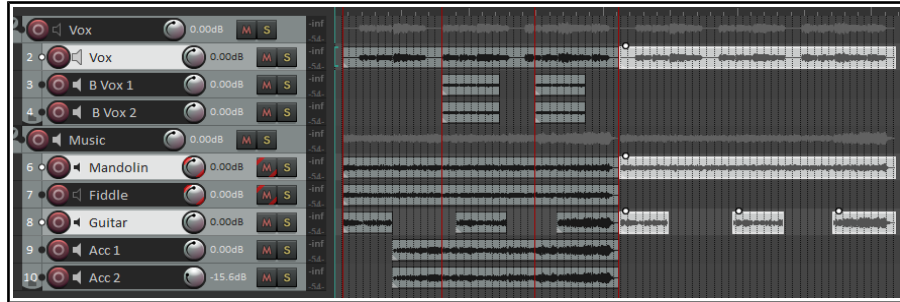

1. To open the **Track Grouping Matrix** we can press **Ctrl Alt G**.
2. We group tracks 2, 6 and 7 and enable **Media/Razor edits** in the first column of this group. As shown here, both tracks are set to Lead/Follow (indicated by the solid black boxes). This will ensure that we can select media items on any of these tracks in order to edit the equivalent items on all tracks in the group.
3. Colored flags will now be displayed for each of these tracks, just inside the right hand edge of the track panel (shown below).
4. We left click on the item on track 2 – as long as **Automatically group selected tracks for media/razor editing** is enabled then the items on tracks 6 and 8 are also selected.
5. Next we use Ctrl left drag to copy the required items.
6. We click anywhere in arrange view to clear the selection.
7. In this simple example we have just two tracks in our group, but remember that this could be a much larger number.
8. We might now encounter the opposite problem from that which we had before – i.e. we might now want to make changes to one media item only, without affecting the other items in the group. This can be done by temporarily disabling the group, in either the **Track Grouping Matrix** or the **Track Group Manager**.

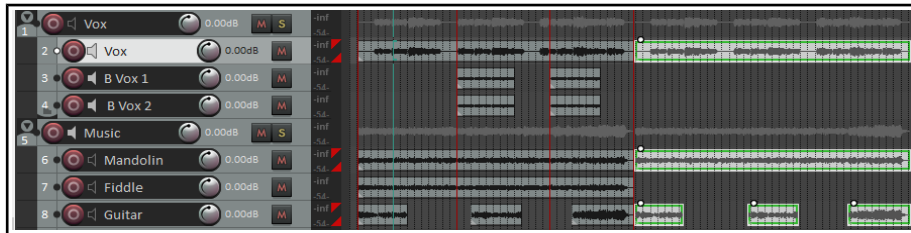
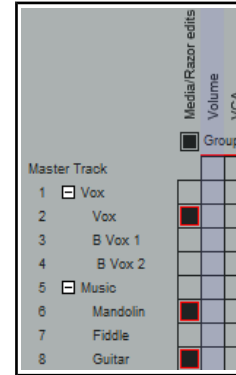

Note: Items grouped for media/razor edits will behave as follows: mouse edits to lead items will affect follow items in the group whether or not they are selected: actions will affect only selected items.

7.5.2 The Track Group Manager

The Track Group Manager is opened from the **View** menu or from a button on the Grouping Matrix.

It lets you manage the groups created in the Grouping Matrix.

Tip: If you have any track(s) enabled for media/razor edits in more than one group then most likely only one of those groups should be enabled at any one time. Otherwise changes made to items on a track in one group could also affect items on other groups. You should also be wary of any hidden tracks that might be included in a group: group edits would include items on those tracks also!

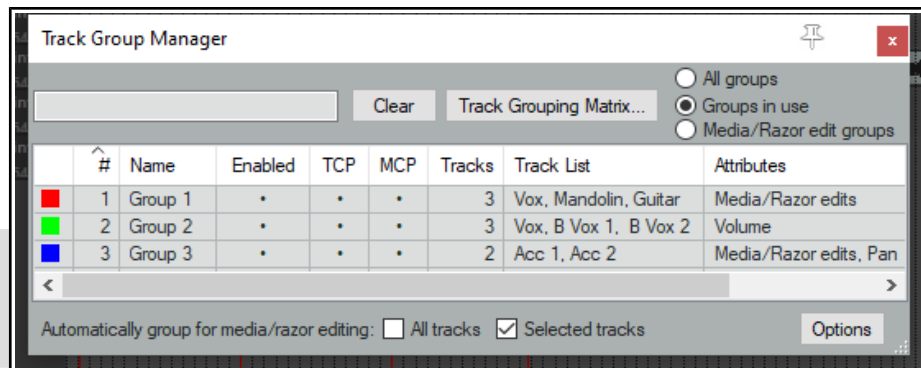

Managing and Editing Media Items

Use this...	To do this ...
Filter Box (top left)	Filter list of groups, by group name, according to whatever text you input.
Clear button	Clear any current filter, makes all groups available.
Track Grouping Matrix	Click this button to open and display the Track Grouping Matrix.
All groups, Groups in use or Media/Razor edit groups	Determine whether to list all groups, only those currently active/enabled, or only those where one or more tracks are active in the Media/Razor edits column.
1st Column	Click to set color, set a random color, or reset color to default.
Name column	Click once to select the group: double-click to rename it.
Enabled column	Toggle group status to enabled/disabled.
TCP	Specify whether to display these tracks in the track panel in arrange view.
MCP	Specify whether to display these tracks in the mixer panel in mixer view.
Tracks	Indicate number of tracks in each group.
Grouped track list	List all tracks in a group. Double click for menu to add tracks to, or remove tracks from, the group.
Group attributes	Lists which controls/features are enabled for the group – e.g. Volume, Pan, Mute, Solo. Double-click to open grouping window to edit group attributes.
Automatically group options	Toggle options to choose whether to automatically group for media/razor editing all tracks in the project, selected tracks only or no tracks. Can be used, for example, to temporarily group all tracks in a file. Note: When automatically group selected tracks is enabled, clicking a media item will change the selection only if that track is not already selected.
Options button	Display menu of toggle options to: Select tracks in group when selecting group Add/remove child tracks when adding/removing parent folder Show track dropdown list nested by folders Dock Track Group Manager window in docker
Sort group list	Double-click on any column header to sort list by that column.
Note: Changes made here are automatically carried over to the Track Grouping Matrix and vice versa.	

Lead/Follow Track Group Edits

When a track group enabled for media/razor edits includes different lead/follow relationships on different tracks then the following applies:

Changes made on items in a lead track will also be applied to the follow tracks. Changes made to a follow track will only be applied to items in other tracks if those tracks are also selected.

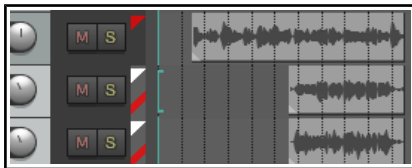

Consider this example (shown above right). Three tracks are grouped. The positioning of the red flags shows that the first of these (at the top of the track's panel) is lead only while the other two (at the bottom of the track's panel) are follow only. If we apply, say, a **fadeout** to an item in the leader track it will be applied to all three.

A **fadeout** applied to an item in the second or third track in the group would, however, be applied to that one item only. However, if you first select both tracks, as shown by the white flags on the left, you could apply the fadeout to either follower track and it would still be applied to both.

7.5.3 Groups, Items and Mouse Modifiers

Where grouped tracks have grouping enabled for media/razor edits then editing actions made to an item in any one of those tracks will generally also be applied to appropriate items on the other group tracks. Appropriate items are those that start and finish within the time bounds of the selected item. Here's an example.

For a bound hard copy of the latest version of this User Guide (printed in B&W) go to LULU.com

Up and Running: A REAPER User Guide v 7.31

Example

These two tracks have been grouped in the track grouping matrix, with grouped media/razor edits enabled. If we select the item on track 6, only the first two of the items on track 7 are also selected, because they are fully enclosed within the bounds of the selected item.

Note: Locked media items within a track group will not be included in track group edits. Lock settings enabled on the toolbar will also restrict track group editing options.

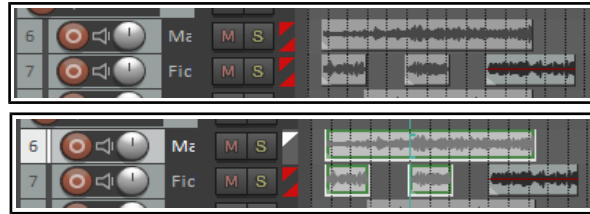

Media Editing Mouse Modifiers

Sometimes you will want a particular mouse editing action to behave differently from normal. Typically this might be to perform an editing action to one media item in a group without affecting other group members. Mouse modifiers can come to your aid by using a booster key (or combination of booster keys), such as Shift or Control. REAPER has literally hundreds of such modifiers, and many are discussed throughout this user guide. There's a [general introduction](#) later in this chapter. Below are listed some commonly used item editing examples. This list is not comprehensive. You can find more at **Options, Preferences, Editing Behavior, Mouse Modifiers**.

Media item, left click

- (default)** Select item and move cursor
- Shift** Add items to selection
- Ctrl** Toggle item selection
- Alt** Select item ignoring grouping

Media item edge, left drag

- (default)** Move edge, relative edge edit
- Ctrl** Move edge ignore group, selection
- Alt** Stretch item

Media item, double click

- (default)** Open item preferences window
- Shift** Set time selection to item
- Ctrl** Set loop points to item

Arrange view, right drag

- (default)** Marquee selected items
- Shift** Marquee, add to selection
- Shift Ctrl** Create fixed lane comp area
- Alt** Select razor edit area
- Shift Alt** Add to razor edit area

Razor edit edge, left drag

- (default)** Move edges
- Alt** Stretch area contents

Track (background area), left drag

- (default)** Select time range
- Shift** Move time selection

Media item, fade/autocrossfade, left drag

- (default)** Move fade, ignoring snap
- Shift** Move crossfade, ignoring snap
- Ctrl** Move fade, no snap, ignore selection
- Ctrl Alt **** Move fade no snap (relative edge edit)

Media item, fade intersection, left drag

- (default)** Move both fades
- Ctrl** Adjust fade lengths, preserve intersection
- Alt** Move fade curves horizontally/vertically

Media item, left drag

- Ctrl** Copy item
- Alt** Move item contents ignoring snap
- Ctrl Alt** Render item to new file

Razor edit area, left click

- Shift** Split media items at area edges
- Shift Ctrl** Create fixed lane comp area
- Alt** Remove one area
- Shift Alt** Remove all areas
- Shift Ctrl Alt** Delete area contents

Razor edit envelope area

- (default)** Move or tilt envelope vertically
- Ctrl** Expand or compress envelope range

Track (background area), left click

- (default)** Deselect all items, move edit cursor
- Shift** Extend time selection

** Allows a fade to be applied to a selection of items whose start and/or end points do not align. With track edit grouping this will only apply if the grouped item lines up with the start/end of the item being edited.

Note that there are many available actions and behaviors that by default are not assigned to any modifier. Double-click in the Preferences, Mouse Modifiers behavior column for any context modifier to explore these.

Track Grouping Actions

REAPER's [Actions List](#) includes several track grouping actions which you can access via the list, or for which you can create your own keyboard shortcuts, toolbar buttons, or menu items. Some examples are shown here:

- Create new track media/razor editing group from selected tracks
- Remove selected tracks from all track media/razor editing groups
- Toggle all track grouping enabled

Managing and Editing Media Items

7.6 Simple Item Grouping

There are likely to be occasions when you won't need the powerful features of [media item editing with track group items](#). If your needs are relatively simple – and especially if you don't need to group items across multiple tracks - there is no need to set up track group relationships in order to group and edit items.

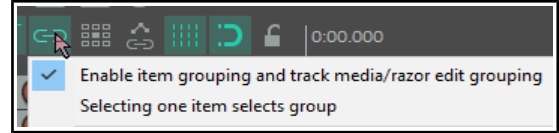

Provided that Grouping is enabled – **Options, Item Grouping Enabled** command, or **Alt Shift G** – items can be grouped together to facilitate working with them. For example, you can move them together, set them all to a common color, mute and unmute them, and so on).

Select the items and use **G** to add them to a group. If you prefer, you can use the **Item grouping** button on the REAPER toolbar to toggle grouping on and off.

In the example shown below, three of the six items have been grouped. For grouped items a **Grouped** icon will be displayed if this has been enabled in [Preferences, Appearance, Media](#). Even when this preference is disabled, you will see a thin colored bar above and below all items that have been grouped (see right).

Further items can be added to a group. Select any item in the group, then press **Ctrl G** to select the entire group.

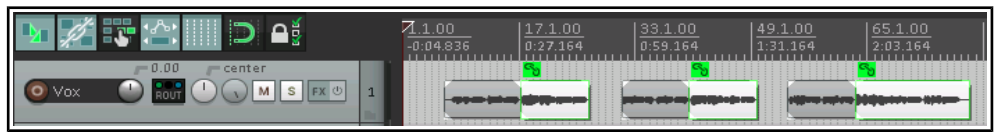

Hold the **Ctrl** key while you click on those items that you wish to add to the group, then release Ctrl and press **G**. Note that **U** removes a selected item from a group. You can also use the **Group** commands on the right click item menu to manage groups.

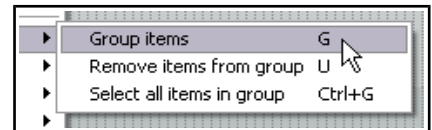

Example

Here is a simple example. **Grouping** is enabled as is **Selecting one item selects group**.



Here are three media items that we want to group. We select all three items and press **G** to group them.



We make some changes to one item (e.g. lower volume, mute) and these changes are applied to all items in the group.

To learn more about item grouping, look at the section [Storing and recalling item groups](#).

Note: Grouped items will behave as follows: mouse edits to one items will affect all items in the group whether or not they are selected: actions will affect only selected items.

7.7 Storing and Recalling Item Groups

Different groups of items can be saved and recalled using the **Item Groups** tab of REAPER's Project Bay. The [Project Bay](#) will be explored in more detail in Chapter 12. For now, notice that you can open it using the **View, Project Media/FX Bay** command, and then select the **Item Groups** tab. To create and save multiple groups, simply use this method:

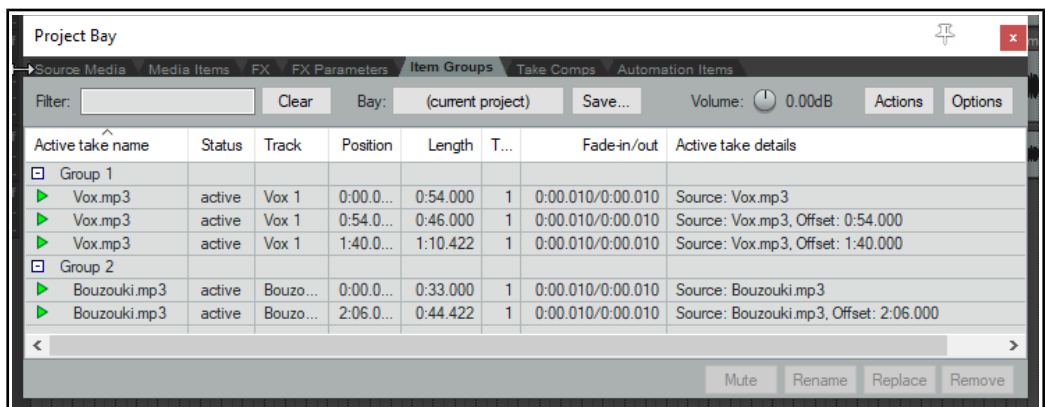

Up and Running: A REAPER User Guide v 7.31

- Open the Project Bay and select the **Item Groups** tab.
- In arrange view, select the items for your first group then right click over one of them and choose **Group** then **Group items** from the menu. A group will automatically be created in the Project Bay. You can right click over the group name and choose **Rename group** to give it your own name.
- Repeat this step to create subsequent groups. The example here shows a project with two item groups.

To select all items in a group, you can now right click over its group name in the project bay and choose **Select group** from the menu. To remove a group, use the **Delete group, keep items** command on the same menu.

Tip: To adjust the volume of all items in a selected group, hold **Ctrl** and **Alt** while adjusting the item volume button or item volume handle of any one of the items in that group.

7.8 Media Item Properties

All media items have a page of property settings which help determine the behavior of that item.

To display an item's properties, select it then press **F2**, or right click and choose **Item Properties**, or click on its properties button (if visible). For audio (but not MIDI) items, you can also double-click on the item to do this. The Media Item Properties box will stay open until you close it. If you leave it open, its contents will reflect the properties of whichever item or items is/are currently selected at any time.

You don't need to understand every one of these properties before you get started, just to know where this information is accessed and changed. The main properties contained within this dialog box are:

- **Position:** can be edited to change the position.
- **Length** of media item (Position and Length: **time, beats, HMSF** or **samples**).
- **Fade In and Fade Out:** you can define both the length and the shape of these. The setting crossfades source media at the loop point but is limited to the amount of source media available.
- **Snap offset:** Offset from the default snap position if snapping is enabled.
- **Item timebase:** Defaults to project timebase but can be changed. Options are **Track/project default, Time, Beats (position, length, rate), Beats (position only),** and **Beats (auto-stretch at tempo changes)**.
- **Item mix:** Effectively whether to replace or mix when an item is placed over another. Defaults to project default.
- **Loop source:** whether item is a loop.
- **Mute status:** mute/unmute item.
- **Item lock status:** whether locked.
- Whether or not to apply **autofades** at item start and end.
- Whether or not to **play all takes** (if two or more takes exist).
- **Active take** file name.
- Active **take name**. By default this is the file name, but you can change this.
- **Pitch** adjustment.
- **Start in source:** sets start time.
- **Playback rate.** For example, type **x2** to double play rate of selected items.

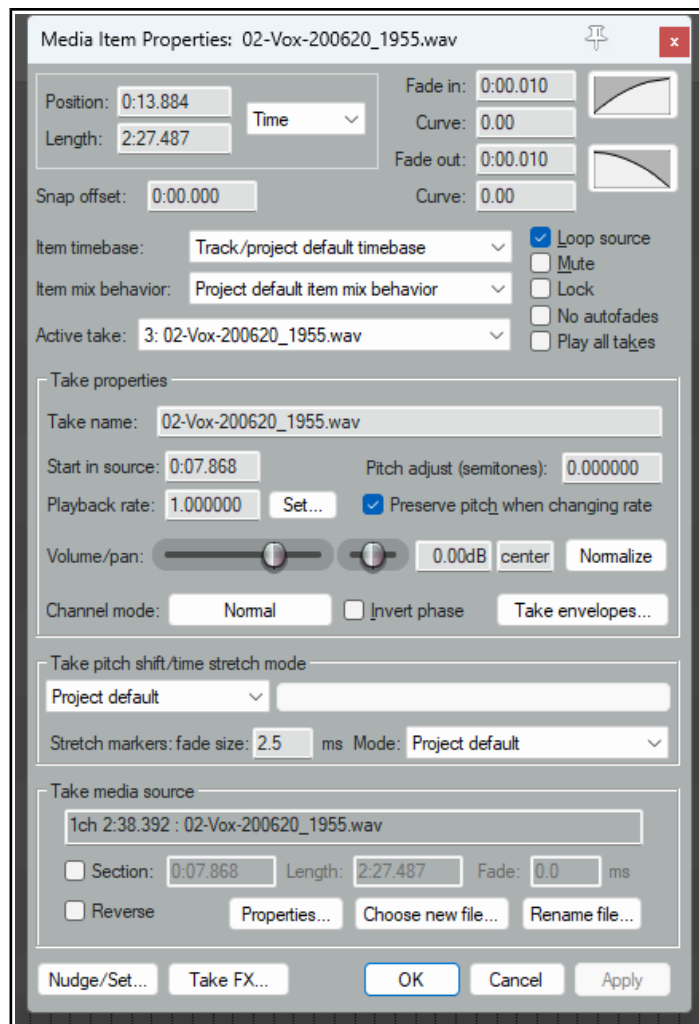

For a bound hard copy of the latest version of this User Guide (printed in B&W) go to LULU.com

Managing and Editing Media Items

- Whether to **preserve item pitch** when the playback rate is changed.
- Adjust **Volume** and/or **Pan**: use faders or type values in edit boxes.
- Option to **Normalize** to **LUFS**, **RMS**, **Peak** or **True Peak**.
- **Channel mode**: discussed [shortly](#).
- Whether to **invert phase**.
- Add or remove **Take envelopes**.
- Which algorithm is to be used for **pitch shift** and **time stretch**.
- **Stretch marker default fade size** and preferred **Mode** (see below right).
- The option to use only a **section** of the media item.
- Options to **reverse** the item.
- Display the media item source file **properties**.
- Choose a **new file** to replace the existing source file.
- **Rename** the source file.
- Access the **Nudge/Set** dialog box for this item.
- Open the **Take FX Chain** window for this take/item.

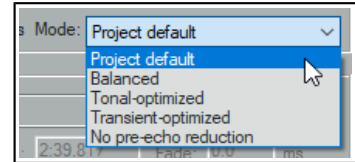

After making any changes, use the **Apply** button to apply them and leave the window open, or **OK** to apply them and close the window, or **Cancel** to close the window without applying changes. There is also an option (right-click on title bar) to **Apply changes after 2 seconds of inactivity** that you can enable if you wish.

Some of these options – such as **Loop Source** and **Channel Mode** (examined later in this chapter)– are also on the **Item Settings** menu. For many of them Keyboard Shortcuts already exist or can be defined. You will be shown how to assign keyboard shortcuts in Chapter 15 when we examine the [Actions List Editor](#).

Tip: To change a property (e.g. playback rate) of several items at once, simply select all of the items then, with one Media Properties window open, make whatever changes you require.

7.9 Media Item Appearance Preferences



Your [Appearance, Media preference](#) settings (Chapter 22) determine how items are displayed in arrange view. Note especially:

Media item labels (including pitch/playrate and gain) can be displayed, within (as shown here, left) or above the media item. You may also show the item pitch/playrate and/or the item gain (if any).

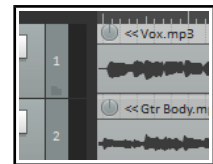

Another feature is **Item volume control**. This is shown by default as a bar which can be dragged up/down to adjust its volume. Hover the mouse over the top edge of the item to display a vertical double-headed arrow (see below). To raise the level above 0.0 dB hold Shift while dragging up.

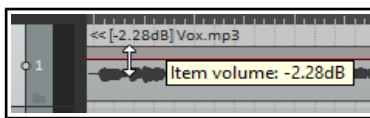

The level can be shown by a line on the top or middle of the media item, or a knob, or both.

Get to know the **Media**

item buttons which can be displayed above the media items. These include the items' locked status, its mute status, show FX, automation, notes and item properties. Buttons can be used, for example, to toggle an item's mute state on and off, or to open its FX chain window.

A **locked** item cannot be moved or deleted, but its properties can be modified.

The **Notes** button opens a window. You can type notes or upload a picture as a background graphic. There are options to use **word wrap**, or display a graphic as a **Centered/tiled image**, **Full height image** or **Stretched image**, or not to display it at all. The window can be left open when focus is elsewhere. There is an option to use the **Enter** key to close the notes window. Multiple notes windows can be left open at the same time. Windows can be resized and open notes window positions will be retained when the file is saved.

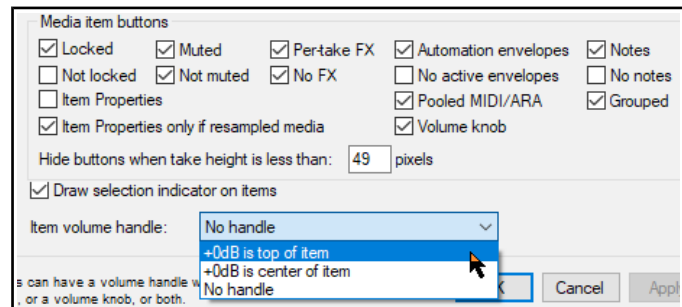

7.10 Editing Behavior Preferences

Familiarise yourself with REAPER's main editing behavior preferences. They are displayed on the [Editing Behavior](#) page of the **Preferences** window, detailed in Chapter 22 (shown right). These include:

- Whether to move the edit cursor when changing time selection, inserting media, razor edit changes, or clicking in fixed lane comping areas.
- Whether to link loop points to time selection.
- Whether to clear loop points and/or time selection on clicking in ruler or arrange area.

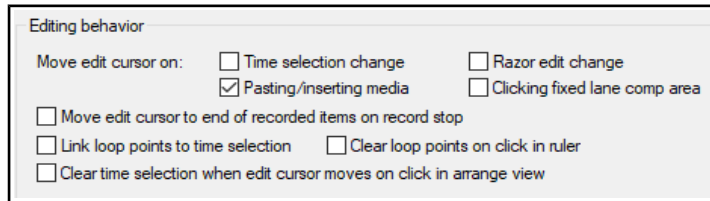

7.11 Overlapping Media Items

Media items can be overlapped by dragging and dropping one over the other.

Crossfades: Automatic cross fades (shown here) are enabled by enabling auto-crossfades on the toolbar. Crossfades can also be adjusted manually and managed using REAPER's [crossfade editor](#), explained later in this chapter.

Offset overlapping media items vertically: This option (**Options** menu) does what it says (see right).

When showing overlapping items vertically stacked, you might wish to check out further options in [Preferences](#), [Appearance](#), [Zoom/Scroll/Offset](#).

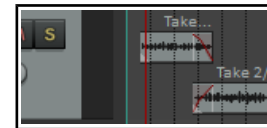
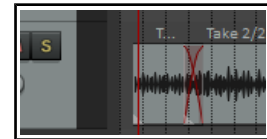

7.12 Separating Loop Selection from Time Selection

If the setting **Link loop points to time selection** (on your [Preferences](#), [Editing Behavior](#) page) is enabled then when you make a new time selection the loop selection changes with it. The toggle command **Loop points linked to time selection** on REAPER's main **Options** menu turns this preference on and off.

With this option disabled, you can define a loop by clicking and dragging along the timeline, and a time selection by clicking and dragging within arrange view. You can use the **Alt** key while you click and drag along the timeline to set both the time selection and the loop selection together.

Note: The [Actions List](#) (chapter 15) include actions to move or copy the contents of a time selection to the cursor position. These are **Time selection: move contents of time selection to edit cursor (moving later items)** and **Time selection: copy contents of time selection to edit cursor (moving later items)**.

7.13 Slip Editing

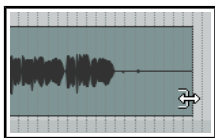

You can slip-edit unwanted passages from the start or end of a media item as follows:

- Hover your mouse over the lower part of an item's left or right edge so that the mouse appears as a double headed horizontal arrow with a square bracket (as shown here).
- Click and drag to the right or left (as appropriate), then release the mouse.

Slip Editing Multiple Items

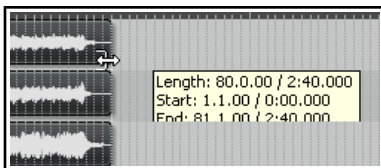

To slip edit several items in different tracks, select all the media items required (for example, hold the **Ctrl** key while clicking in turn on each item, or use the marquee method), then slip edit any selected item. The change will be applied to all items in the selection (see left), relative to their individual positions on the timeline. You can use **Ctrl left drag** if instead of this if you want only one item to be edited.

You can customize REAPER's mouse settings to change the default behaviors. This is done in the media item edge context on the [Mouse Modifiers](#) page of your **Preferences**. This topic is covered in Chapter 15.

Take care when slip-editing adjacent items, especially when they are touching each other. If you click and drag on one of the items so as to create a space between the two, then slip editing will take place in the usual way. However, if you slip edit in such a way as to overlap the items, you will create a crossfade. Both items will be heard when the overlapping portion is played.

Managing and Editing Media Items

This is illustrated here, where the end of the first (further left) of the two adjacent items has been slip-edited to the right, overlapping the other item. This behavior can be modified in two ways. Disabling auto-crossfade (on the toolbar) will stop the crossfade, but both items will still be heard.

Enabling **Trim content behind media items when editing (Options menu)** will ensure that only the slip-edited item (the item on top) will be heard during the overlap.

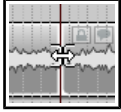
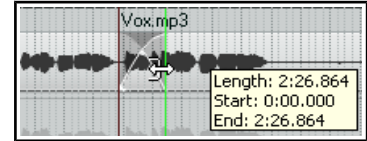

Another technique is to use slip-editing to move the boundary between two adjacent items (perhaps when an original item has been split). Select both items and hover your mouse over the boundary between the items to see the symbol shown here. You can then click and drag left or right to move the boundary.

7.14 Insert Space in Selection

The command **Insert, Empty space at time selection** can be used to create a gap anywhere in a song. Make your time selection before using this command. The space is applied to all tracks (as shown here). Existing material is moved to the right.

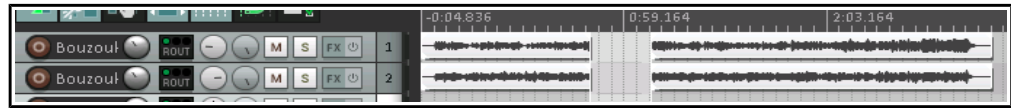
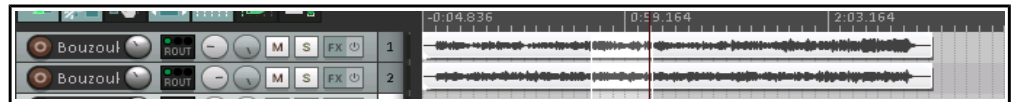

You could then create additional material on any or all tracks in the space that you have opened out.

7.15 Trim Behind When Editing

The toggle command **Options, Trim content behind media items when editing** can be used to ensure that existing material is effectively replaced by any new material that is placed over it.

To understand this feature, let's see what happens when you move one item onto another with "trim behind" disabled and enabled. First, note that trim behind when editing cannot work unless **auto-crossfade** is disabled.

Let's first recall how REAPER behaves with trim behind disabled (the default setting).

1. Shown here are two guitar tracks.
2. We drag and drop the item from the second track over the top of the first.
3. If we now enable free item positioning on the track and increase the track height, by dragging the item on top below the original media item, we can see both the original and the new item stored in this track.



Let's repeat this, but this time with the option **Trim content behind media items when editing** enabled.

Steps one and two would appear to be the same as before. But look what now happens at step 3:

This time, when we allow free item positioning and drag the new item down, there is nothing behind it! The new item replaces the original.



This is only an example. It does not mean that you have to make use of free item positioning if you wish to work with "trim behind" enabled.



Note: When **razor editing**, trimming behind is by default always applied when an item or part of one item is placed over another. To change this, disable **Always trim content behind razor edits** on the **Options** menu.

7.16 Creating and Copying Items in Pencil Mode

REAPER's pencil mode that can be used to create new media items or make copies of existing ones. How the feature works is determined by your **Track left drag** settings on the [Mouse Modifiers](#) page of your **Preferences** window.

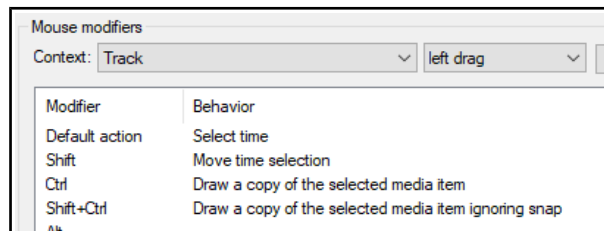

In Chapter 15 you will learn how to change these settings to suit your own needs. For example, you could assign the **Shift** modifier to be used to draw a new item. For now, we will be looking at the default settings. These default settings are shown here.

By default, the following modifiers can be used when clicking and dragging in an empty area in Arrange view:

Ctrl – draws a copy of currently selected media item. Snapping will be applied if enabled.

Ctrl Shift - draws a copy of currently selected media item, will not snap.

Ctrl Alt - draws a copy of currently selected media item pooling MIDI source data with snapping (if enabled).

Shift Ctrl Alt - draws a copy of currently selected media item pooling MIDI source data, will not snap.

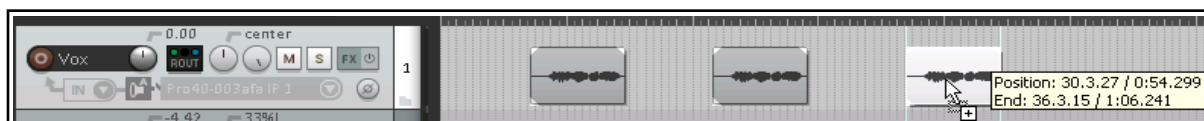

The illustration above is an example of this. The first of two existing media items on a track has been selected. By holding **Ctrl** while clicking and dragging further along that track, a copy of that media item is made.

7.17 Propagating Items

Two media item context menu commands, **Propagate item to similarly named items on track** and **Propagate item to similarly named items** (all tracks), can be used to copy the settings and features of one media item to other items on the same track and which share the same item name. Let's look at two examples:

Example 1

1. In this example, we have imported a sample into our project and placed it on a new track:

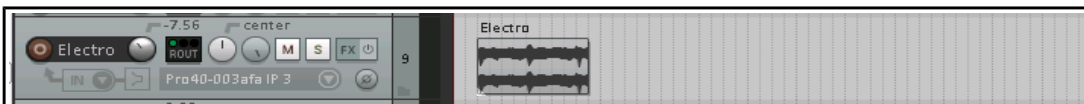

2. Next we have copied it as required across the track:

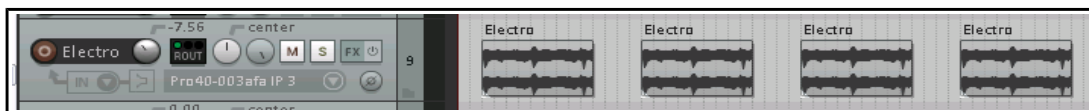

3. Some time later, we decide to make some edits to the first item. These include an adjustment to the item volume handle, some FX, and a fade out.



4. Finally, we right-click over this first item and choose **Item processing, Propagate item to similarly named items on track** to copy these edits to the other items. Any instances of this item on other tracks will not be affected.



Example 2

Managing and Editing Media Items

1. In this next example, the original item has been copied to create several media items across two tracks. Each track has its individual settings, such as different panning and FX on only one item. As well as this, the original media item has its own FX, volume envelope and pitch adjustment.
2. The **Item processing, Propagate item to similarly named items** command has been used copy the features of the original item to all other similarly named items in the project.

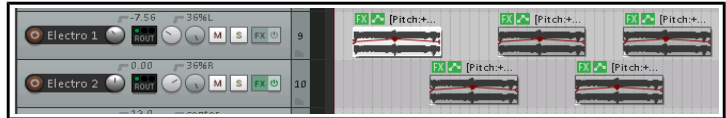
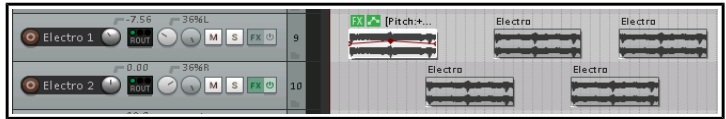

Tip: You can assign one name to several media items all in one go. Select all of the items, press **F2** to open the **Item Properties** dialog box, type the name in the take name edit box and click on **OK**.

7.18 Implode Items To One Track

Where you have built up a number of items that belong together but are spread across several tracks (as shown top right) you can select them all, right-click over any track in the selection and choose **Item processing, Implode items across tracks into items on one track**.



This will move them to a single track (right).



7.19 Ripple Editing

Usually, when you delete part of a media item, a gap is left on the track where the deleted item used to be. With ripple editing, the material on the track is moved over to fill that gap. This is illustrated in the three screen shots below.

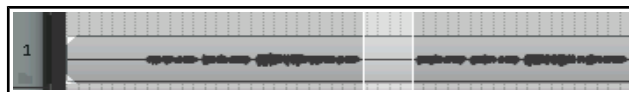
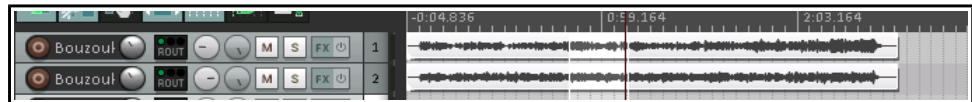

This first picture (left) shows a media item selected with a time selection highlighted.

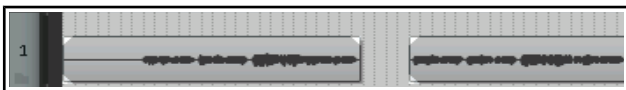

With ripple editing off, deleting the selected area of the selected media item has the effect shown here.

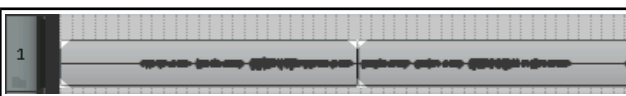

With per track ripple editing enabled, deleting the selected area of the selected media item has the effect shown here.

Two ripple editing options are available on the **Options** menu, or by right-clicking on the ripple edit button on the default toolbar. These are **Ripple edit per track** and **Ripple edit all tracks**. By default, both of these are off. Either one or the other (but not both at the same time) can be turned on from this menu.

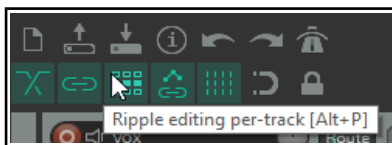

Both off: In this default mode items will not shift when you edit a track.

Ripple edit per track: With this enabled, ripple editing will be applied when you are editing the currently selected track(s) but not to any other.

Ripple edit all tracks: If this is enabled, all tracks will be subject to ripple editing. This means any editing you do to any of the items on any track will also be applied to all other tracks. This can be used, for example, for deleting entire sections of songs.

Up and Running: A REAPER User Guide v 7.31

The keyboard shortcut **Alt P** cycles between the three ripple editing modes, as can the **Ripple Editing** button on the default toolbar. The right-click menu on this button also includes the options **Ripple edit all affects tempo map** and **Add edge points when ripple editing or inserting time**. By default both are disabled.

In this mode, markers and automation are locked to the items that they relate to, so as you move items the associated markers and automation move too. Using this mode on multiple tracks is very useful for editing multitrack recordings of live material - everything that belongs together stays together in sync as you edit.

For instance, if you split the item at a couple of places (so you now have three items) then delete the middle piece, the remaining pieces join up, but unlike with a normal stereo editor, you can adjust the join by dragging the ends of the items appropriately. If you want to move material from one place to another, you can split at the insertion point, drag the material to the right of the insertion out of the way, then make the insertion and drag the displaced material to join it.

All items to the right of the dragged item will stay together and markers and automation will move correctly too.

Below is shown an example with ripple editing on all tracks. Ripple Editing, all tracks is enabled. In the first picture the silence before the music starts is selected. The command **Cut selected area of items** is then applied. The selected area is cut from all tracks, and the remaining material is moved to the project start.



Note 1: Complications can arise if locked items are included in the selection that is to be ripple edited. In particular, REAPER needs to know whether the ripple editing should be applied to the locked items. The [Editing Behavior preferences page](#) includes options for dealing with this – see Chapter 22.

Note 2: Complications can arise when ripple editing if your project includes tempo changes. To ensure that these changes are moved with your material, right click on the ripple edit icon on the toolbar and choose **Ripple edit all affects tempo map**.

Tip: Shortly in this chapter you will be shown how to use **mouse modifiers** to determine how REAPER behaves when an item or selection of items is dragged. This includes options to select and apply any of the three ripple editing states when the item(s) is/are being dragged,

7.20 Trim to Selected Area

To trim a media item or track from both the start and the finish at the same time follow this sequence:

1. Select the media item (or items).
2. Click and drag in the track background area to select the area that you want to keep.
3. Right click over a selected media item and choose **Trim items to selected area**.

If **Ripple Editing** is turned on, the area that is trimmed will also be removed from the timeline, otherwise some empty space will be left. If your **Snap/Grid Settings** are set to include **Media Items**, then provided that snapping is enabled, snapping will be applied when you select the area to be trimmed.

Tip: The action list includes two actions which allow you to click your edit cursor on an item, then trim the item removing either everything before or after the cursor. These are:

Item: Trim items left of cursor, and

Item: Trim items right of cursor

For more information about the Action List see [Chapter 15](#).

7.21 Item Mute and Solo Actions

As well as item buttons, the [actions list](#) (chapter 15) includes several actions for muting or soloing individual items or groups of items. Any of these can be assigned to your own [keyboard shortcuts](#) or [toolbars](#) if you wish.

Item properties: Mute

Item properties: Unmute

Item properties: Toggle mute

Item properties: Unmute all items

Item properties: Solo

Item properties: Unsolo

Item properties: Toggle solo

Item properties: Unsolo all

Item properties: Solo exclusive

(solos item and unsolos any other items already soloed)

Managing and Editing Media Items

7.22 Displaying the Item Ruler

You can display a ruler on individual media items by selecting the item(s) then right-clicking and choosing **Item settings, Display item ruler, Item ruler settings** from the menu. Your options are **Item time, Item H:M:S:F, Item beats (constant time signature), Item beats, Minimal, Source time** or **Source time H:M:S:F**.

There is also an option to display the **Item ruler settings** dialog (shown here). This, for example, allows you to specify a time signature other than the project/source time signature if you wish.

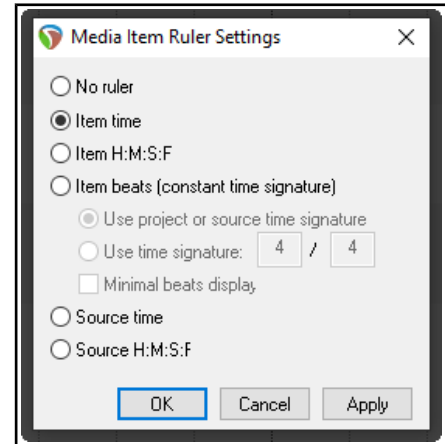
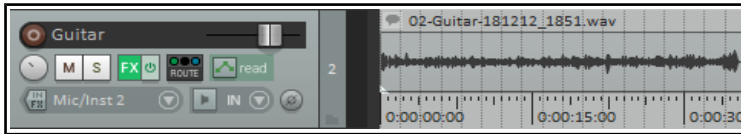

7.23 Take Media Source

The **Take media source** section of the **Media Item Properties** dialog box (F2) can be used to view the properties of the currently selected take, or to change or rename its source file. To change the media item contents click on **Choose New File**, or to rename it use the **Rename File** option.

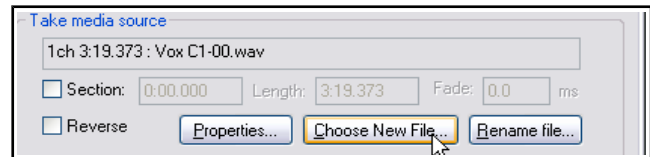

Click on the **Properties** button for information about the source audio file or MIDI item. In the case of MIDI items, you can also modify some properties, such as **Transpose "n" semitones, Only play specified channels, Ignore project tempo, and Chase CC/pitch/program before start offset**.

7.24 Normalizing Items

Normalizing adjusts the volume of an item (or item selection) to a standard level. Select the item(s): from the right-click context menu choose **Item processing** then **Normalize items (Peak/RMS/LUFS)**.

You can optimize to **LUFS-1, RMS-1, Peak, True Peak, LUFS_M max** or **LUFS-S max**, as per [JS Analysis Loudness Meter](#) options.

Normalize as if one long item raises the level of all items relative to each other. At 0.00 dB this will be as far as is possible without clipping. If you **Normalize each item separately** it can be expected to result in a greater increase in volume for some items than for others. With **Normalize to loudest item** is selected the relative volume of media items to each other will stay the same. There is also an option to **Adjust mono media items an additional -3dB**.

Items can also be normalised by clicking the **Normalize** button inside the **Item Properties** dialog. Also, you are able to normalize items or regions when rendering selected media items not through the master via the **File, Render** dialog.

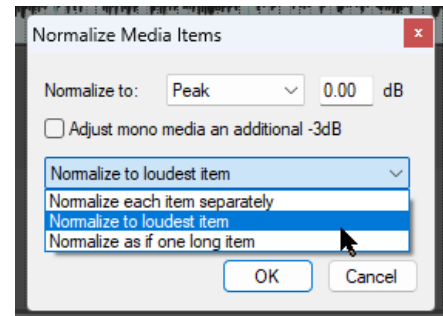

7.25 Snapping with Combined Snap/Grid Settings

You have already learnt (Chapter 5) how to [define grid settings](#) to determine if and how a grid is shown in arrange view. The **Snap/Grid Settings** window (below) lets you ensure that various actions (including time or loop selection) and/or items are automatically snapped into position according to your settings.

Options, Snap/Grid, Snap/Grid Settings open this dialog, or use **Alt L**, or right click on the toolbar Grid button . **Alt S** toggles snap on and off. Grid snapping can be applied in a number of ways, including:

Swing grid: Option to use swing grid, adjusting all or only selected items when changing swing. There is also an option to **Use the same grid division in arrange view and MIDI editor**.

Other options include **Snap media items, selection** and/or **cursor** to selection/markers/ cursor and/or grid, and whether **Grid snap settings follow grid visibility**. Option to **Snap media items to nearby media items** and options to **Snap automation items** and/or **Razor edits** to automation items or media items.

Snap to project sample rate: Items may be snapped to items samples, cursor, markers, loop points and envelope points to snap to samples.

Snap Distance settings enable you to be more flexible. For example, with grid spacing at 50 pixels and snap distance at 5 pixels, the option to **Snap to grid at any distance** off, snapping to grid will occur only within 5 pixels of any grid line. Otherwise, the cursor will be placed wherever the mouse is clicked. Also, snapping can be made **Relative to Grid**.

Note: The snap behavior of ruler markers and regions will follow cursor snap settings.

7.26 Separate Snap and Grid Settings

The above examples use the same set of snap parameters for grid display as is used for snapping. In other words, the snapping would take place to the nearest grid position. Let's now see what we can do if we disable the option **Grid snap settings follow grid visibility**.

We have also changed the **minimum pixels** setting for **grid line spacing**, in this case to 20 pixels, whilst still specifying (at the point where the cursor is shown on the screen shot) a **grid snap spacing** of one sixteenth beats.

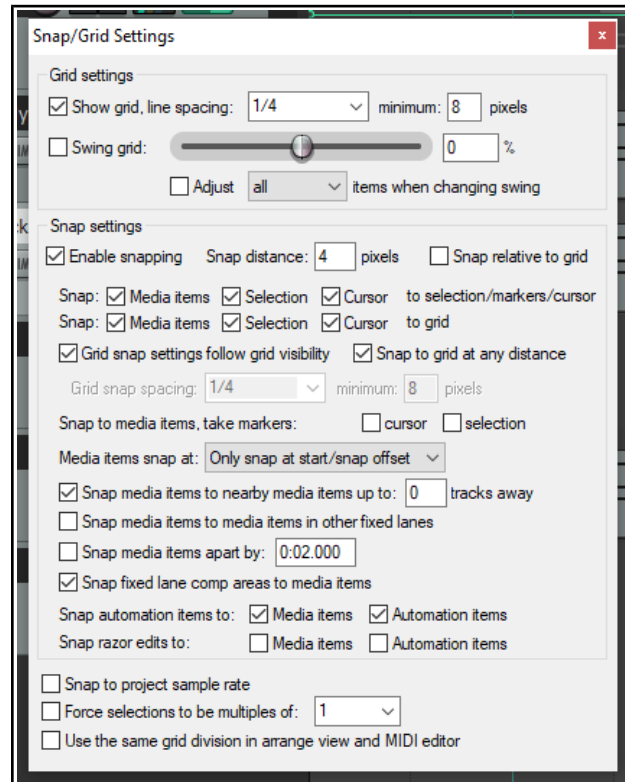
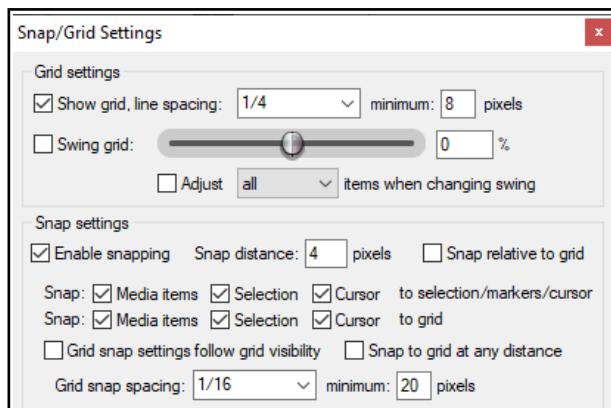

This produces a less cluttered display on the screen. Provided you have zoomed into your project sufficiently, gridlines will be shown for every quarter beat but snapping will take place between as well as on the gridlines, at every sixteenth beat.

The **Media items snap to** option can be set to **Snap both start/end**, **Only snap at start/snap offset** or **Mouse position dependent** (i.e. at the mouse position nearer at the time, the start or the end).

Tip: When snapping is enabled, this can be overridden when selecting a loop along the timeline by holding down the **Ctrl** key while you make the selection.

Note: The [action list](#) includes an action **Item: Set snap offset for item under mouse to mouse position**.

7.27 Free Item Positioning

Free item positioning enables you to move your media items around freely within a track or tracks. This allows, for example, two or more items to play simultaneously or to overlap on the same track:

1. Select the track (or tracks) for which you wish to allow free item positioning.
2. Right click over the Track Control Panel. From the menu, choose **Free item positioning**.



These illustrations demonstrate an example of this. In the first image (left) we have a Lead Vocal and a Harmony Vocal on different tracks. We might find it convenient to place these together on the same track.

In the second image (right) we have enabled Free Item Positioning for the lead vocal track. Notice that there is a small handle (shown by the mouse cursor) which can be



used to adjust the height of this media item.

In the third image (below left) the media item for the harmony vocal has been dragged and dropped into the lead vocal track (with Shift key held down). When this track is played, both media items will play together. In

Managing and Editing Media Items

fact, in this example, the previous harmony vocal track (now empty) can now be deleted.

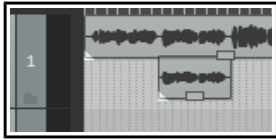

Each item is independent of the other. Either or both can be muted/unmuted, have FX added, and so on. You can use the **Media Item Properties** dialog box (**F2**) or the right-click menu for this.

Note 1: Free item positioning can be made the default for all new tracks by enabling it at **Options, Preferences, Track/Send Defaults**.

Note 2: If auto-crossfade is enabled, media items that overlap vertically will crossfade. Otherwise, the vertical positioning of media items does not affect playback. The *preferences for item mix behavior are ignored*; items always mix on free item positioning tracks.

Tip: As you move items around in free item positioning mode you can sometimes find that items are placed awkwardly or untidily: this can make editing difficult. If this happens, select the items, right-click and choose **Item processing, Auto-reposition items in free item positioning mode**.

7.28 The Nudge/Set Items Window

The **Nudge/set items** window is opened from a media item's right-click menu or from REAPER's **Edit** menu.

In the Actions editor you can assign this action to shortcut keys, and/or use the Menus/Toolbars editor to assign it to a toolbar. Both the [Actions List](#) editor and the [Customize Menus/Toolbars](#) editor are covered in Chapter 15.

This window stays open until closed. You can select any item (or a number of items) to be nudged or moved to a set position. The behavior respects your other settings (e.g. snap and whether the item is loop enabled). The main options and parameters in this window are described in the table below, moving from left to right.

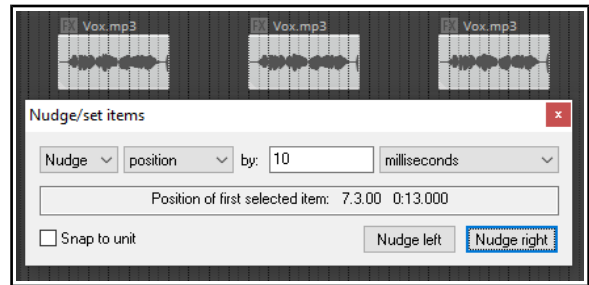

Item	Explanation
Action	Choose Nudge or Set to determine how REAPER will interpret the Unit information. Nudge causes the item to be moved according to the unit specified <i>by</i> the amount specified. In the example above, the item is moved 10 ms left or right (depending on which Nudge button is clicked). Set causes the item to be moved <i>to</i> the position specified.
Unit Value	Determines the number of units by which the item will be nudged. This information needs to be interpreted together with the Unit Type selection. In the example shown above, the unit type is milliseconds and the unit value is 10.
Unit Type	Options include milliseconds, seconds, grid units, measures/beats, samples, frames, pixels, item lengths, item selections and notes. If notes is selected, an additional drop down list offering various fractions of a note (from 1/256 to whole) is also displayed.
Nudge/Set Definition	Determines exactly <i>what</i> will be nudged or set. Your choices are: Position Whole item: the whole item will be physically moved Left Trim The item is trimmed from the left Left Edge/Right Edge The left edge or right edge is moved Contents The item itself remains static, its contents are moved within it Duplicate Creates duplicate item(s) Edit Cursor Moves edit cursor Whether the movement is left or right will depend on which button is clicked. If Duplicate and Nudge are selected, you will be able to specify number of copies.
Snap to Unit	Whether to enable or disable snapping.
Nudge Left Nudge Right	These buttons are displayed only if Nudge is selected. They determine whether to nudge the item(s) to the left or to the right.
Get Cursor Apply Move	These buttons are only displayed when Set is selected. Get Cursor returns the current cursor position and writes it in the "to:" box. Apply Move moves the item according to the various options and settings, including the position specified in the "to:" box.

7.29 Item Channel Mode and Channel Mapping

Select **Channel mode** from a media item's properties dialog to see a menu of options. These include:

- **Normal:** maintains or returns the stereo item to its original channel state.
- **Reverse Stereo:** swaps left and right channels.
- **Mono (Mix L + R):** combines both left and right channels into a single mono channel.
- **Mono (Left):** produces a single mono channel using only the output from the original left channel only.
- **Mono (Right):** produces a single mono channel using the output from the original right channel only.
- **Mono (3-128) or Stereo (1-128):** maps output to a single mono channel or paired stereo channels.

For [multichannel items](#) (see Chapter 3) you may mix down in mono or stereo to channels other than 1 and 2.

2. Item Channel Mapping

The **Channel mode** menu also includes an option **Open channel mapper**. This is also found in the [Actions list](#) and can be assigned a keyboard shortcut. It allows you to map media item output to additional channels (e.g. 3/4) as well as or instead of the default channels 1/2. This can be useful for example:

- ◆ When a track contains several items and you wish to send only some of these items to another track, such as a reverb bus. An example of how to do this is shown below.
- ◆ When mixing in a [surround format](#) such as 5.1 and you wish to send the output to a particular channel or channels.

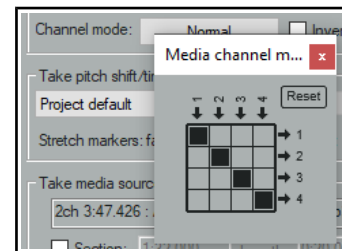

Example

Suppose a track (say, track 2) contains four items, two of which need to be sent to a reverb bus on, say, track 5. Of course, these could be any two tracks.

1. Use the [track routing window](#) to ensure that both tracks (2 and 5) are assigned four channels each, i.e. channels 1-4 (see right)
2. Select the two items in track 2 and press **F2** to open their Item Properties window. Display the channel mode menu and choose **Open channel mapper (changes take effect immediately)**. The display should appear as shown above right. By default, any media on each channel will go to its equivalent output – 1 to 1, 2 to 2, 3 to 3 and 4 to 4. In this case, we want the media on channels 1 and 2 to go to both 1/2 and 3/4. We therefore change pin connector settings as shown here (right). This will also add the **JS: Channel Mapper** plug-in to each of the item's FX chain: this plug-in can be used at any time to adjust any of the channel mapping settings (there's more about this channel mapper in [Chapter 17](#)).
3. Finally, open the track routing window for the Reverb track and add a receive from (in this case) track 2 channels 3/4 to channels 1/2 on this reverb track.

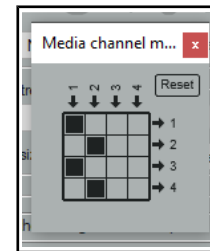

Note: If you make a mistake use the **Reset** button to restore default settings.

7.30 Adjusting Media Item Fades

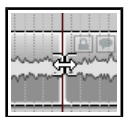

If you select any item in a track and zoom in close enough, you will see a tiny fadeout curve at the end of that item. You can change both the shape and duration of this curve, either using the mouse, or thru the [Item Properties](#) dialog box.



1. Select the rightmost item on one or more tracks. In this example (right) two tracks have been selected. These items might be, but need not be, vertically aligned.
2. Hover your mouse over the vertical white line that marks the start of the fade. The mouse changes to display a curved shape.

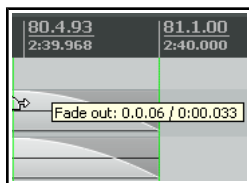

3. Click and hold down the left button. Drag left to increase the fadeout length (see below left) then release the mouse. Notice that the fadeout curve is now more gradual but it keeps its shape.
4. Make sure that your media items are still selected.
5. Right-click over the vertical line that marks the start of the fadeout. A menu of different curves will be displayed (see right). You can select any of these.



Managing and Editing Media Items

Instead of using a mouse, you can use the **Items Properties** dialog box (press **F2**) and make changes there. Also, you can use **Alt left click** to delete a fade, or **Ctrl left click** to cycle thru the different shapes.

The **Options, Preferences** dialog box includes an option on the [Project, Item Fade Defaults](#) screen to specify default fade and crossfade length, overlap, and shape characteristics.

In addition, the Preferences [Mouse Modifiers](#) page (shown right) gives you additional functionality by using modifier keys with your mouse when working with fades and crossfades. Options are available for left click, left drag and double-click.

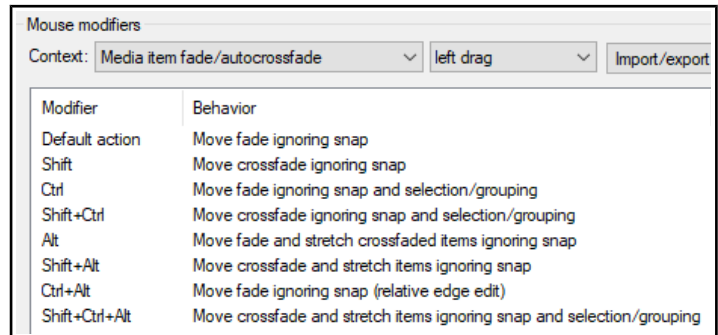

For example, holding **Shift** while dragging the mouse left or right will move a crossfade left or right. **Alt drag** will move and stretch the fade. Other default settings are shown above. These actions can be used on a single media item, or on a selection of media items, and can be customized (see [Chapter 15](#)).

Relative vs Absolute Edge Edits

Unless defined as relative, media item fade edits work in **absolute** mode: this means that within a selection, only those items whose edges align exactly along the timeline will be affected. Actions which work in **relative** mode (e.g. in this context, **Ctrl Alt left drag**) will be applied to all selected items, regardless of where they lie on the project timeline.

In the example shown here (right), relative edge fading is being applied to three tracks by using **Ctrl Alt left drag**. All three are edited, even though their positions do not all align.

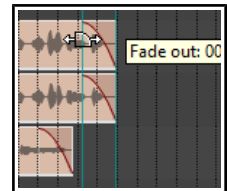

7.31 Crossfades and the Crossfade Editor

Typically, a crossfade is used to transition gradually from one media item on a track to another. In the example shown (right), two media items overlap each other with a crossfade. **Alt X** toggles on and off auto crossfade mode. When enabled, this ensures that dragging the start of one media item over the end of another will automatically create a crossfade. Default crossfade parameters (including **fade and crossfade shapes**) are set in the [Item Fade Defaults](#) page of REAPER's preferences.

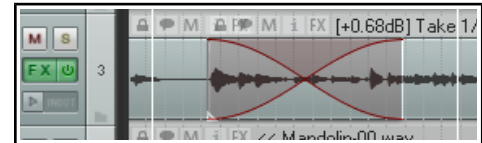

Various crossfade elements (such as shape, start and finish) can be edited with your mouse in much the same way as you might edit a simple fade. In many cases this might be all you need to do. However, if you need it the Crossfade Editor gives you more precise control over the shape and sound of the crossfade. The Crossfade Editor is opened using the **Edit, Crossfade Editor** command or by double-clicking near the top of the crossfade.

On the next page you can see the crossfade editor open. The crossfade area has been selected (by clicking anywhere on the crossfade curve). The crossfade editor displays the fade parameter information for the selected media items.

It might help to use a copy of your project at first, until you become familiar with how the controls work. The following should help you to understand the controls and options and how they can be used:

- The fader **units** can be set to either time (seconds) or beats.
- Any of the seven **shapes** shown can be selected for fade out, fade in, or both. After choosing a shape, you can use the mouse directly on the crossfaded media items. Drag either curve left/right to adjust the fade, or at the intersection to move the point where the fades cross. The dialog box also includes controls used to edit the fades and crossfade (see points below).
- Mouse modifiers can be used to customize mouse behavior (see next page).
- Optionally, you can select **Equal gain** or **Equal power**. **Equal gain** settings include linear fades (the top shape). **Equal power** includes logarithmic fades (second from top). Equal gain might be preferred when both items contain similar material. Equal power might be chosen when the crossfade is between two different types of sound or different instruments.

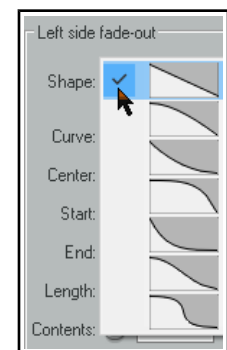

- Adjustable parameters are **curve**, **center** of crossfade, **start** and **end** locations of fade-out and fade-in, **length**, position of **contents** (the crossfade media items), and **volume** of fades. Most of these are self-explanatory. The **curve** setting will adjust the shape of the left, right or (if linked) both curves. Depending on other settings, this may cause the fades' intercept point to move left or right. Note also that when adjusting the **length** you can specify which position should be **preserved** – center, start, or end. The **contents** rotary can be used to move either of the media items left or right. The **volume control** can be used to adjust the volume of the crossfaded items.
- Parameter values can also be typed directly into the edit boxes.
- Left/right values of the different parameters can be **linked** or **mirrored**. Except for **start** and **end**, link and mirror are mutually exclusive options. For example, if **shape** is linked then changing the shape of either fade causes both to be changed in the same way. If mirrored, selecting a shape for one fade causes an opposite shape (if one is available) to be applied to the other fade. If **start** and **end** are linked and mirrored, then adjusting either of these changes the crossfade start and end length equally, keeping the center point constant. If **length** is linked, adjusting the length of either fade changes the length of both fades equally. If mirrored, lengthening one fade causes the other to be shortened by an equal amount. If **contents** are linked, that control moves both media items left or right together. If mirrored, it moves them in opposite directions. If **volume** is linked, adjusting either control raises or lowers the volume of both items together. If mirrored, then raising the volume on one side lowers it on the other.

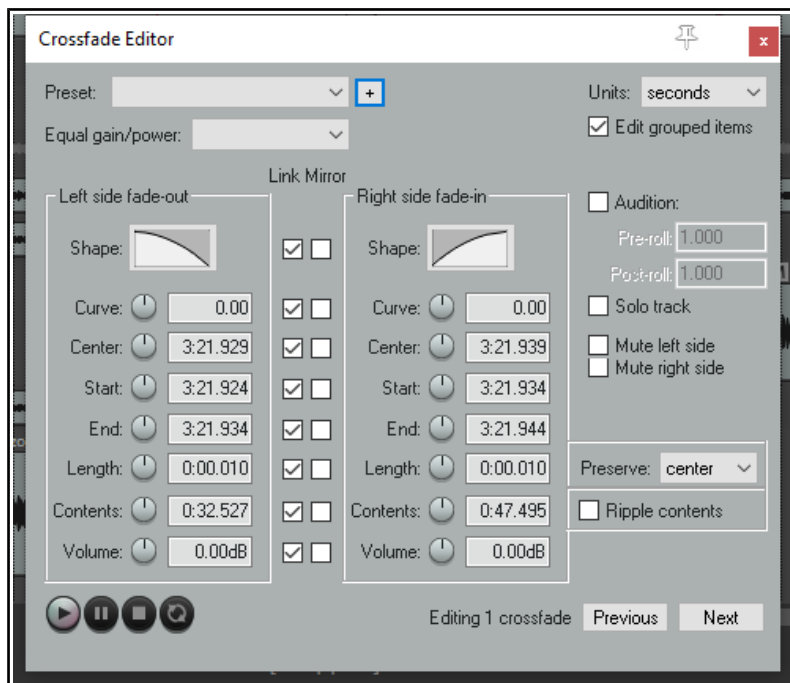

- You can choose whether your edits should apply to all **grouped items**.
- You can **set** the position of **audition** points before and after the crossfade. Enabling audition will cause the crossfaded area (together with the pre-roll and post-roll) to be looped when play on the mini toolbar is engaged. Any other existing loop settings in the project will be retained.

There are also options to **solo** the track and **mute** either left or right side of the crossfade.

- Right-click over the Crossfade Editor for a context menu (right). Options are **Solo tracks**, **Set playback repeat**, **Disable autoscroll**, **Dock crossfade editor in docker**.
- The mini transport bar at the foot of the window can **play**, **pause** and **stop** playback, and enable/disable **loop audition**.
- **Previous** and **Next** select the previous or next crossfade.
- The **+** button (top) can be used to save current crossfade editor settings as a **Preset**. You can include crossfade length within the preset. Saved presets can be recalled from the drop down list to the left of this button.
- If several crossfades are selected, the crossfade editor will by default apply its settings to the entire selection. For mouse edits, this can be changed in your mouse modifiers.

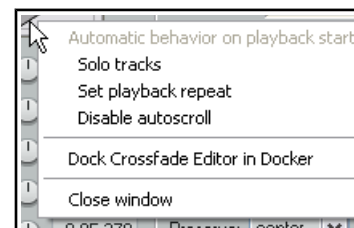

Managing and Editing Media Items

Fade/Crossfade Mouse Modifiers and Actions

Both media item fade intersection and **fade/autocrossfade mouse modifiers** can be defined separately for left click, left drag and double click actions. The left drag modifiers are of particular interest.

The context **Media item fade intersection** is used to apply modifiers to manage the intersection itself.

These can be used with fades or crossfades, e.g., to enable or disable various options, such as whether to ignore snap and/or selection/grouping, whether to stretch items, or to assign actions (such as adjusting the fade curve). Other options enable you to adjust the fade curve with the mouse.

Left click and double click modifiers can be used to apply any of a number of additional fade intersection or auto crossfade actions from

[REAPER's Actions list](#). These include actions to change fade/crossfade shapes, to adjust curves horizontally only or both horizontally and vertically, for managing crossfades on splits and to modify fades in various ways. Search the actions editor for the full list. See also Chapter 15.

Note also that the [Appearance, Fades/Crossfades](#) page of your Preferences includes various options which determine how and when fade/crossfade edit handles are displayed (see Chapter 22).

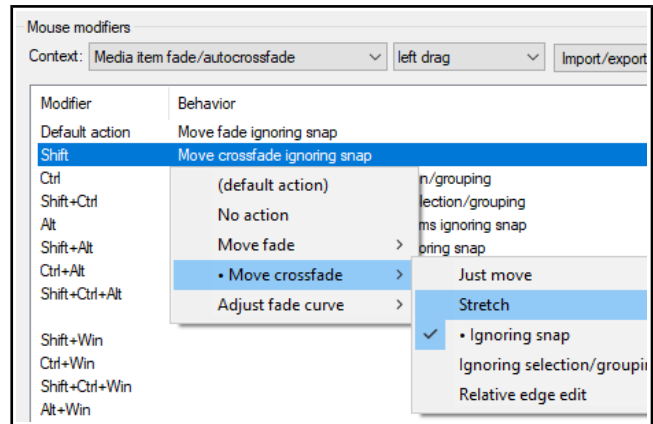

7.32 Calculating Item Loudness

You can open a window displaying information about an item's loudness measurement by running an action to **Calculate loudness of selected items via dry run render** (optionally including take and track FX).

For more about loudness analysis see the [JS Analysis Loudness Meter](#), and for the **Actions List** see [Chapter 15](#).

7.33 Glue Selected Items

A number of items in a track that you wish to permanently treat as one can be joined using the **Glue items** command to create a new media item. The original items are not altered in any way. For example, two MIDI items glued together will automatically and always open together in the same MIDI Editor window. Two glued audio items will now share one common set of Item properties. Items that have been glued together can be later split up any way you wish. This can be useful if you later realise that you need to adjust one or more properties of a portion of a glued item. To glue together a number of adjacent items in a track, follow this procedure:

1. Select the items to be to glued (to do this, right click and drag the mouse across the items).
2. Right click over any item in the selection and choose **Glue items** from the context menu.

Example

In the example shown below, a track is made up of six separate media items (as in the exercise above). By positioning the mouse initially over the first item, then right clicking and dragging to the last item before releasing the mouse, we ensure that all items are selected.

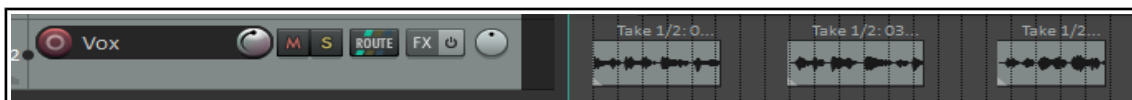

We then right click over any of these items (where the mouse is shown above) and choose **Glue items** from the menu. As a result, the items are joined into one, as shown below.



One application for gluing items is to join several items together into a new loop source. You'll learn more about [working with loops](#) in Chapter 9. Another use for glue is to render an item, for example, incorporating item gain and item take FX into the new media item and setting the FX to bypass. When a selection of two or more items are glued in this way, the FX and so on will be applied to the appropriate sections of the new item.

Note 1: When MIDI items are glued, any item that includes take FX such as a VSTi synth is rendered as audio.

Note 2: Actions are available in the [Actions List](#) (see Chapter 15) to ensure that when an item is glued, its channels will be increased if necessary to accommodate the output of any item FX. For example, if the action **Item: Glue items (auto increase channel count with take FX)** is applied to an item with FX which use two channels for output, then that item will be rendered in stereo (two channels) when glued.

Tip: You can ensure that a period of silence will be added before and/or after the items that are to be glued. For this, there is no need to select the items. Instead, select the track and click/drag in arrange view to enclose the items in a time selection, including any time you require for silence before and/or after the items. Then right-click over the time selection and choose **Glue items within time selection** from the menu.

7.34 Coloring Individual Items

You can change the colors of individual media items (or selections of media items) by first selecting the items and then displaying their context menu and choosing **Item and take colors**, then **Set items to custom color** or **Set items to random colors** or **Set items to one random color**. See also [Track Colors](#) in Chapter 5.

7.35 Customising Mouse Modifiers

You have already encountered many examples of how REAPER uses the mouse with and without modifiers to perform a whole range of tasks. These have so far included making loop and time selections, copying and moving media items, slip editing media items, using item pencil mode, and so on. In [Chapter 15](#), you'll learn more about how you can modify any of these if you wish, and even create your own. Meanwhile, you can find out more about the various Mouse Modifier default settings by browsing thru the [Editing Behavior, Mouse Modifiers](#) section of your REAPER Preferences.

From the **Context** list, select a topic, such as Media item left click, Media item left drag, Track click, Ruler click, Arrange view right-click, etc. A list of default mouse actions relevant to that context will be shown. Double-click on any entry in the Modifier column to assign an action to that modifier.

Shown right are some of the default actions associated with the **Media item left drag** context. For example, by default dragging a media item will move it, ignoring any time selection. Holding **Ctrl** as you do so will copy it – and so on. You can change the behavior of any modifier: select it and double-click in the behavior column for a list of options. For double-click actions, there is also the option of choosing an action from REAPER's [Action List](#).

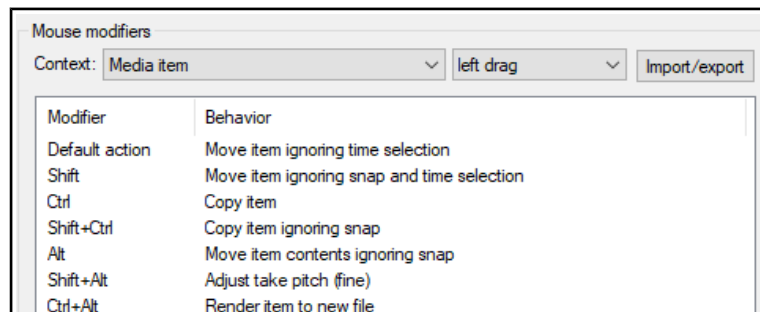

Modifier	Behavior
Default action	Move item ignoring time selection
Shift	Move item ignoring snap and time selection
Ctrl	Copy item
Shift+Ctrl	Copy item ignoring snap
Alt	Move item contents ignoring snap
Shift+Alt	Adjust take pitch (fine)
Ctrl+Alt	Render item to new file

For example, you could define **Shift Win** to restrict item movement to vertical only when moved or copied, and/or **Ctrl Win** for adjusting an item's volume, and so on. To do either of these, you would need to double-click on the modifier in the list, then make your choice from the list of commands and actions offered.

The **Context** drop down list includes the following basic contexts for working with media items.

Media item (left click, left drag and double-click)

Media item bottom half (left click, left drag and double-click)

Media item edge (left drag and double-click)

Media item fade/autocrossfade (left click, left drag and double-click)

Media item fade intersection (left click, left drag and double-click)

Media item stretch marker (left drag, double-click)

Media item stretch marker rate (left drag)

Many contexts have an option associated with them: this will be displayed below the table, just above the **OK** button. In the example above, you have the option whether or not to treat the label area above the item as empty track space.

The **Import/export** button can be used to save or recall your mouse modifier actions, either for the currently selected context or for all contexts.

Managing and Editing Media Items

Media Item Left Click Modifiers

Examples of default mouse behaviors when you click on a media item are:

A simple click will **Select item and move edit cursor**. **Alt Click** will **select the item ignoring grouping**. **Ctrl click** will **Toggle item selection**. See also Preferences, Mouse modifiers, Media item, Left click window.

You can change or swap over any existing assignments, for example so that a simple click will just select the media item without moving the edit cursor. You can also change any assignment to any of the available options. To do this, just double-click in the list on the item that you wish to change, then select your preference from the list. For more information about [customizing mouse modifiers](#) see Chapter 15.

Media Item Double-Click

Some of the default modifiers and actions for this context are shown here (right). Of course, you can change any of these, as you wish.

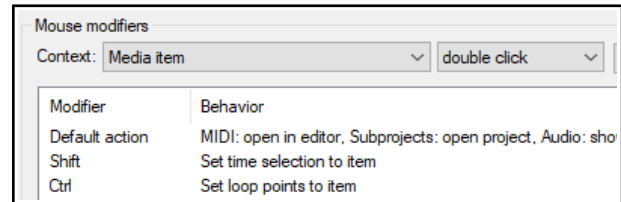

Media Item Edge Left Drag

Shown here (below right) are some of the default mouse modifier settings that are used when clicking and dragging on the edge of any media item(s).

Chapter 15 includes a [step by step example](#) showing how you can change any of these.

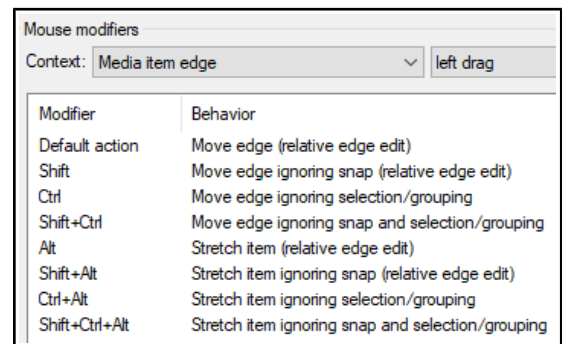

The **Media Item Edge** context pages also include a checkbox option to **Limit edits to source media content for unlooped media items**

Media Item Bottom Half

There are separate mouse modifier contexts available for clicking on the bottom half of media items from those used when clicking on the top part.

Any that modifier behavior that is not defined will automatically follow the behavior for the top half.

Note: When the context **Media item bottom half** is selected, an option is displayed to **Disable targeting of bottom part of media when take height is less than xx pixels**. By default this is set to 44. You will need to change this if you want to use these context actions with media items less than 44 pixels high.

Arrange View Alternative Mouse Modifiers

You might have noticed that there are no mouse modifiers listed for left drag in the arrange view category. This is basically because their actions are "hard-wired" into REAPER for some core tasks, such as:

- Left drag Remove any existing time selection and create new one
- Ctrl Left drag Create empty media item

However, REAPER recognizes that these might not be suitable for your particular workflow. For this reason, you can create up to four alternative sets of arrange view mouse modifiers – A, B, C and D.

By default:

- Set A includes options suitable for use with marquee.
- Set B includes options suitable for use with razor editing.
- Set C can be used when fixed lane comping.
- Set D includes options for making time selections.

You can, of course, change or modify any of these assignments, for example, if you prefer to use them in some other context.

Sets A and B are usually activated/deactivated for marquee (Set A) or razor editing (Set B) from the toolbar.

Set C is usually activated/deactivated from the Fixed Menu Lanes context menu.

There are also individual actions to activate/deactivate all four sets. Probably most useful are the **Toggle arrange view override mouse modifiers {A, B, C or D, as required} on/off**.

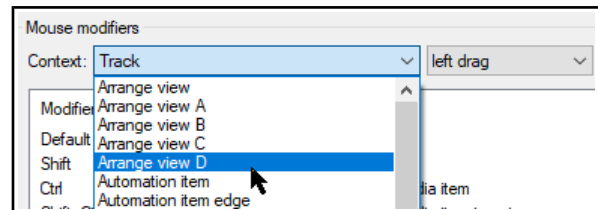

7.36 Dynamic Splitting - Remove Silent Passages

REAPER's Dynamic Splitting has applications beyond tempo based composition, such as to clean up a track and remove any sound from passages that should be silent - for example, with a vocal track, to clean up passages between verses which might contain breathing or shuffling sounds.

With dynamic splitting you can tell REAPER to go thru a take and clean up all the passages where the vocalist isn't singing and you want the take to be silent.

To do this, first select the media item then right click over it and choose **Item processing, Dynamic split items...** . You then need to select the required parameters before splitting.

Each potential split point is indicated by a colored vertical line and those areas marked for removal are shown as darker.

[Dynamic splitting](#) will be examined in more detail in Chapter 9, in the context of tempo based music production, but it can also be used as explained in the table below.

Start with settings similar to those shown here and adjust then as necessary.

When used in this way, dynamic splitting basically employs a noise gate to tell REAPER how often and where to split your media items and which areas are to be removed.

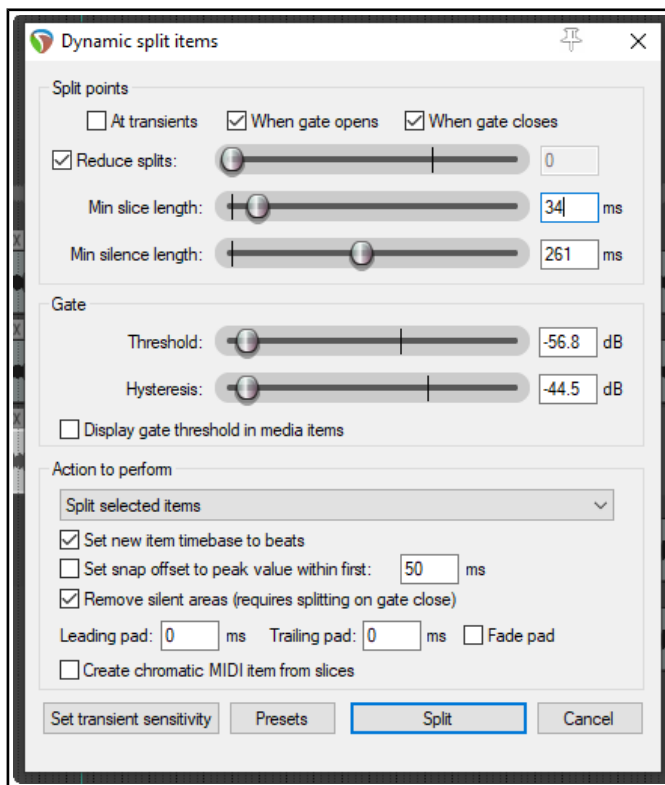

Dynamic Split Option	Setting to Remove Silent Passages
At transients	Deselect this when using dynamic splitting to remove silent passages.
When gate opens When gate closes	You would be unlikely to select one of these options without the other. Both of these options need to be turned on, so that REAPER can work out the beginning and end of each passage that is to be removed.
Reduce split	When using dynamic splitting for this purpose this should usually be deselected.
Min slice length	This sets the shortest length for any slice. You will probably need to experiment to get it right. Usually, this should be set to a low value. Happily, REAPER's dynamic splitting interface gives you immediate visual feedback. You can see by looking at the screen when your settings are right. The illustration below shows the effect of setting this value too high. Notice that it can result in some recorded passages also being removed
Min silence length	This is another parameter that will require fine tuning. Set too high it will fail to catch all the periods of silence,
Threshold	This setting is important, but usually has a reasonable range of acceptable values. If made too low, unwanted sounds might pass thru the noise gate. If set too high, you risk deleting quieter passages of the recorded material. Start around -50dB and make any necessary adjustments from there.
Hysteresis	Used to adjust the level at which the gate closes relative to that at which it opens. Setting this closer to or even above 0dB will create more splits.
Display gate threshold in media items	If enabled, this causes faint lines to be superimposed on the selected media items to show the threshold level.

Managing and Editing Media Items

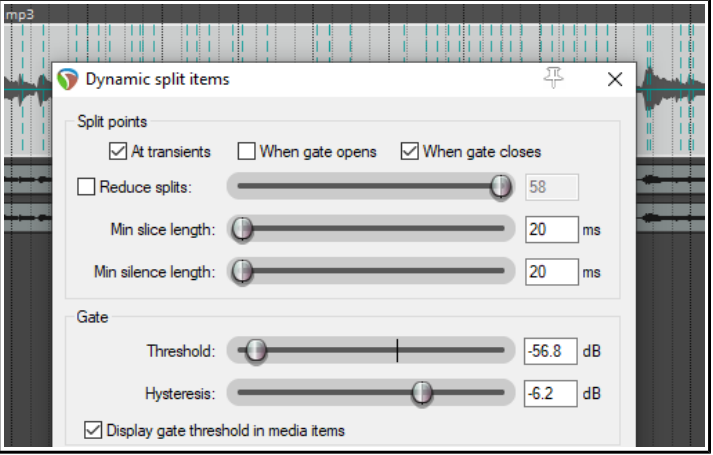
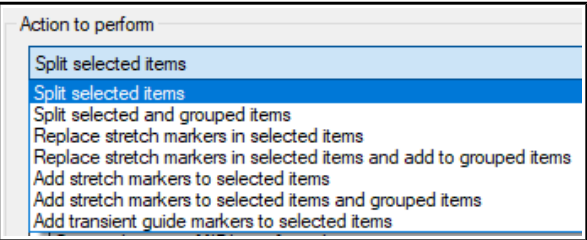
Dynamic Split Option	Setting to Remove Silent Passages	
Remove silent areas	This option should be enabled. Note that when ripple editing is enabled it will be applied as silent passages are removed.	
Fade pads	Enabling fade pads can ensure a smoother transition from/to silence..	
Other settings	Leave them as shown here.	
Presets	Enables you to save and later recall any combinations of settings as presets.	
Action to perform	<p>Split selected items splits only selected items.</p> <p>Split selected and grouped items. Uses the selected item(s) to determine where on the timeline the split will occur. Also splits any other group members.</p> <p>Replace stretch markers in selected items or Replace stretch markers in selected items and add to grouped items.</p> <p>A group of items is defined by selecting them and pressing G, or by choosing Group, Group items from the media item right-click menu.</p> <p>Add stretch markers to selected items, or to selected items and grouped items: stretch markers are explained in Chapter10.</p> <p>Add transient guide markers to items: causes transients guide lines (vertical broken lines) to be added to selected item(s), without splitting themt.</p>	

7.37 Item Peak Display Basics

REAPER's default item waveform peaks display can be adjusted according to your wishes. *Note that any changes you make to the peak display affect only the display, **not** the actual volume of the item.*

To do this ...	You need to do this ...
Increase/decrease peaks height	Click in arrange view, press Shift Up arrow/Shift Down arrow .
Restore any missing peaks	Run action Peaks: Build any missing peaks .
Rebuild all peaks	Run action Peaks: Rebuild all peaks .
Restore original peak heights	Run action Peaks: Reset peaks display zoom for project .
Restore peak height for selected items	Run either Peaks: Rebuild any missing peaks for selected items , or Peaks: Rebuild peaks for selected items .
Note: The actions list includes several more actions related to peaks and peaks display.	

7.38 Normal Peaks and Spectral Peaks: Display Basics

Audio media items in arrange view are normally displayed as waveforms only based on dB levels. You can change this to a spectral display in which the media item is colored according to its audio frequencies, and in particular the most dominant frequency as it changes thru time. An example is shown here (right).

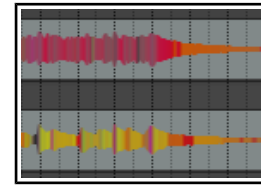

Note that it is a diagnostic tool, designed to help identify and resolve issues in your mix. It is *not* a silver bullet, nor does it offer an instant fix for all your problems. Nor is it intended that your eyes should replace your ears! By viewing your waveforms as a range of colors, you might more readily be able to identify critical frequencies, especially where your ears are already telling you that you have a problem, or at least a decision to make.

Spectral peaks can be helpful in recognizing content. For example, the lower and upper registers of a clarinet will show as different colors. A flute will be different again. Some other possible uses are:

- To identify and pinpoint precisely unwanted noise (such as low end hum), or frequency spikes that you can hear in a track, or a particular event in a track, such as a percussion hit.
- To identify the precise location of a note (e.g. when a distorted guitar has been recorded).
- To check the frequency at which a track's sounds are peaking for possible conflict with other tracks, or to identify precisely where frequencies may need to be EQ'd.
- To check (for example) bass instruments for notes that are too quiet or too loud.

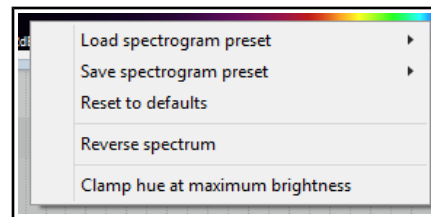

You can learn more about these concepts here

www.mat.ucsb.edu/~b.sturm/MAT201A/presentations/Fri/OhnandPark.pdf:

The command **Options, Peak display mode** gives you eleven options for choosing how peaks are to be displayed, a further option to **Scale peaks by square root (half of range is 12 dBb rather than 6 dBb)**, and the option to open your **Peak Display Settings**. The eleven display options are also available from within the peak display settings window (as shown below),

Use the **Options, Peak display mode, Show spectral peaks** command to turn the display of spectral peaks on and **Options, Peak display mode, Normal peaks** to turn them off. Another peaks display mode option is **Spectrogram**: this will be considered in the next section.

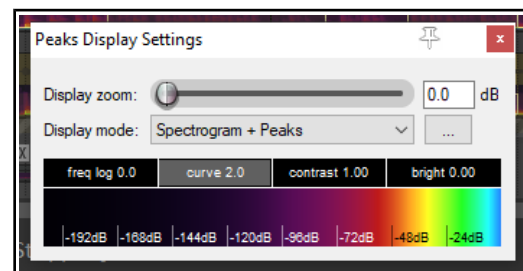

View, Peaks Display Settings opens this window (right).

- **Display mode** modes are shown here (below right). These include Normal Peaks, Spectral Peaks, Momentary loudness and Short term loudness. These last two are explored and explained at the end of this chapter. There are also options to display various permutations, such as Normal Peaks with Momentary Loudness
- There are options to (... menu) **Scale peaks by square root** and to **Open peak generation and caching settings**.
- The **Display gain** slider can be used to increase or decrease the peak height, but do not affect volume.
- In any mode except Peaks, right-click on the color display to open a context menu. Options are available to save, load, rename loudness view presets.

Fade non-tonal content to theme peaks color:

the color of audio that is completely tonal will be determined by the frequency: noise will be the same color as that assigned to the normal peak. In most cases, this will result in a blend of the two.

- In Spectrogram+peaks mode the four horizontal controls **freq log**, **curve**, **contrast**, and **bright** can be used to modify the display – e.g. to emphasise low frequencies, drag the **freq log** fader fully to the right.

Enabling spectral peaks will roughly double peak file size. Generating these peaks uses a lot of RAM, especially if

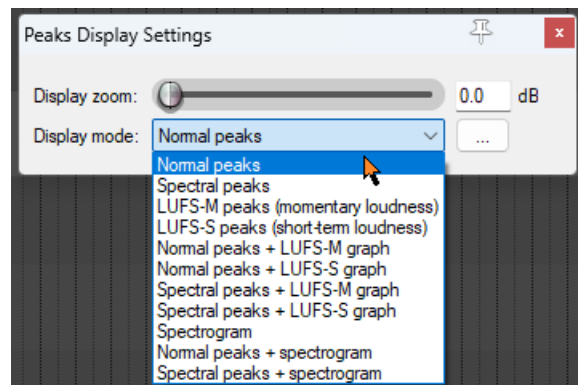

Managing and Editing Media Items

spectral peaks are displayed while recording. Spectral peaks can be enabled/disabled on a per track basis via a [Track performance option](#) (Prevent spectral peaks/spectrograms) on the right-click TCP context menu.

Shown here (right) is an example where Normal peaks + LUFS-M graph has been selected.

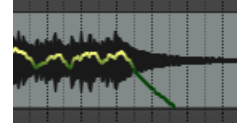

Options on the **Media, Peaks Generation** page of **Preferences** which affect spectral peak behaviour include several options to specify in which circumstances spectral peaks should or should not be generated.

Peak Display Controls

In order to use this tool effectively you will need to understand and master its various controls. For example, if you are focussing on low end rumble you will probably want the display to focus on the lower end of the frequency spectrum. If dealing with high end resonance, you will wish to concentrate on higher frequencies. Here is a summary of the controls available, in many cases by clicking and dragging your mouse. Getting to grips with them all can be a bit tricky at first ... you always have the **Reset to defaults** option!

A media item is made up of a whole range of frequencies (as can be seen, for example, if you place, say, ReaEq in a track's FX chain). Spectral peaks are used to identify only the most dominant frequency at any point in time.

Note that the peak display settings window include sliders that allow you to fine tune both the **opacity** and the **zoom factor** used when displaying the peaks.

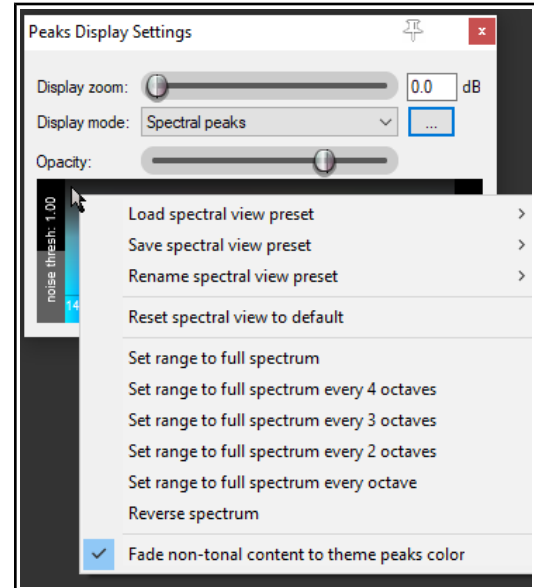

The Frequency Range (20hz to 10khz)

The display is divided into seven frequency bands. To adjust how the **frequency range** is divided between these bands, click and drag the mouse left or right on the border between any two bands. Dragging right helps you focus on higher frequencies, left on lower ones.

To adjust **all colors used** in the display, click and drag left or right over the color display.

To adjust **only low colors**, click and drag on left edge of color display.

To adjust **only high colors**, click and drag on right edge of color display.

Double click to restore the default display.

Presets (right click on graphic display area or click the ... button)

The **Save spectral view** and **Load spectral view** commands allow you to save and recall up to ten configurations as presets. The first five of these can also be loaded using actions (and therefore can be added to custom toolbars and/or menus, and/or be assigned keyboard shortcuts.)

Spectrogram + Peaks Mode

In spectrogram + peaks mode, media items are displayed as both peaks and spectrograms, as shown on the right.

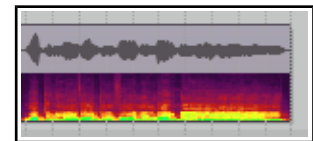

Spectral Peaks Mode

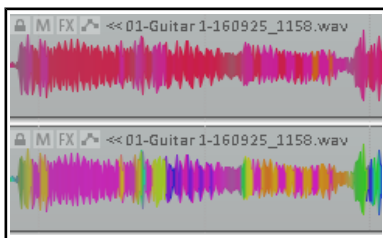

In spectral peaks mode, media item waveforms are colored dynamically according to the dominant frequency.

By default, the color spectrum occupies the whole frequency range. You can change this, for example, to use the entire color range for each individual octave: this can help focus on smaller variations in frequency.

As an example, both of these images (below left) depict the same media item. The first (top) example uses **Set range to full spectrum**. The second example uses **Set range to full spectrum every octave**.

These options are available on the right-click menu above right) as well as a **Reverse spectrum** option.

Monetary Loudness and Short Term Loudness Modes

Loudness modes (LUFS-M and LUFS-S) are a more advanced topic, explained in the last section of this chapter.

Spectrogram Mode

In this mode, media items are displayed as a spectrogram. You can use for spectral editing. The display faders (freq log, curve, contrast and bright) are useful here, especially the **freq log** control. Here is an example:

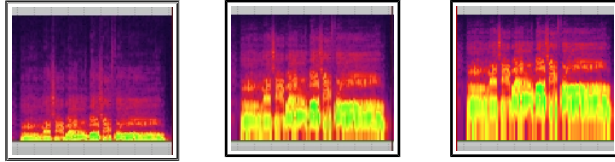

Shown here is the same media item with freq log set to 0.0 (left), 5.0 (center) and 10.0 (right). Notice that in the third image, the lower frequencies take up about half the area of the display.

7.39 Spectrogram View and Spectral Editing

Spectrogram view shows you a visual representation of all of an item's sound frequencies as they vary through time, that is, throughout the length (or duration) of that media item. The most obvious difference between this and spectral peaks is that the latter displays only the dominant frequency as that changes through time.

Spectrogram view can be turned on globally either by choosing **Show spectrogram** from the **Options, Peaks display mode** menu, or by selecting **Spectrogram** from the **Peaks Display Settings** window. This window will be examined in more detail shortly. Using this global option can, however, be resource intensive. You might wish to consider leaving this off, instead turning the option on only for media items as required, by choosing **Spectral edits, Show spectrogram** from the media item's right-click context menu.

Spectral editing allows you to make edits to selected frequencies within an item, for example to remove breathing sounds or sibilance, whilst leaving other frequencies intact. Shortly, we'll look an example of how this can work in practise: first, a summary of its basics.

Defining an area within a media item for spectral editing.

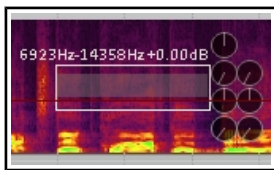

Make a time selection, then right click on the item and from the menu choose **Spectral edits, Add spectral edits to item**. A box will be drawn around the selected area of the item, as shown on the right. Click on the edge of a spectral edit item (or on the shaded bar that runs left to right across its center) to make its rotary controls visible.

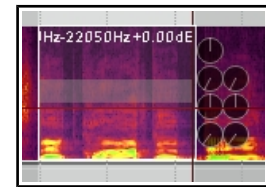

Drag the edges of the box left or right to increase or decrease the time selection. Drag up or down from the top or bottom to increase or decrease the frequency range. This can be done from the sides or the corners. An example of this is shown above left.

Holding down **Ctrl** over any part of an edit item's top or bottom edge changes the mouse cursor into a pencil. You can then make freehand changes to the item area by clicking and dragging. An example of this is shown on the right.

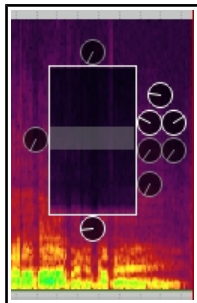

Holding **Alt** over any part of an item's edge changes the mouse cursor to an **X**. You can use this (by dragging) to remove any freehand drawn edges, replacing them automatically with a straight line (or lines).

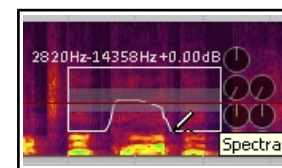

Drag from the center of the item in any direction to move the selected area up or down (change frequency range) and/or left or right (change time selection).

Let's now look at the eight rotary controls that operate on the selected area, located around the box. Moving clockwise from the 12 o'clock position, these are:

High frequency fade: fades up or down the high frequencies. Works in conjunction with the **Spectral region gain** knob.

Spectral region gain: fades up or down the gain level for the selected region.

The next two knobs together act as a **compressor** on the selected area: **threshold (left)** and **ratio (right)**. Moving threshold down to the left of the 12 o'clock position changes it into an expander.

The next two knobs act as a **gate** on the selected area: threshold (left) and floor (right). Below that, the **Spectral region fade out** knob lets you control the rate at which the spectral edit item settings are faded out.

Managing and Editing Media Items

At the bottom is the **Low frequency Fade**: the knob at 9 o'clock controls the rate of spectral edit **fade in**.

All buttons: Right-click over any button (or on the center bar) for a menu of options (below right) which include

Delete spectral edit (removes the spectral edit box, does not delete media).

Bypass spectral edit and **Solo spectral edit** (for comparison purposes).

There is also a submenu to select **FFT size**.

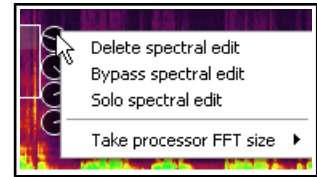

There is also an option in the **Peak Display Settings** to view both the peaks and the spectrogram, in parallel.

Note: Spectral display is pre track FX but post take settings. For example, it reflects changes in pitch from the Item Properties dialog box or from a take pitch envelope, but not from a VST plug-in such as ReaPitch. Also, overlapping spectral edits on the same media item are allowed.

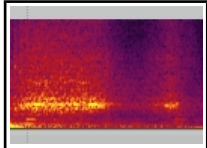

Example

This picture (left) shows the vocal at the end of a line that ends with a "T" sound. The rightmost small shaded area represents an unpleasant "TT" where the singer has not let go of the word. If we mute or remove the whole area, we will create a hole. The trick is to find and remove only the unwanted part.

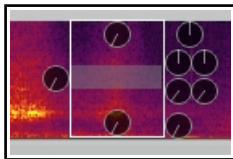

First, add a spectral edit to the problem area.

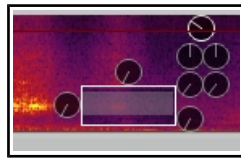

Now adjust area and lower gain until it sounds right.

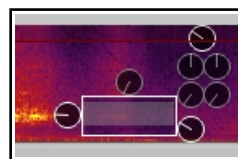

Introduce fades to both time and frequency selections.

Throughout this process, we make use of the **Bypass spectral edit** and **Solo spectral edit** options during playback, for comparison purposes.

Stereo and Multichannel Items

When a spectral edit is added to a stereo or multichannel item separate edit items are added to every channel, each with its own set of controls. By default, these edit items are linked: any change made to one will be made to all.

However, the context menu allows you to select a single channel, thereby leaving the item only on that channel. You can then right-click again (shown right) and copy this item to all or any other channel. Each item can now be independently edited.

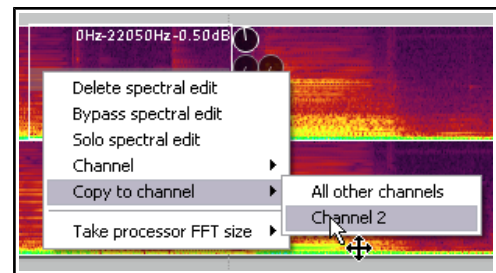

Tip: You can **Glue** items to make your edits permanent and remove the spectral editing box. Glueing creates a new media file but does not remove the original file from your hard drive.

Tip: **Spectrogram display** can be enabled/disabled on a per track basis using the **Track performance options, Prevent spectral peaks/spectrograms** option on the right-click TCP context menu.

Peaks Display Options and Actions

Options, Peaks display mode main menu options include:

Show normal peaks

Show spectral peaks

Show loudness peaks *

Show loudness graph *

Show spectrogram

Show spectrogram and peaks

Scale peaks by square root (toggle)

Rectify peaks (shown right) %%

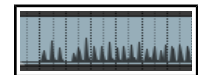

%% Rectify peaks limits display to the top half of the waveform – handy if you have limited track height.

* **Loudness** graph and **Loudness** peaks options are covered in the next section. Note that the **Actions List** includes many actions for peaks management: any of these can be assigned to toolbars, menus or shortcut keys. Of special interest are a series of **Toggle** actions which can be used as a quick and easy way of switching between display options – **spectral peaks, spectrogram, spectrogram and peaks, rectify peaks**, etc.

Using Mouse Modifiers to Create Spectral Edits

You can use **mouse modifiers** (Options, Preferences) to define either or both of the actions **Add spectral edits to one/all channels** to the left drag context for either Media item or Media item bottom half. Assigning one of these to, say, **Ctrl Alt left drag** in the Media item context will give you a quick way to create spectral edits.

7.40 Advanced Features – Loudness Unit Full Scale Modes

For those unfamiliar with LUFS and its use in audio metering there are a number of informative resources accessible online, such as <https://emastered.com/blog/what-are-lufs>. This section will examine how REAPER handles this feature. Those familiar with the [Fletcher-Munson equal-loudness contour](#) will be interested to know that unlike normal peaks, LUFS takes into account psycho acoustics rather than mere decibels. Thus, LFMS can reflect more accurately how the listener will perceive the audio volume.

The distinction between LUFS-S and LUFS-M is that whereas the former, like audio peaks, reports changes in loudness over very short time spans (if not instantly) the latter reports a running average through time, thus producing a smoother curve. Both options are available from the **Options, Peaks display mode** menu and within the **Options, Peaks display mode, Peaks display settings** dialog. An example is shown below.

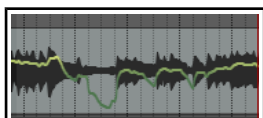

The first illustration (left) displays LUFS-S measurement, so that the graphical display responds quickly to rapid changes in volume. The second illustration displays LUFS-M measurement: such changes are largely evened out.

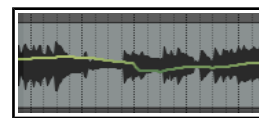

Peaks Display Settings LUFS-M and LUFS-S

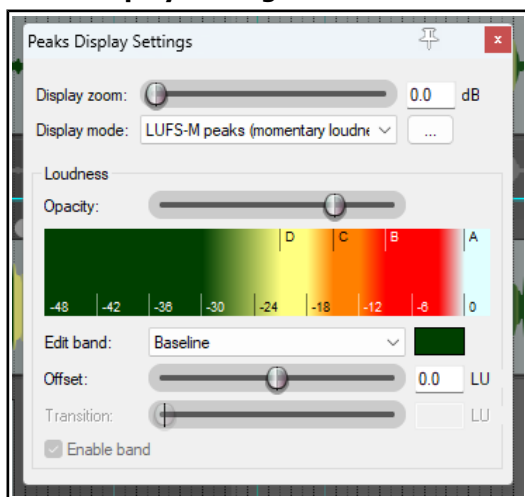

Display zoom (dB): adjusts height of peaks.

Display mode: selects one of the six available display modes, including LUFS-M and LUFS-S. Includes options to show graph.

Opacity (color peaks only): adjusts opacity of the peaks.

The frequency range contains seven bands – a baseline, and six others, A to F. For each band you can specify its color and:

- for bands A to E, the LU value at which the band starts.
- an LU value to determine the rate at which you transition into it (not for baseline, which is assigned an offset LU value).
- whether or not that band is enabled.

The context menu lets you save and name up to 10 **presets** for each view. There are options to **Discard recent edits**, **Reset loudness view to default** and **Reset display preview window zoom/scroll**. REAPER's [Preferences, Appearance](#) settings allow you to enable tooltips displaying peak and loudness values above waveforms (below right).

Presets can also be managed from the ... button menu, along with an option to **Open peaks generation and caching settings** in your preferences.

For spectral peaks the hue is based on the dominant frequency and the saturation is based on the signal's tonality. The more significant the dominant frequency is relative to the whole signal, the more saturated will be the color. Something very noisy will be close to a shade of grey: similarly a sine wave will be a more deeply saturated color.

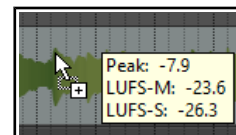

Managing, Comping and Editing Takes

8 Managing, Comping and Editing Takes

In Chapter 3 we saw how to [create multiple takes](#) when recording. In particular, make sure you are familiar with the sections that cover [Displaying multiple takes](#), [Using Color Coded Takes](#) and [Working With Multiple Takes](#). Editing techniques covered in Chapter 7 can be applied to editing a project with multiple takes. You have two main methods at your disposal. You can:

- Explode all takes to new ordinary tracks. You can then work on and edit each track separately and (if you wish) join them all back to a single track when you have finished, *or*
- Explode all takes in place to fixed media item lanes. Fixed media item lanes will be considered from section 8.12 onwards.
- Work on and edit the various takes all within the single track on which they were recorded. We'll get to this method later in this section.

Unless stated otherwise, the examples in this section assume that you have free item positioning and fixed item lanes disabled for your tracks, and in preferences ([Project, Track/Send Defaults](#)). This is the REAPER default.

Note: Most of the images shown in this chapter use the REAPER 5 color theme: the instructions, however, are exactly the same regardless of which theme you are using.

8.1 Using Item FX with Individual Takes

In Chapter 7 you learnt how [FX can be added to individual media items](#). Where multiple takes exist on a track, each take can be assigned its own FX and FX chain. You can insert separate FX plug-ins into individual takes, as shown in the example here. Select the required take, then press **Shift E** to open the take add FX window.

If you have enabled the options **Display media item take name** and **Draw labels above the item** (both under [Preferences, Appearance, Media](#)), then any FX chain for the currently selected take will be included in the information displayed. In the example shown on the right, Take 2 is currently active: the FX names displayed are those FX assigned to Take 2. If you wish, you can insert the same FX into each take and apply different parameter settings for each one.

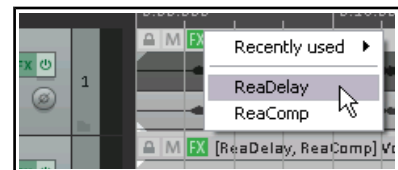

8.2 Exploding Takes to Multiple Tracks

We'll start by looking at the first of these two methods. Let's suppose that we have recorded three takes of a vocal track. We can right click over the item and use the **Take, Explode all takes to new tracks** command.

This command creates (in this case) three extra as yet unnamed tracks – the original track with its three takes is still intact. Now suppose that after auditioning we have decided which parts we want to use from each take. In the next illustration, we have edited the various takes to leave only the portion of each take that we wish to keep. This

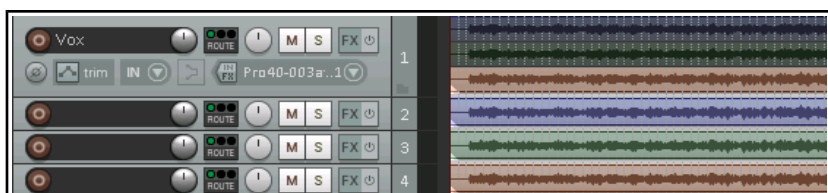

has been done using various editing techniques that have been covered in Chapter 7.

Finally, we select the various items from tracks 3 and 4 and use the **Num Lock 8** key to move them up to track 2. Track 1 is now muted and could of course be hidden. Tracks 3 and 4 could be deleted. You could now select all of the items in track 2 and use the **Glue Items** command to bind them together as one media item. Note that the

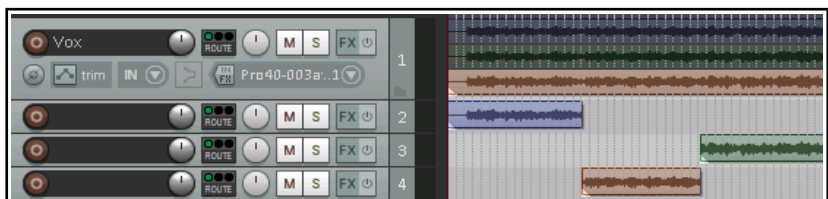

original muted track with the three takes on it is still available. This makes it easy at some later time for us to change our mind about what to include in the vocal track if we wish.

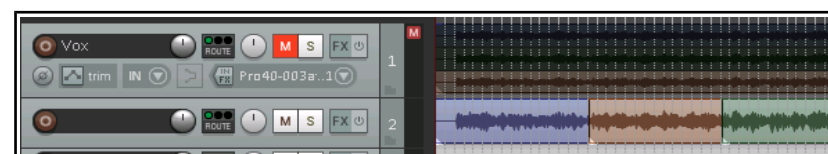

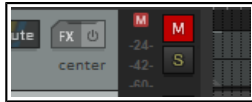

Note: If you are using the REAPER 6 color theme default layout, the mute button is located on the top right corner of the track panel, as shown here.

8.3 Crossfades with Takes

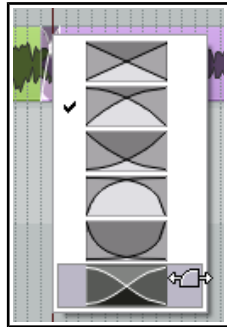

If you intend to arrange your media items so that they overlap, then you should first decide whether or not you want REAPER to add a crossfade.

This feature is turned on and off using the **Auto Crossfade** button on the main toolbar (or the keyboard shortcut, **Alt X**).

The curves of crossfades can be edited. You can extend the crossfade in either direction by dragging the vertical fade bars. If you hold **Shift** while doing this, you can move the crossfade itself left or right to a new position. Right-clicking over the crossfade reveals a menu of different crossfade shape options (see left). Using these techniques can ensure that an otherwise abrupt edit is made into a gradual transition at the best edit point.

Various options are available to you for customizing mouse behavior when crossfade editing. These can be selected from the [Editing Behavior, Mouse Modifiers](#) page of your Preferences – see also Chapter 15. An example of this shown here. For more advanced

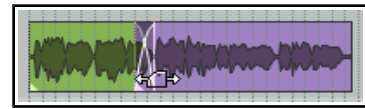

crossfade editing, you might wish to use the [Crossfade Editor](#) (see Chapter 7)

8.4 Exploding Takes in Place

Another option is to use the **Take, Explode all takes (in place)** command. This has the effect of merging all takes on the track into a single lane. Here's an example of when you might wish to do this. The track shown here includes three lead vocal takes. You have made your selection of the best parts of each take. These have

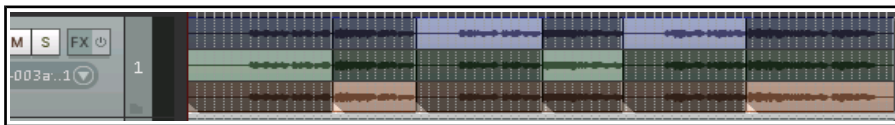

had their individual item properties (such as volume) adjusted to give you the sound that you want.

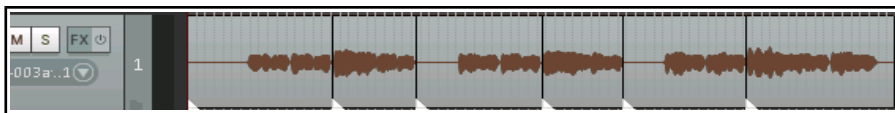

By exploding all takes in place, the selected items are placed over the other takes in a single lane.

8.5 Play All Takes

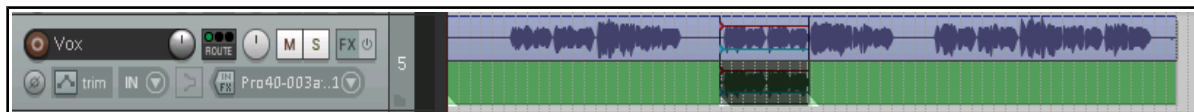

Here's a really interesting trick you can do with takes. Shown here is a vocal track with an overdubbed vocal harmony for just a short part. Both takes at that point have had individual pan and volume envelopes added, and some delay and perhaps pitch shift FX to the second take's FX chain.

After selecting both these media items, right-click over either one of them and choose **Item settings** then **Play all takes**. We can thus have our complete vocal and harmony mix on one single track! This setting is also available from within the Item Properties window.

8.6 Editing and Comping Multiple Takes and Multiple Tracks

You don't need to explode takes to multiple tracks in order to manage them. In this section we'll see some of the ways in which you can manage your takes all within a single track. In overview, this essentially consists of selecting the best parts of each take and comping them together into a single take of your preferred selections.

Slice and Dice

When you choose the **Option to Show all takes (when room)** there is a neat technique known as *slice and dice* that helps you combine the best of each take together, to play as one track. To do this, you simply **Split** the track in as many places (and at the exact points) that you think appropriate, then select from each slice your preferred section. The different [methods that you can use for splitting](#) are explained in Chapter 7.

Managing, Comping and Editing Takes

A clever trick is to make all of the items that together make up a complete set of preferred takes a different color from the others. To do this, first choose your takes and select all of the media items (use marquee to do this), then choose from the right-click menu **Item and take colors**, then **Set active take to custom color** or **Set active take to one random color**. These commands are also available from the media item right-click context menu. An example of how this can be used is shown below.

Suppose that one of these takes consists of an overdub of just a small portion of the song. The option to **Display empty takes** (**Options, Take behavior** menu) can be enabled to ensure that your takes are displayed more clearly. An empty part of a take (such as exist in Take 2 here) cannot be selected unless you enable **Allow selecting empty takes** (**Options, Take behavior** menu).

Note 1: If you prefer not to see the empty takes, you can hide them by disabling **Display empty takes** (**Options, Take behavior** menu).

Note 2: When using "slice and dice" with MIDI takes, you should disable the option Allow trim of MIDI items (Preferences, Media, MIDI), especially if you will need to adjust split positions.

Composite Take (Comp) Sets

Any sliced and diced item (as shown above), or selection of such items (as shown right) can be saved as a composite take (comp), and recalled later if required. You can create and save multiple comps for such items.

You can save multiple comp sets for individual tracks (as shown above) and for multiple tracks (as shown right), where two tracks have been sliced and diced differently.

With all media items in this set selected (use marquee), you can right-click over the selection and choose **Comps** then **Save as new comp** from the context menu. You will be prompted for a name: this will be added to the Comps menu and can be used to recall this comp. This makes it easier for you to compare different take combinations.

Saved comp sets can be applied by selecting the media items (all takes) of the relevant tracks in arrange view, then right clicking over the selection and choosing **Comps** then the comp name from the context menu. Here is a summary of the commands on the **Comps** sub-menu.

Command	Explanation
Save as new comp	Saves your current selection of takes on all currently selected tracks as a new comp set. You will be prompted for a name.
Rename active comp	Lets you change the name of current active comp set.
Remove active comp	Deletes selected comp set and removes it from the Comps menu. Does not remove any takes or media items from the project itself.
Crop list to active comp	Removes other comp sets from comps menu list.
Move active comp to the top	Moves all items in take selection to the top of its track. This action respects both item grouping and undo.
Comp names	Your comps will be listed at the end of the Comps menu (see example right). Choosing any of these will cause that set of takes to be selected.

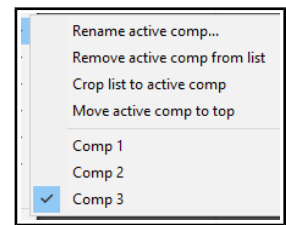

Up and Running: A REAPER User Guide v 7.31

In this example, we have created a second comp set and colored it green. We can now switch between comp sets at will.

Below right, with our preferred comp set selected we use the command **Move active comp to top**. Don't forget also that by pressing **Ctrl L** you can toggle the display of vertically stacked takes on and off, as shown below.

Tip: When you slice and dice lanes in this way, you can use the **Num Pad** keys 1 and 3 to slide items left or right if their timing is slightly out of sync. The exact amount by which these keys will slide your selected media item(s) will depend on how closely you are zoomed in or out.

In the earlier stages of post production you might want to use comp sets for individual tracks rather than for groups of tracks. This gives you a more flexibility in "mixing and matching" your various tracks together. Note also that comps are preserved when items are split. Moreover, as your mix progresses towards its completion, you may find that it more advantageous to save comped sets for whole selections of tracks, so that they can be recalled and used together.



Take Behavior Options

Note the three take behavior toggle options on the **Options** menu. These are mostly self-explanatory:

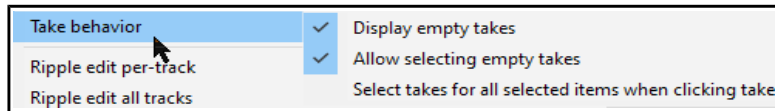

Display empty takes, Allow

selecting empty takes and **Select takes for all selected items when clicking takes**. Disabling this last option allows you to work with takes on individual tracks within a track selection without losing the selection.



8.7 Take Menu Command Summary

The table below summarizes other **Take** menu management commands that are available to you:

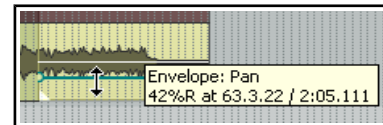
Command (Shortcut)	Explanation
Next take (T)	Makes next take the active take for all selected media items.
Previous take (Shift T)	Makes previous take the active take for all selected media items.
Delete active take (X)	Deletes currently selected take on all currently selected media items.
Crop to active take (Alt Shift T)	Removes all non-active takes from currently selected media items.
Duplicate active take	Adds a copy of the active take to the item as a new take.
Lock to active take (toggle)	Locks the current active take selection. When locked, a take cannot be changed unless this toggle is used to unlock it.
Show FX chain for active take	Opens FX browser to allow you to add FX to the active take.
Remove FX for active take	Removes FX previously added to a take's FX chain.
Take envelopes...	Opens a window from which you can choose to add a volume, pan, mute and/or pitch, and/or any take FX parameter automation envelope . (see Chapter 18)
Take markers	See section later in this chapter .
Explode all takes to new tracks	Copies each take to a new track.
Explode all takes in place	Places takes on top of each other, so that all will play at once.

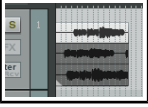
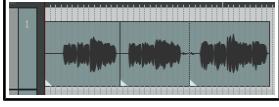
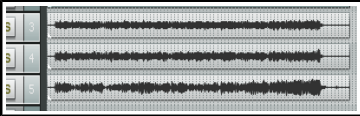
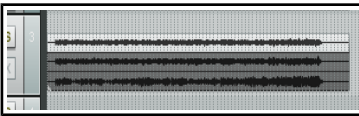
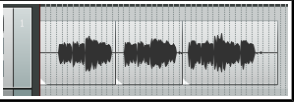

Managing, Comping and Editing Takes

Command (Shortcut)	Explanation
Explode all takes (in order)	Places selected takes on the same track in sequence. This command turns this ... into this:  
Implode items across tracks into takes:	Copies all selected items to a single track as a series of takes. This command turns this into this:  
Implode items on same track into takes:	Moves all selected items to the same start time as a series of takes on the same track. This command turns this ... into this:  
Paste to takes in items	Pastes previously selected and cut or copied takes into selected tracks as a new item.

There are also additional actions, not shown on the menu, that are available in the [Actions List](#).

8.8 Propagating Takes

In Chapter 7 you were shown how to copy a media item's properties and characteristics to all similar media items on the same track or on all tracks. The same principle can be applied to takes, using either of the **Item processing** commands **Propagate take to similarly named active takes on track** or **Propagate take to similarly named active takes** (all tracks). Here is an example.

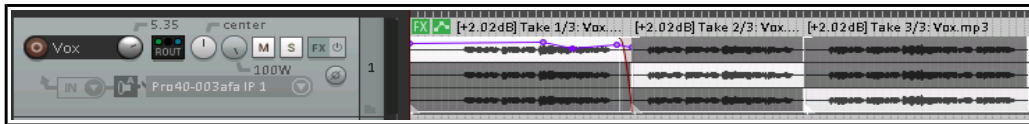

In this example, three takes of a media item have been split into three sections. All takes share the same name (Vox.mp3). FX have been added to the active take for the first section, as have an envelope and a fade out. By choosing **Item processing, Propagate take to similarly named active takes on track** from the context menu, we ensure that these features are copied to the other active takes on this track:

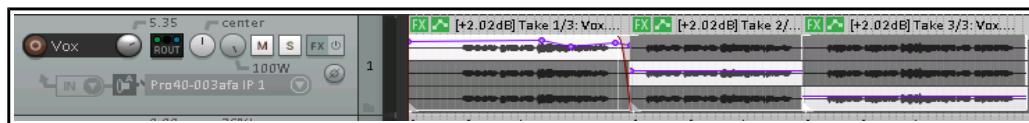



Notice that although the envelope is copied, the envelope points are not.

8.9 More Take Commands and Actions

The Items context menu includes six commands which create a new take from an existing item. The first four of these all involve applying track effects to an existing media item: the first three create a new audio take and the fourth creates a new MIDI take. The table below summarizes these commands.

Command	Explanation
Render items as new take	Renders the existing media item as a new take. Any MIDI items with take FX (such as VSTi) will be rendered as audio.

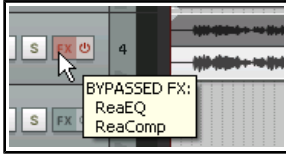
Command	Explanation
Reverse items as new take	<p>Adds a new take to the media item with the content reversed. Here's an example. Starting with this ... we end up with this:</p> 
<p>Apply track/take FX to items as new take - creates a new stereo take for the selected item.</p> <p>Apply track/take FX to items as new take (mono output) – creates a new mono take for the selected item.</p> <p>Apply track/take FX to items as new take (multichannel output) – creates a new take for the selected item, with the same number of channels as are defined in the track's routing window.</p> <p>Apply track/take FX to items as new take (MIDI output) – creates a new MIDI take on selected MIDI item.</p>	<p>One use for these commands is to free up CPU if your system is becoming stressed. Consider an example of a track with some FX in its FX chain, say EQ and a compressor:</p>  <p>After applying track FX (mono output), we have a new take with the FX applied to it. The original FX chain can now be set to bypass:</p>  <p>This reduces CPU overload, and opens up creative options- e.g. you can select Play all takes then use pan and volume envelopes to vary their placement and relative volume throughout the song.</p>

8.10 Managing Comps with the Project Bay

To open and display the Project Bay, use the **View, Project Media/FX Bay** command. Click on the tab labeled **Take Comps** to display the takes and comps management section. Clicking on the **Options** button then displays a menu which includes the option to **Mirror selection in bay and project**. This lets you select any media item or segment by clicking on it either in the project itself or in the list shown in the project bay.

Within the project bay window right click over any listed comp for a context menu. Choices include **Activate comp**, **Rename comp** and **Delete comp (keep takes)**. You can also create a new comp from your current take selection by clicking on the **Actions** button (top right) and choosing **Create new comp** from that menu.

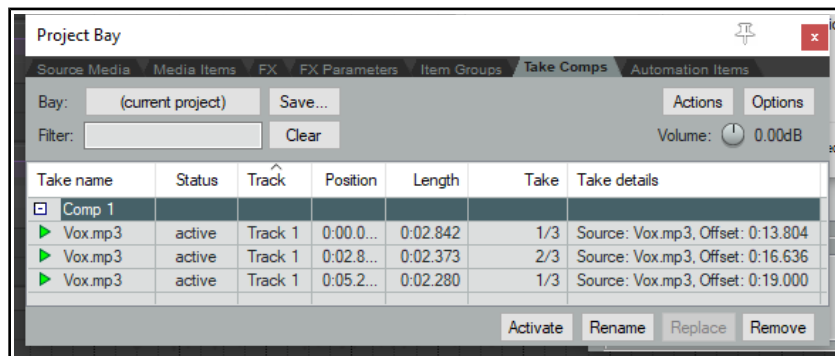

8.11 Item Take Markers

REAPER supports project markers and take markers. **Project markers** are explained in Chapter 9. Take markers are attached not to a point in time on the project timeline but to a specified location within a specific media item. Thus, by using take markers you are easily able to identify and jump to any marked point in any item or take. If the media item is moved, the marker is moved with it. If the item is modified (e.g., by changes to its playback rate or by stretching) then the marker position will be adjusted accordingly. To create a take marker:

- Position the mouse cursor and select the media item or take: the play/edit cursor should automatically jump to the required position. Choose **Take markers, Add/edit take marker at cursor** (from either the main Item menu or the media item right click context menu).
- In the **Edit Take Marker** dialog type a name and either set the color of your choice or accept the default.
- Click on **OK**. The take marker will be displayed on the media item itself (as shown above).

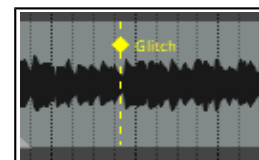

Managing, Comping and Editing Takes

In order to do this you should do this.
Turn on/off snapping to markers	Enable/disable snap to selection/markers/cursor in the snap dialog . Snap on also requires that snap to media items be enabled.
Add a take marker to an item	Follow the instructions above (from first bullet point). If the item has multiple takes, select the required take before doing this.
Add take marker during playback or recording *	Run the action Item: Quick add take marker at play position or edit cursor . Double-click to edit it later if you wish to add a name.
Move a take marker	Position mouse cursor over the diamond shaped mark then left click and drag.
Copy a take marker	Use Ctrl left drag .
Edit a take marker	Double-click on the diamond shaped mark (e.g. to change its name or color).
Delete take marker *	Alt click on marker, <i>or</i> Select take marker, then choose Delete take marker at cursor or Delete take markers in time selection or Delete take markers in item from Take markers menu.
Jump to take marker	Press Ctrl J to open Jump to dialog. Type the letter k followed by an apostrophe and the marker name to jump to a specified take marker. E.g. to go to a take marker called <i>glitch</i> , you would type k'glitch in the jump to box.
Up-rank or Down-rank take markers.	See Comping with Take Markers to see how take markers (including up-ranked and down-ranked take markers) can be used as an aid to comping.
Move play cursor to next/previous item take marker	Use actions in Action list . These can be assigned to keyboard shortcuts if you wish. For other relevant actions search or <i>take marker</i> in the Actions List.

Tip 1: The [Region/Marker Manager](#) (Chapter 9) provides an environment where you are able to manage your take markers – for example to edit or delete them, rename them, reposition them, change color, and so on.

Tip 2: The media item take marker section of your mouse modifiers enables you to customize take marker behavior for left drag, left click and double click.

8.12 Comping with Ranked Take Markers

Ranked take markers can assist you in exploring and evaluating your options when comping, whether you are using legacy takes or [fixed media lanes](#). The example that follows uses legacy takes, but these techniques can also be adapted to apply when working with fixed media lanes. (With fixed media lanes you will need to enable **Allow editing source media while comping** from the right-click **Comping** menu.)

Take markers added to sections of each take can be up-ranked (yellow face) or down-ranked (red face). This can assist you in identifying where to slice and dice your takes and in removing unwanted segments.

Note the section of the Take Markers context menu shown on the right. These commands can be used to add and work with up/down ranked take markers.

You might find it rather clumsy to work with the mouse both to move around the mouse cursor and use right-click context menus at the same time.

For this reason, you should familiarise yourself with some of the keyboard shortcuts that are available perform many of these tasks. Some examples of these are listed below. You might also wish to add some of your own to suit your own workflow.

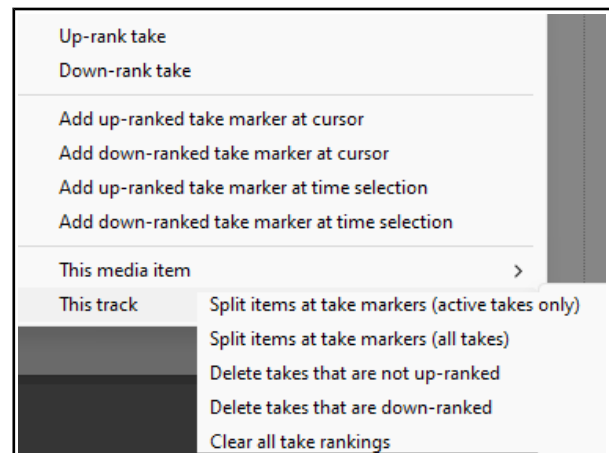

Before we start, make sure that you are familiar with [basic item take marker management techniques](#) as outlined earlier in this chapter. These include snapping to, moving and deleting take markers.

Up and Running: A REAPER User Guide v 7.31

Examples of Default (**) and Suggested (##) Keyboard Shortcuts

Split item at edit or play cursor **	S	Insert marker at current position **	M
Go to next take **	T	Go to previous take	Shift T
Up-rank take marker at play position or edit cursor ##		Num + (see Tip 1 below)	
Down-rank take marker at play position or edit cursor ##		Num - (see Tip 1 below)	
Delete take marker at mouse position ##		K	
Split items(s) at time selection or razor edit		Shift S **	

Tip 1 After assigning Num + and Num - you can still zoom in/out horizontally using the up and down arrows.

Tip 2: Consider keeping the [Region/Marker Manager](#) open as a secondary option when editing take markers.

Example

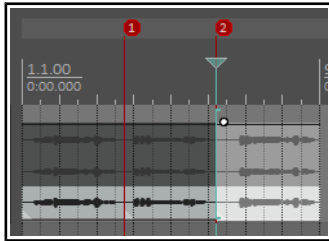

There is no “one size fits all” method of working with take markers. This example outlines one possible approach to help you to understand some possibilities. It shows a simple item with three takes. We can split it into segments then use take markers to evaluate and ultimately select a preferred take in each segment.

1. We can split the item into segments adding a marker at each split. This makes it easier to navigate accurately and quickly between segments. Pressing the marker number key (e.g. 1, 2, or W to return to the beginning) will navigate us to any required marker position.

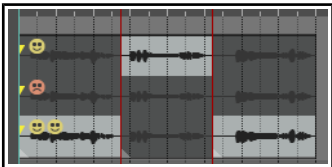

2. We can select the first segment and press **Home** (or **W**) to move the cursor to the start position. Pressing **T** will cycle through the takes for auditioning. Pressing **Num +** will add an up-rank (yellow) marker at the current position. Pressing **Num -** will add a down-rank (red) marker. For any we especially like, repeating **Num +** will add an additional happy face marker, up to five.

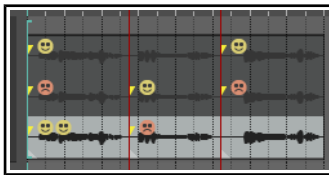

3. We repeat this process for the other segments. At any time we can go back and use **Alt click** to remove unwanted markers or. We can also add up-rank/down-rank take markers anywhere else that we need to, not only at the markers. Eventually we might end up with something similar to that shown here (above right).

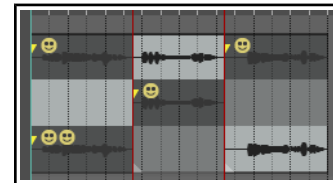

something similar to that shown here (above right).



4. We can select the whole item and use the **Take Markers** context menu command **This track, Delete takes that are down-ranked** to remove those takes that we definitely do not like (as shown left).

After further auditioning we can delete any unwanted up-ranked take markers so as to leave only one marker per segment. Then **Take Markers, This track, Delete takes that are not up-ranked** will leave us with only the best take in each segment (as shown left).

A Different Approach

Another approach is to define the take markers first and split the items afterwards.

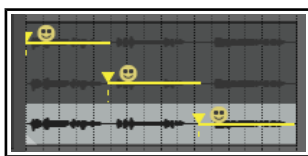

In this case, the three up-ranked markers have each been added individually by making a time selection, selecting the required take and then choosing from the **Take markers** context menu **Add up-ranked marker at time selection**.

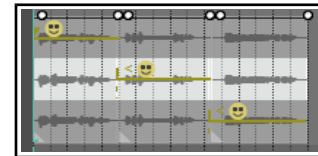

The **Take markers** context menu command **This track, Split items at take markers (all takes)** will now split the item as shown on the right.

Take markers, This track, Delete takes that are not up-ranked can now be applied to this item. Pressing **Ctrl L** will now cause your preferred takes to be displayed in a single lane.

Note: Up/down-ranked take markers added in this way can be lengthened or shortened by picking up the end with your mouse and dragging to the right or left.

Managing, Comping and Editing Takes

8.13 Fixed Media Item Lanes

This section requires an understanding of REAPER's recording techniques, including layered recording (see sections 3.1 to 3.5 and 3.14). Some understanding of REAPER's legacy takes system is also recommended.

Media item lanes offer you a way of working that goes beyond the limitations of REAPER's basic track structure.

By default, media items will fill the entire vertical space of the track on which they are recorded. If the media items overlap, they are auto-arranged vertically based on your media item properties settings. Media items that overlap interact during playback according to the **project settings** (**Project settings, Advanced, Item mix behavior**), preferences settings (**Preferences, Project, Item fade defaults, Preferences, Project, Track/Send Defaults** (shown right), and **Preferences, Appearance, Zoom/Scroll/ Offset**), track settings, and/or **media item properties** for item mix behavior (shown above right). If media item and project settings differ from each other, media item settings will apply.

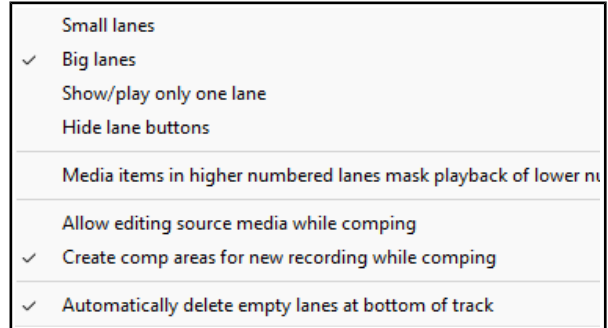

With **free item positioning** you can freely position and resize media items within the vertical space of the track. However, this feature is not designed with project building in mind. Fixed media item lanes offer you various tools and techniques for building projects. They can be used to record, layer, edit, manage and comp material. They are effectively tracks within tracks, up to 256 lanes within a single track. REAPER then gives you multiple options to treat these tracks individually, linked by comping, or in other ways related.

To give you some idea of where we're eventually going here is a relatively simple example::

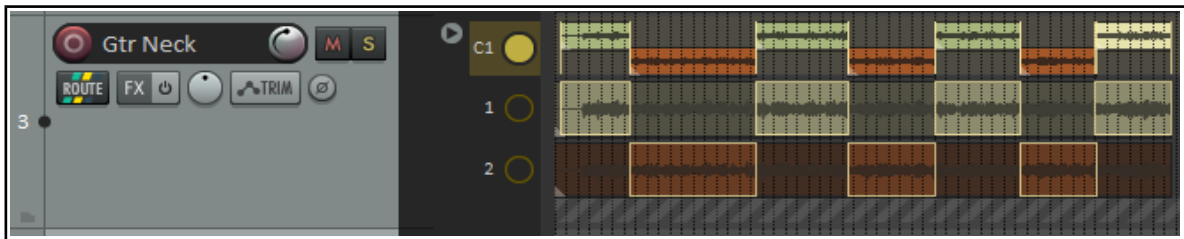

Look at the above illustration. Notice:

- ◆ The track shown comprises three lanes, labeled in a lanes panel (top to bottom) C1, 1 and 2.
- ◆ Lanes 1 and 2 are two takes of the same tune. Lane C1 is a work in progress comp of the best parts of lanes 1 and 2.
- ◆ To the right of the track panel a new section has been added: this shows a labeled button for each lane (in this example, three buttons) as well as housing its own right-click context menu. Those options whose initial defaults are determined by your preferences settings can here be over-ridden for individual projects.

8.13.1 Recording and Layering Media Items -Example

We can begin by working through a relatively straightforward example, to help understand the basics, then go on to consider more powerful and complex models.

1. Make sure that the following conditions are set on your **Options** menu:
 - Record mode normal**
 - Offset overlapping media items vertically**
 - Overlapping recording behavior** then either **Add lanes** or (if you prefer) **Add lanes (layer new lanes)**. This latter option should only be chosen if you wish to play the new material along with any existing lanes.
2. Create a new, empty project file (**Ctrl N**). Add a track and either (using an instrument of your choice) record a tune for about a minute, or import an existing media file.
3. Insert a new track after your recorded track. Expand its height to be similar to that shown above.
4. Now record, one at a time, two takes of a second instrument, to go with your first track, *both on the same track, one over the top of the other*. When finished, disarm the record button.

Up and Running: A REAPER User Guide v 7.31

Your arrange view display should now be something like this (right). There's a lot to see here, including those buttons, so let's make sure we understand what's happened.

Two separate media items have been recorded and are displayed in lanes one above the other. By default, only one item will play back: there are options to change this, for example, to play a selection of lanes, or all lanes. They each exhibit all the properties of any media item, for example:

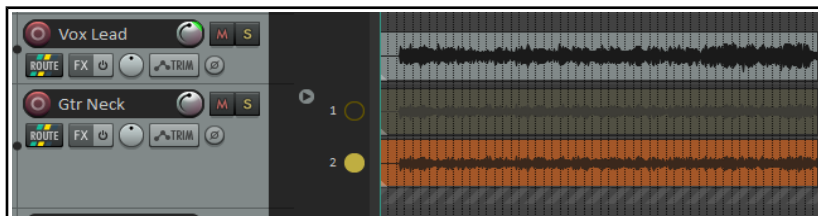

- ◆ You can double click on any item to access and edit its media properties, such as pitch, pan, etc.
- ◆ Keep in mind that Options, Preferences, [Appearance](#), [Media](#) will allow you, for example, to add a volume knob or FX button to items: you can then [add FX](#) and FX parameter envelopes.
- ◆ You can split items and edit individual segments independently of each other.
- ◆ Check out your Fixed Lane Default options at [Preferences](#), [Project](#), [Track/Send Defaults](#)). These include small or big lanes, whether to show/play only one lane, hide lane buttons, for media items in higher numbered lanes to mask playback of lower numbered lanes, to allow editing source media while comping, to create comp areas for new recording while comping.

8.13.2 Managing and Editing Items

Right click over (or just below) either of the buttons to display a context menu. Note that this includes a set of three playback commands – **Play only (selected) lane**, **Toggle playing lane** and **Play all lanes**. Where there are multiple lanes, you can select any number of lanes to be played back by **Ctrl click** on the lane names.

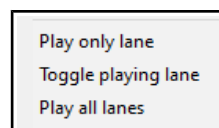

When layering, the tricks and techniques described below are at your disposal.

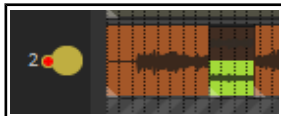
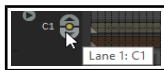
Menu option/Mouse option	Comments
Select playback lane(s) from menu	Click on a lane's button/ Right click in lanes panel, select Play only lane , Toggle playing lane or Play all lanes from menu.
Select lanes to play	Click on first lane's button then use Ctrl click to build selection.
Select items	Selects all media items in currently selected lane.
Duplicate items to new lane	Copies all media items in currently selected lane into a new lane. Use this, for example, if you have "dry" recorded material and you want to experiment with editing and/or using FX,
Recording, Record into lane Recording, Record into first available lane Recording, Layer new lanes	Select lane for recording and choose Recording, Record into lane from menu. A red dot will be displayed. Can be used, for example, for overdub recording, as shown here. You can also enable Play only this lane . If Record into first available lane is disabled, a new lane will be created for every recording. If Layer new lanes is enabled new lanes will play alongside any lanes already playing: otherwise only the new lane will be played. 
Toggle a track's fixed item lane status on/off	Right click over the track's control panel and use the toggle command Fixed item lanes on the context menu.
Change selected lane when height is in collapsed state	Click on Up/Down arrows on the single displayed track button. 
Add empty lane at bottom	Adds lane as last lane in track. Media items can be dragged from elsewhere and dropped inside this lane.
Delete, Automatically delete empty lanes at bottom of track	Will remove any unwanted empty lanes at bottom of track.

Managing, Comping and Editing Takes

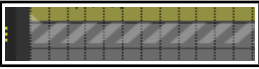
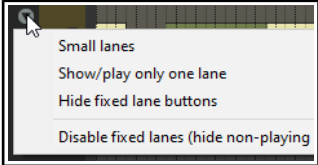
Menu option/Mouse option	Comments
Insert new empty lane above this lane	Inserts an empty lane as specified. Use drag and drop to insert previously recorded media items into this lane. This could be a reference track to be played with new recorded items. You can use Record into an existing lane to record into it.
Insert a media item into a new lane.	Drag and drop item into the striped parking area located below the last lane. 
Rename lane	By default lanes are named in sequence – 1,2, 3 etc. To rename any lane, double-click on the lane name, type the name and click OK .
Media item playback option	Option for Media items in higher numbered lanes to mask playback of lower lanes .
Delete lanes (with submenu).	Options to Delete lanes (inc media items) , Delete all other lanes , Delete all lanes with no media items , Delete lanes (inc media) that are not playing , Delete lanes (inc media) with no comp areas and Delete all lanes (inc media items) .
Item colors (with submenu)	Set all items that share the same media source to the same random color or Set items in all lanes to one color per lane .
Manage lane display options Disable/enable fixed lanes	Right-click on lane collapse button for toggle options for Big/small lanes , to Show/play only one lane (Shift click), to Hide fixed lane buttons (Alt click) and to Disable fixed lanes (hide non-playing lanes) . 

8.13.3 Comping with Media Item Lanes

Using your mouse you can quickly and easily build a comp (or comps) from your media item lanes. One important difference between this and REAPER's legacy comping system is that *the material is comped into new items*. Your original items are not modified in any way.

To turn comping on in a new lane, from the lane panel's context menu choose **Comping, Comp into new empty lane**. A new lane will be inserted above the existing lanes. Shown here, it is labeled **C1** – **Rename lane** from the context menu lets you change this.

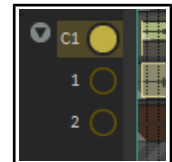

To toggle comping on/off in an existing lane, double-click on the required lane button.

It's a good practice to finish any edits on your source media items before you begin comping. **Comping, Allow editing source media while comping** can be toggled on/off from the context menu. Even with this option turned off you will still be able to perform edits on the contents of comped lanes.

Use left drag to define areas to be comped. Shown here an area has been selected from each of the two media lanes. They do not meet up. To fix this, simply drag the border on either of the two areas towards the other, as shown below left. You can then if you wish drag this border either left or right to adjust the relative comp areas, as shown below right.

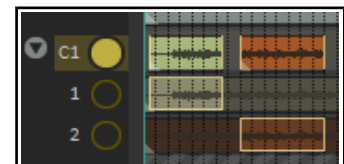

The vertical yellow marker lines in comp lanes can be used to adjust the borders between segments. Note that comping actions copy the comped segments as new media items. The items in comp lanes can be edited (e.g. by adding FX or fades) without affecting the original media in the source

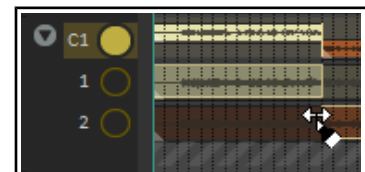

lanes in any way. Below is a summary table of various comping tasks, commands and actions.

Tip: Working with comp lanes can involve a lot of mouse movements, and especially dragging. It can be quite tricky at first, and you might find that you slip up from time to time! A handy tip is to keep your **Undo History** window open so that if you do get into strife you can easily go back to your last known safe spot.

Context menu command	Items in Comp Lane - Comments
Split comp area here	Splits comp area at current cursor position.
Delete comp area	Deletes comp area under mouse cursor and removes media from comp.
Delete comp area but not media items	Removes comp area but leaves media item in place.
Delete comp area edge	Removes edge line between two comp areas in same lane.
Add comp area at time selection	Adds a comp area matching current time selection.
Track panel context menu	Comments
Fixed item lanes	Toggles fixed item lanes status on/off.
Panel context menu	Comments (see also Managing Comp Lanes , below)
Comping, Delete comp area inc source media	Removes all comp areas from selected lane along with the actual media.
Comping, Turn off comping	Turns comping off. To turn it back on, use one of the Comp into ... commands explained below.
REAPER Options menu	Comments
Offset overlapping items vertically	Can be toggled off if you wish to show cross-faded comped material overlapping.
Snap/grid, Snap/grid settings	Toggle options to Snap media items to media items in other fixed lanes and Snap fixed lane comp area to media items .

8.13.4 Managing Multiple Comp Lanes

To add additional comp lanes, from the context menu choose **Comp into a new empty lane**. You can drag and drop this new lane up or down the lane order.

To make a copy of a currently active comp lane for further editing either use the context menu command **Comping, Comp into a new empty lane, automatically creating comp area**. Note that this command prioritises higher numbered lanes over lower numbered lanes.

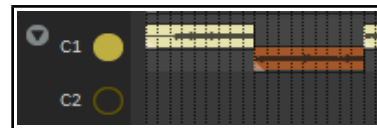

These commands, as well as **Comping, Comp into new copy of this lane** and **Comping, Comp into this lane**, are also available on the track panel's right click context menu.

When you have multiple comping lanes to change which one is active **Shift Ctrl click** over the lane button.

To make an empty media lane into a comp lane, **Double click** on its panel button.

There is also a menu option **Comping, Refresh comp areas with no matching media in comping lanes**.

When working with multiple lanes which include material you might need to prioritise lanes. The context menu toggle option **Media items in higher numbered lanes mask playback of lower lanes** can be useful here. This can be turned on by default in your **Project, Track/Send Defaults** preferences settings.

See **Mouse Modifiers for Power Users** for a full list of relevant mouse modifiers.

Mouse Gestures in Comp Lanes and Media Lanes

By default you can edit media items in comp lanes in the same way as other media items. To make this possible without interfering with your comping, you will see that comp lanes are horizontally divided into two areas.

When the comp lane is selected the larger upper area behaves like any normal track. You can make time selections, edit media items and so on by using your mouse in this area. The smaller lower area can be used for comping – for example, to drag and move comp borders.

You can make a time selection in the upper area, then right click in the lower area within that selection and **Add comp area at time selection**. This inserts two yellow marker lines and creates an area that you can fill later.

This will not apply to your media lanes if you have **Allow editing source media while comping** disabled.

Managing, Comping and Editing Takes

8.13.5 Editing Media Items

Ideally you'll want to finish media item edits before comping. However, you might need to make edits to one or more of your items after you have begun comping.

In this case, you can enable editing using the context menu toggle command **Comping, Allow editing of source media while comping**. The display changes, as shown on the right. The top half of each source lane is where you make your edits. The bottom half highlights your comped segments, as shown here (right).

Your editing can include fades and/or crossfades. Any fades/crossfades applied to media in the source media lanes will also be applied in the comp lane. However, the fades in the comp lane can be edited independently if you wish, as shown here (below right). Double-click in the crossfade area if you want to access the crossfade editor.

It is possible that in making your edits your source item could now get out of sync with your your comp lane. Happily, the area of the source lane that was originally copied to the comping lane will remain highlighted: clicking there is one way to restore the original comp area and remove whatever edits were made in that lane.

Another option is to use re-comping: choose **Comping, Copy edited media items to new lane and re-comp** (Shift left click) from the comp area context menu. This will preserve comp lane edits by moving them to a new source lane and creating a new comp area so that the edits are copied right back to the comp lane. Thus, the edits become a new source lane alternative which is available for you to use while comping.

Other options are **Copy all edited media items to new lane and re-comp**, **Copy edited media items back to source lane and re-comp** and for unsynced media items **Discard media item edits and re-comp from source lane**.

When you have finished editing, remember to disable **Allow editing of source media while comping**.

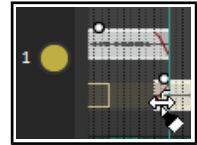
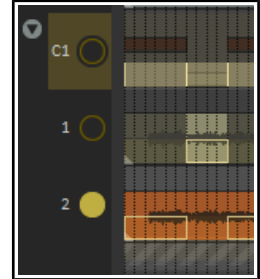

8.13.6 Sealing the Deal

So ... you've finished editing and comping your media items, what now? You might wish to protect your comps from any accidental damage. You have a number of options. For example, two possibilities are:

- ◆ Right-click on the comp lane's control button and choose **Show only lane** from the context menu. This will collapse the track as shown here. Marquee all items in the comp lane, press **F2** to open the **Media Item Properties window**. Select **Lock** then **OK**. From the track panel context menu disable **Fixed Item Lanes** for this track. ...or...
- ◆ Marquee all items in the comp lane then **Ctrl drag and drop** to copy to a new track. With all items still selected, press **F2** to open the **Media Item Properties window**. Select **Lock** then **OK**. Use the **Track Manager** to mute and hide your original track.



8.13.7 Converting Takes to Lanes

Existing tracks that using REAPER's legacy takes system can be converted to fixed item lanes. Select the track, from the right click menu choose either **Fixed item lanes** or **Fixed item lanes (convert takes to lanes)**.

Thus this ...

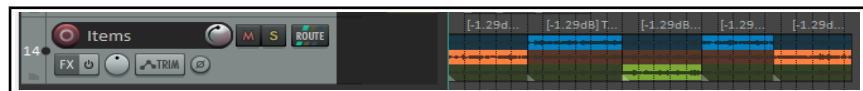

Becomes this ...

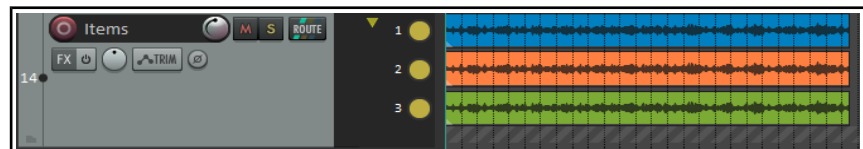

Then, after turning on **Comping, Comp into new empty lane**.

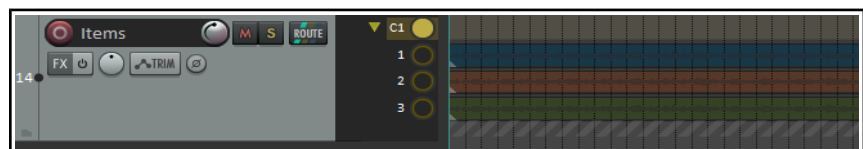

8.13.8 Preferences and Options

REAPER's **Appearance, Track Control Panel** preferences include an option to specify default behavior for the fixed lane collapse button, to toggle between showing one or many lanes, and displaying lanes as big or small.

Project, Track/Send Defaults includes an option to make fixed item lanes the default for new tracks. Other default options include small or big lanes, show/play only one lane, hide lane buttons, allow editing of source media while comping, record into first available lane, create comp areas for new recording while comping.

Assignable Actions for Power Users

The actions list includes numerous fixed lane comp area actions which can be assigned to keyboard shortcuts, or toolbar buttons, or as mouse modifiers. For more details of options, see the Actions List (**Actions, Show actions list**).

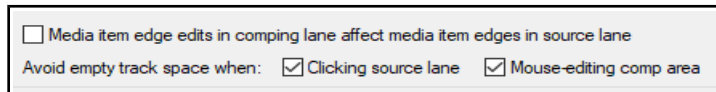

- Add comp area for lane under mouse**
- Move comp area up/down**
- Set loop points**
(inc with half or one second preroll/postroll)
- Split comp area**
- Split media items**
- Move comp area**
- Razor edit: create comp area**
- Copy comp lane items**
- Delete comp areas**

- Move items down to next available lane**
- Delete lanes**
- Turn comping on/off**
- Explode takes on selected tracks to fixed lanes**
- Set various options for all fixed lane tracks**
- Make all lanes big or small**
- Show only one lane or all lanes.**
- New recording adds lanes**
- New recording adds lanes in layers**
- New recording does not add lanes**

Mouse Modifiers for Power Users

Fixed lane comp area – Left drag

Default action	Move comp area.	Alt	Move comp area and media items.
Shift	Move comp area ignoring snap.	Shift Alt	Move comp area & media items, no snap.
Ctrl	Copy both comp area & media item.	Shift Ctrl Alt	Move comp area and a
Shift Ctrl	Dito, together ignoring snap.		

Fixed lane comp area – Left click

Default action	Move comp area to lane under mouse.	Shift Alt	Heal comp area with previous adjacent comp area in same lane.
Shift	Comping, Copy edited media items to new lane and re-comp	Ctrl Alt	Delete comp area but not media item.
Alt	Delete comp area including media item.	Shift Ctrl Alt	Extend comp area to next comp area or end of media.

Fixed lane comp area – Double click

Shift	Set loop points to comp area.
Ctrl	Extend comp area to next comp area or end of media.

Fixed lane header button – Left click

Default	Play only this lane.
Ctrl	Toggle playing this lane.
Alt	Play only this lane while mouse button is pressed.

Fixed lane header button – Double click

Default action	Comp into lane.	Shift Ctrl	Insert lane.
Shift	Select items in lane.	Alt	Delete lane (including media items).
Ctrl	Toggle playing this lane.		

Fixed lane comping preferences:

The **Editing behavior, Fixed lane comping** section of preferences includes options to manage some of the potentially trickier parts of aspects of fixed lane comping behavior. Further explanations and help messages are included on that page.

Loops, Project Markers and Regions

9 Loops, Project Markers and Regions

Note: Many of the arrange view illustrations used in this chapter use earlier REAPER default themes and color schemes. The information and instructions, however, are still accurate and correct for REAPER 7.

9.1 Creating Loops

Any audio, MIDI or click source Item can be looped. Indeed, by default REAPER media items are loop enabled. You can disable this for individual items in the Media Item Properties dialog box, or globally (for MIDI and imported items) on the [Project, Item Loop Defaults](#) page of your Preferences.



The loop point is defined by the duration of the source media. If you insert an item that is four bars long, it will loop every 4 bars, if it is 8 bars, it will loop every 8 bars, etc. Note that in the following examples, if you are using beats for your timebase, the item must be an exact number of beats in length, or it will not loop in sync. If necessary, adjust the playback rate (Media Properties) while preserving pitch, then glue the item to do this.

To Loop an entire Item:

1. Hover the mouse over the edge of an Item until the Cursor changes to a double-headed arrow (see right).
2. Drag the Cursor to extend the Item. Each loop point will be indicated by a notch in the item edges.
3. The length, start time and end time of the looped item will be displayed as you drag the edge of the loop.



Cropping and Looping:

If you wish to loop only part of an item, then one method is to first crop and glue the item.

1. Make sure snapping is enabled. Hover the mouse over the edge of the Item until the Cursor changes to a double-headed arrow. Click and drag the mouse in on the item to make it shorter, so that you are left with only that part of the item that you want to use as the basis of the loop. Release the mouse button.
2. Right click over the item and choose **Glue items**.
3. Now drag the Cursor to extend the Item. Each loop point will again be indicated by a notch in the edges of the item. Extend the loop as required.



Changing Playback Rate:

There may be times when you will wish to change an item's playback rate, for example to keep it in sync. Taking the same example as above, you would first display the [Item Properties](#) box, and most probably make sure that **Preserve pitch when changing rate** was selected. You could then change the **Playback rate** (for example, to 2.0). This would have the effect shown here. The original item (looped) as shown above has had its playback rate modified (right).



Up and Running: A REAPER User Guide v 7.31

Creating a Loop from a Time Selection

Another way of creating a loop from only part of an item is to select the required item, highlight the required part of it as a time selection, right click, choose **Copy loop of selected area of items**, remove the original, then paste in the loop in its place. This is shown here:

1. Select first the source item, then select the area to be looped (see above). Either press **Ctrl Alt L** or right click and choose **Copy loop of selected area of item**.
2. Select the track and position to which you want the item copied.
3. Press **Ctrl V** to paste in the area to be looped.
4. Drag the cursor from the edge of the item as before to create the loop.

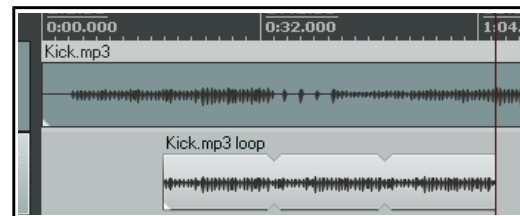

9.2 Creating and Navigating with Project Markers

Project Markers are like bookmarks. They can help you when you are navigating, arranging and editing your projects. T can be inserted at the current Edit Cursor position, whether or not the project is being played.

Action	Shortcut	Effect
Insert, Marker command	M	Inserts numbered Marker at present position.
Insert, Marker (prompt for name) command	Shift M	Inserts numbered Marker at present position and opens dialog which prompts for a marker name. Other options include Set color... to color the marker.
Right click mouse over marker		Displays menu to Edit Marker or Remove Marker.

Keyboard and Mouse Shortcuts

Default Keyboard and Mouse Shortcuts for creating and navigating with markers are:

To do this ...	Mouse/Keystroke
Go to marker 1 thru 10.	1 thru 0 on main keyboard, not Num Pad.
Move marker 1 thru 10 to cursor position, or create new marker if no marker of that number exists.	Ctrl 1 thru Ctrl 9 and Ctrl 0
Go to next marker/ project end or previous marker/ project start.] or [
To jump to any marker.	Ctrl J opens Jump To dialog. Type m and marker name or number – e.g. m2 to jump to marker 2.
Jump to marker using the Transport Bar.	Right click on Transport Bar then Jump to marker
Open Edit marker dialog (e.g. to add or change marker name or change marker color).	Shift double-click on marker number. Type a new name, or click on Set color .
Make loop selection in REAPER's main arrange view or in the MIDI Editor piano roll view.	Double-click on ruler between two markers
Select area between the two markers.	Double click on timeline between markers
Move a marker.	Click and drag marker along timeline
Remove a marker.	Alt Click on marker

Example

This example illustrates the use of markers. Before you begin, on the **Options** menu, enable the option **Loop points linked to time selection**.

Loops, Project Markers and Regions

1. Open the sample file **All Through The Night.RPP** and immediately save it as **All Through The Night MARKERS.RPP**
2. Play the song, pausing playback immediately before where the vocal starts. Press **Shift M**. When prompted, type as the name **Verse 1 Start** and press **Enter**
3. At the end of the first verse, press **Shift M** again, name this marker **Verse 1 End** and press **Enter**.
4. Create similar markers for the start and finish of Verse 2 and Verse 3. If you are displaying the ruler in minutes and seconds these will be at or around 0:57, 1:35, 1:43 and 2:31. Save the file.
5. Press **1** on your keyboard (not the numeric keypad). Notice the edit cursor jumps to the start of Verse 1.
6. Press **2**. Notice it jumps to the end of Verse 2.
7. Double click on the timeline ruler (not the markers row) between markers 2 and 3. Notice that this area is now looped and will play repeatedly.
8. Right click over the timeline and choose **Zoom selection**. You could now do any close editing work required for this selection.
9. Press **Esc** to clear the selection, then **Ctrl PgDn** to restore the whole project to view. Save the file.

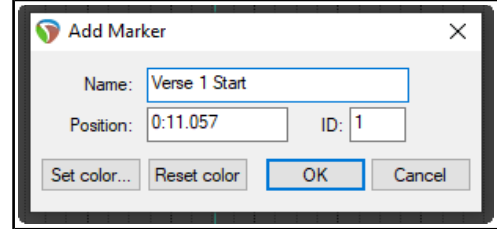

Note: Do not use the names **=START** or **=END** when naming ordinary markers. These names should be used only when creating special markers which can be used to denote the start and end of a project. This information will be used by REAPER when rendering an entire project to audio media (see also [Chapter 21](#)).

9.3 Time Selection Start/End Markers

REAPER treats the start and end of any current time selection as floating markers. The shortcut keys for **Go to next marker** and **Go to previous marker** are **]** and **[**. These will also find the start or end of the current time selection and move the play cursor there.

You can also right-click over the **Go to start** button and enable the option **Use transport home/end for markers**. The Go to start and Go to end buttons will now find the previous/next marker or start/end of a time selection when one is current.

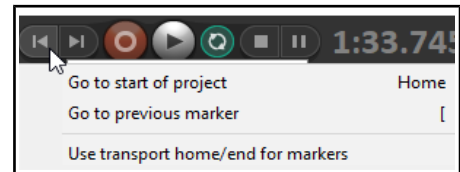

9.4 Snapping to Markers

You might wish to ensure that when you are making a time selection, the boundaries of the selection will automatically snap to nearby markers at the start and/or end of the time selection (if any such markers are present).

Consider the portion of the [Snap/Grid Settings](#) shown on the right. Notice that snapping has been enabled, with a snap distance of 10 pixels defined.

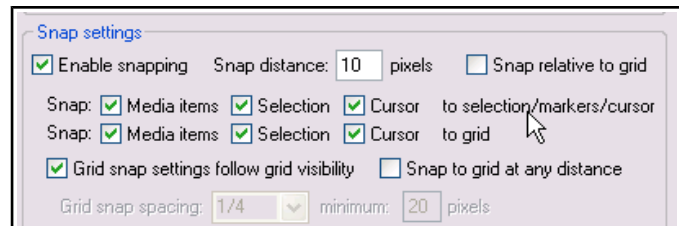

With snapping *disabled*, it can be quite difficult to make a selection which starts or ends exactly at a marker. When you attempt to make such a selection, you might end up with the selection shown in the first of the screen shots below. Notice that the end of the selection doesn't quite match the marker.



However, in the second example shown, with snapping *enabled* and the settings shown above, if you drag the selection to within 10 pixels of the marker position, the selection will automatically snap to the marker when you release the mouse. Notice the effect of making exactly the same selection with the above snap settings disabled (left) and enabled (right).

Example

Up and Running: A REAPER User Guide v 7.31

In the first screen shot (below), a project contains two markers, at the start and at the end of the project.

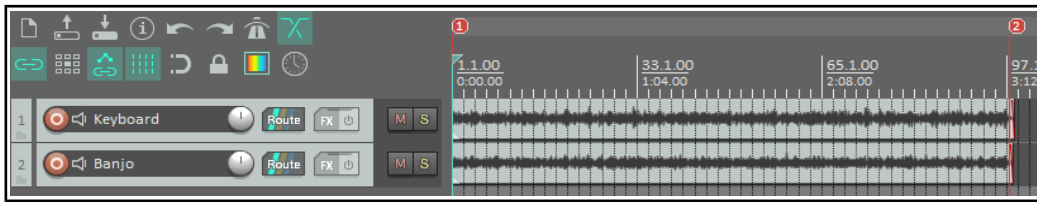

Suppose that you wish to reposition Marker 2. Simply position the edit cursor there and then press **Ctrl 2**.



Now let us suppose that you want to create Marker 4 at the end of the song, reserving Marker 3 for a position as yet unspecified. You can position the edit cursor at the end of the song and press **Ctrl 4**.



9.5 Removing Markers

There are two main methods of removing unwanted markers.

To remove a single marker

Position the mouse over the marker "flag" and hold down the **Alt** key while you click the left button. Alternatively, right-click over the marker flag and choose **Remove Marker** from the context menu.

To remove a series of markers

Define a time selection that includes all of the markers that you wish to remove. Right click over the space just above the marker "flags" within the time selection, and choose **Remove all markers from time selection** from the context menu.

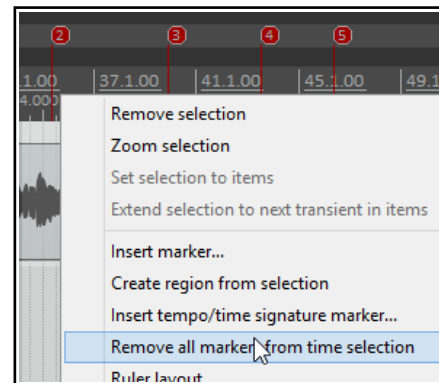

9.6 Show/Hide Regions/Markers in Grid

You can choose whether or not to show project region/marker lines and/or time signature changes on the grid by enabling or disabling the relevant preferences. These can be found on the [Options, Preferences, Appearance](#) settings page.

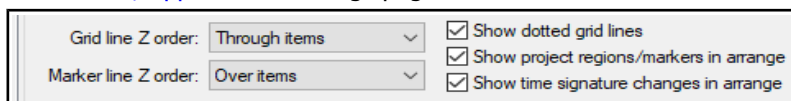

9.7 Marker Actions

The [Actions List Editor](#) includes actions to help manage markers. These include **Markers: Delete marker near cursor** and **Markers: Renumber all markers in timeline order**. Chapter 15 explains in detail more about actions and about how you can assign them to toolbars or to your own shortcut keys.

Loops, Project Markers and Regions

9.8 Creating and Using Regions

Regions essentially take the idea of markers one step further. You can create regions for your projects, making it easy to identify, select and work with different passages of a song.

To do this ...	Mouse/Keystrokes/Command
Create a new region from time selection.	Shift R or right click, Create Region from Selection
Create a region from two existing markers.	Enable Loop points linked to time selection . Double-click on timeline below the markers. Right-click, choose Create region from selection from menu.
To change name or other properties of the region.	Shift Double click on region icon.
To specify a color for a region.	Shift Double click on region icon then Set color .
Make the area of the region the current selection.	Double click on region icon.
Adjust region start/finish point.	Left drag on region edge.
To copy a region and its contents.	Ctrl left drag with mouse.
To copy a region without copying its contents.	Ctrl Alt left drag with mouse.
To move a region with its contents.	Left drag with mouse.
To move a region without moving its contents.	Alt left drag with mouse.
Remove a region.	Alt Click on region icon.
Render an individual region.	Right-click over region name, from context menu choose Render region ...

Example of working with Regions

1. Make sure that the **Option** for **Loop points linked to time selection** is enabled.
2. In the file **All Through The Night MARKERS.RPP**, double click on the timeline between the first two markers to select the area.
3. Right click over the timeline, between the markers, and choose **Create Region from Selection**.
4. Hold **Shift** while you double-click on the new region's icon to display the **Edit Region** dialog. Type **Verse 1** and press **Enter**.
5. Double click on the timeline between markers three and four to select this area. Press **Shift R** to define a region. Right click over the icon for this region, choose **Edit Region**, type **Verse 2** and press **Enter**.
6. Repeat this process using the area between markers five and six to create a Verse 3 region. Keep this region selected.
7. Press **Ctrl** with the **+** on the Numeric Pad to zoom in on that region.
8. Press **Ctrl PgDn** to restore the whole project to the screen.
9. Press **Esc** to remove the current selection. Save this file.

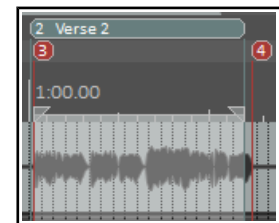
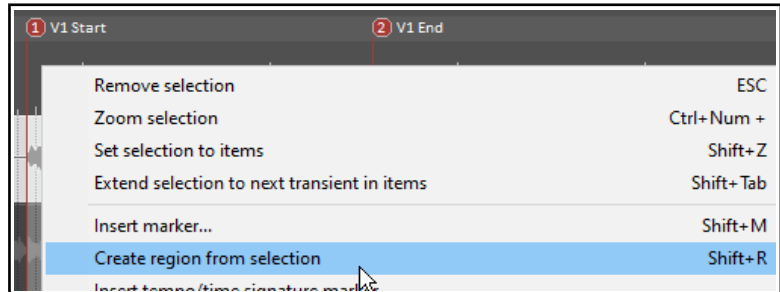

Several actions are available (in the Actions List editor) to help you create and manage regions. These include **Markers: Insert region from time selection** and **Markers: Insert region from selected items** as well as **Regions: Go to next region after next region finishes playing**.

Also, **Project region left drag** and **Project marker/region edge** actions can be customised/edited via your **Preferences, Mouse modifiers** page. Chapter 15 explains in detail more about [actions](#) and how to assign them to [toolbars](#) or to your own [shortcut keys](#), and about [mouse modifiers](#).

9.9 The Region/Marker Manager

The **View, Region/Marker Manager** command toggles this display, used to manage regions and markers (including [take markers](#)).

This manager organises markers and regions using its buttons, its controls and its context menu (displayed by right-clicking on its title bar or in its background area.) This includes options that can later be used within the [Region Render Matrix](#) for rendering.

For additional options for the display of region names and numbers on the ruler, see [Ruler Layout Options](#).

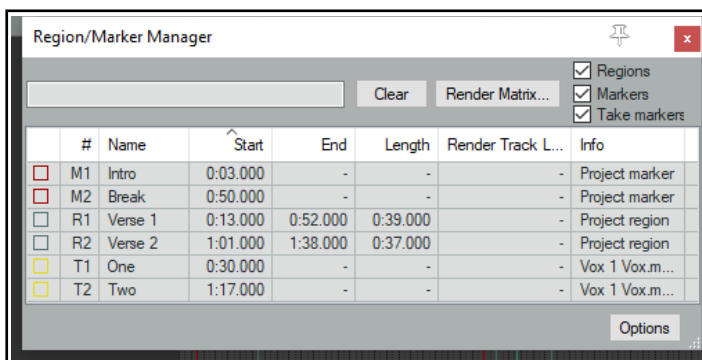

To do this you do this
Select which region/marker types to display	Use check boxes in top right corner of R/M Manager window.
Choose which columns to show/hide	Right click on any column header, select from list.
Sort rows by any column header	Click on column header, twice to reverse sort order.
Change column order	Drag header(s) left or right.
Edit marker/region name	Double click on name.
Zoom to region in arrange view	Double click region number.
Display take markers outside visible media item	Select command from Region/Marker Manager context (right click) menu. By default these are not displayed.
Go to marker in arrange view	Double-click marker number.
Select several markers/regions	Click on first name, then Ctrl click on others to build selection.
Delete markers/regions (but not the media items within them)	Make selection, press Delete .
Change region/marker color	Click in box in first column, then Set color or Random Color .
Change marker name	Double click on marker name, enter new name.
Change marker/region start/end time or length	Double click on current value, enter new value.
Filter marker region list using filter box above the table. See also Boolean Search Filters	Type text string– e.g. <i>verse</i> to list only markers/regions containing that text string. Supports boolean search, e.g. <i>lead</i> OR <i>break</i> finds names including either of those strings.
Find marker/region in manager from the ruler	Right-click on marker/region name on ruler, choose Select in Region/Marker Manager .
Specify tracks to be included when region is rendered	Build selection of tracks in arrange view, then select region, click in Render Track List cell, and choose Render only selected tracks , or click in the region's Render Track List cell and select tracks from menu list, or All Tracks .
Add tracks to region render list	Select from the region's Render Track List dropdown.
Renumber markers, regions in timeline order	Select command from the Region/Marker Manager context (right click) menu.
List markers and regions separately	Enable this option from the manager's drop down menu.
Import regions/markers from .CSV or .TXT file	Choose either to merge or import from context menu.
Add/remove child tracks to render list with parent	Enable this option in the context menu.

Loops, Project Markers and Regions

To do this you do this
Export regions/markers to file	Choose this command from context menu.
Dock R/M Manager in the docker	Choose this command from the context menu.
Seek playback when selecting marker or region	Enable this option in context menu.
Automatically play region thru then repeat or stop when selecting region	Enable this option in context menu.

9.10 Overlapping Regions

REAPER allows for overlapping regions. Create your regions in the normal way. Use the **Ruler** context menu to choose **Ruler layout**, then **Display project regions in lanes** and/or **Display markers in lanes** (toggle). To then display these correctly, you can click and drag down on the boundary between the toolbar and the track panel to create enough room to display all lanes, as shown here.

Also, REAPER's **Action List** includes actions to set ruler height to maximum, minimum or default, and **Mouse Modifiers** preferences allow you to customise **Project Marker/ Region lanes left drag** behavior. For more information about ruler layout options, see the section **Ruler Display Options**.

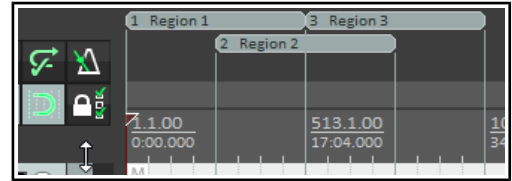

9.11 Project Building with Regions

Regions can be used as a very powerful project building tool, especially when you are constructing a project from samples and/or loops. Two especially powerful features of regions are:

- Drag and drop a region along the timeline to move a region's entire contents.
- Hold **Ctrl** while dragging and dropping to copy a region and its contents, or **Ctrl Alt** to copy the region only, without its contents..



To illustrate this, take a look at the image above. We have started building a project, with an introduction, then a verse (which has been made into a region), a chorus (also a region) and a second verse. By holding the **Ctrl** key while clicking and dragging the icon for the Chorus region to the right, to the end of verse 2, we are able to copy the entire chorus to that point (see below).



Notice that any markers and time signature markers that are inside the region will also be copied or moved when the region is copied or moved.

Note: You can select a series of media items and create separate regions for each item in the selection. Make your selection, then run the action **Markers: Insert separate regions for each selected item**. This action can be [assigned to a keyboard shortcut](#), and/or added to a toolbar, and/or added to a menu – see Chapter 15.

9.12 Markers and Media Cues

If you need to share your media files with other applications that use media cues (for example, Sound Forge) you can convert your markers to media cues when rendering. [File rendering](#) is covered in detail in Chapter 21. REAPER also has an option on the View menu (enabled by default) to show media cues where they exist on imported media items. Moreover, you can use the **Item Processing** command to create markers within REAPER for these media cues.

Example

1. In the screen shot shown below, our project includes a number of markers:



2. We can now select the appropriate tracks and render the file (using the **File, Render**) command, selecting the source option **Stems (selected tracks)** from the Render drop down list, **Mono** channels, and specifying which combination (if any) of markers and regions we want written into the output files as cues. In this example, **Markers only** has been selected.

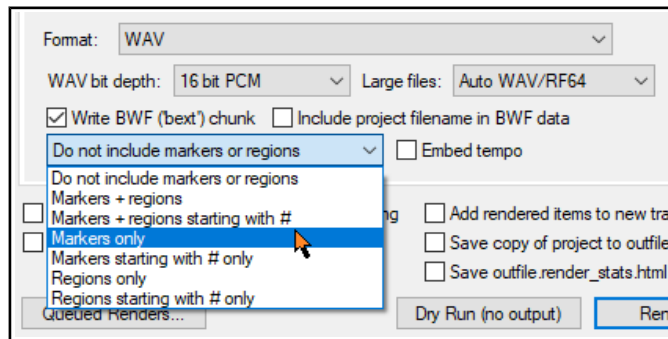

3. If these rendered files were later imported back into REAPER, we can see that the media items contains cues which correspond exactly with the original markers. This is illustrated below. Notice the series of vertical broken lines which indicate the positions of the media cues.

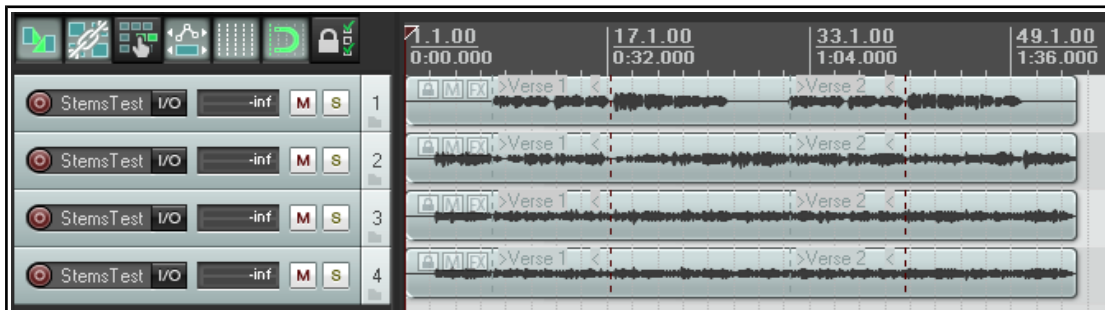

4. If we now select any of these media items then right click and choose **Item processing** then **Import media cues from items as project markers** then a set of REAPER markers and regions is automatically created for the project.

9.13 Changing the Project Timebase

You can select Time, Beats (position, length, rate) or Beats (position only) as the timebase for your envelopes, events and markers. This is covered [later in this chapter](#), but in short:

1. Press **Alt Enter** to display the [Project Settings](#) window. Click on the **Project Settings** tab.
2. Make a choice from the **Timebase for items/envelopes/markers** drop down list, then click on **OK**.

You can also change the beat by clicking in the **BPM** box (on the Transport Bar) and entering a number.

Loops, Project Markers and Regions

9.14 Tempo Based Music Production

REAPER incorporates a number of features which make it a good choice for tempo based music production. Some of these elements (such as creating loops and various item properties) have already been mentioned in the context of other uses. Others have not yet been mentioned. In this section we will draw these elements together to give you a flavour of how REAPER can be used for the production of tempo based music. Creating tempo based music is a process that largely consists of creating and sequencing loops from audio samples. These become the building blocks from which a work is created. Individually they can vary in length from a single note to a complete rhythmical pattern, and anything in between.

One advantage that sampling has over MIDI is sound quality. There are any number of human performance techniques and subtle variations that it is very difficult if not impossible to simulate with MIDI. However, until recently MIDI held one big advantage over sampling. A MIDI track can easily be transposed without altering its tempo, and its tempo can be changed without affecting its pitch. This has not always been the case with audio. Take the example of drum loops. One of the biggest problems with using samplers to trigger drum loops has been that when the tempo changes, so does the pitch. Samplers change pitch by slowing things down or speeding things up. This means that as you play keys up and down your keyboard, you must at the same time handle the issue of beat changes. It becomes almost impossible to get the exact tempo you want without having to open the sampler and make adjustments to the loops.

Today, however, there are available many tools that can do all this for you. The time and pitch altering tools that come with REAPER use high quality algorithms which give you all the options you need to change or maintain such factors as length and intonation. It thus becomes possible to modify samples accurately and without distorting their essential characteristics.

ReCycle is one program that has become popular because its REX grooves automatically arrange themselves to the project tempo on import. Bring in a groove and it always fits the song. Take a set of items representing slices in a rhythmic groove, set their timebase to beats, and change the tempo -- magic! They move all over the place but remain exactly in rhythmic time according to the tempo. Using REX files you are able to play back loops at different tempos without altering the pitch. You're on your way to being able to create drum loops and other sounds exactly the way you want them, and with relatively little effort.

Later in this chapter we'll have more to say about ReCycle, and indeed about REAPER's own dynamic splitting capabilities which puts this magic at your disposal. After dynamic splitting, just double click in the BPM area of the transport bar, enter a number and, hey presto! The whole track plays faster, or slower, in perfect pitch. What's more, the whole track will speed up or slow down naturally, without glitches, pauses or stuttering.

9.14.1 Project Settings

Before creating any music, you should make sure that your project settings are specified correctly. To display the [project settings dialog box](#), press **Alt Enter** or choose the command **File, Project Settings...** from the main menu. In particular, check the following:

- Under **Project Settings**, Set project BPM.
- Under **Project Settings**, Set time signature.

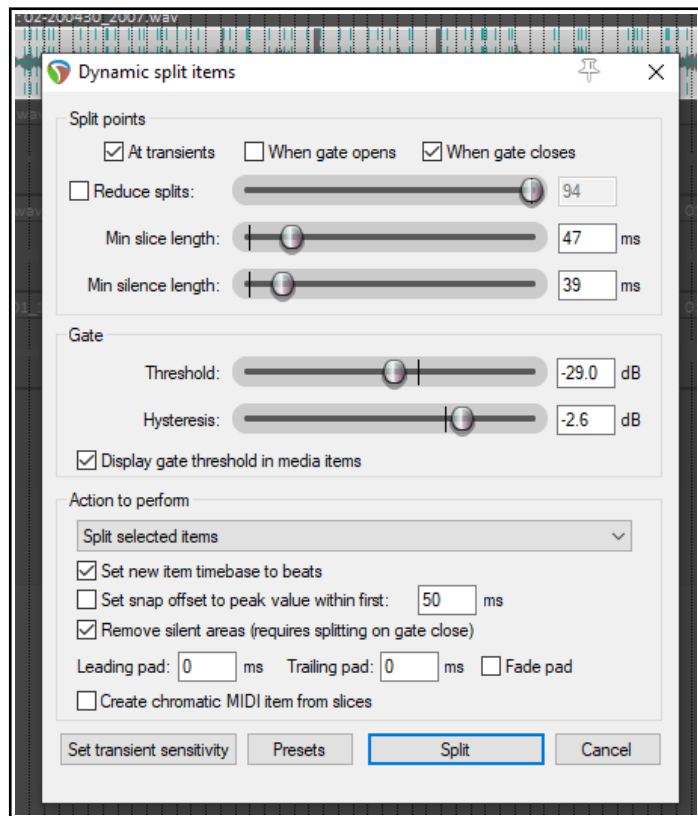

Up and Running: A REAPER User Guide v 7.31

- Under **Project Settings**, Timebase for events. You can select Time, Beats (position, length, rate) or Beats (position only). The former locks items to the timeline so that changes in tempo will cause items to be resized and their play rate adjusted. With Beats (position only), the start of the item is locked to the beat, but the item contents are not affected or modified by tempo changes.
- Under **Project Settings**, Default pitch shift mode and parameter.

Remember that you can change the timebase for individual tracks (right-click, **Track timebase**) and for individual media items (**F2**, Item timebase). You can also change properties such as Beats per Minute and Time Signature as often as needed during the song. For example, you can increase the tempo for one passage then restore it to its original setting at the end of that passage. Shortly we will see an example of how this is done.

9.14.2 Audio Media Item Properties

You can record your own media items or import them from existing files. You can also change various properties such as playback rate and pitch for individual media items.

You can specify parameter settings for individual media items and/or for selection of items. For example, if you wish to change the pitch or playback rate for several items you can select those items and press **F2** (or right click anywhere in the selection and choose the **Item properties...** command).

In the example shown, we are increasing the playback rate for the selected items by 5% and preserving the original pitch.

You can override the project default pitch shift mode. You may find that different algorithms work better with different kinds of audio item (such as vocal, snare, kick or bass guitar).

Set your **Stretch marker fade size** select your preferred mode – **Balanced**, **Tonal optimized**, **Transient optimized** or **No pre-echo reduction**.

More information about time stretching can be found in the section **Time and Pitch Manipulation**.

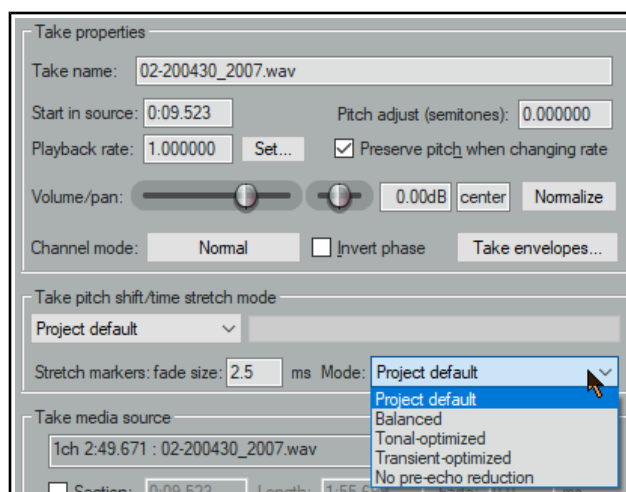

9.14.3 Creating a Loop from a Time Selection

Remember that you are able to select any part of an existing media item and use it to create a loop. This subject is covered earlier in this chapter.

Chapter 15 will introduce you to REAPER's actions and the [action list editor](#). This can be used to assign keyboard shortcuts to many actions that can be useful when you are working with loops and time selections. There are actions, for example, to extend the time selection in either direction, to reduce it from either direction or nudge it in either direction. Browsing and searching the action list will help you to identify those which are most useful to you. Chapter 15 will show you [how to bind these actions to your own shortcut keys](#).

9.14.4 Creating a Loop from Transients

Another method of selecting the area required for your loop is to use the transients in an existing media item. The following actions are just some of the many that can be found within the [Action List Editor](#) (Chapter 15). Where no existing keyboard shortcut exists, you can assign your own if you wish.

Item navigation: Move cursor to nearest transient in item	Ctrl Tab
Item navigation: Move cursor to next transient in item	Tab
Item navigation: Move cursor to previous transient in item	Shift Tab
Time selection: Extend time selection to next transient in items	

Assuming that you are using the default key bindings shown above, and that **Ctrl Alt Tab** has been assigned to **Extend time selection to next transient in items**, you can select the item, navigate exactly from transient to transient and select the exact area required. You can select the item, copy and paste it elsewhere, then right click over it, choosing **Copy loop of selected areas of items** from the context menu.

Loops, Project Markers and Regions

These are just a few of the actions and commands that can be used to suit your own method of working when creating your tempo-based projects. Explore the others and get to know them. They include:

Copy selected area of items

Trim items to selected area

Split items at prior zero crossings

9.14.5 Beat Correction

REAPER includes many actions to assist with beat detection and beat correction, e.g. to detect tempo, create measures from time selections, extend or swap time selections to the next transient, and more. Some are on the context menus and all are in the Action List. Any action can be assigned to toolbars, menus and/or shortcut keys, or run directly from the action list window. More information about all of these can be found in Chapter 15.

How you string these actions together is up to you. For example, you might have a live performance that was not done to a click. It is a simple process to go thru the track and manually tempo-map the whole performance.

Example

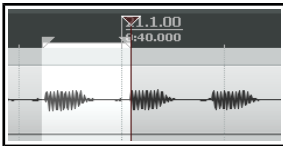

Here we have used our shortcuts to create and extend the selection out, as required. We then choose Create measure from time selection (detect tempo), either from the timeline's context menu or using the keyboard shortcut Alt Shift C.

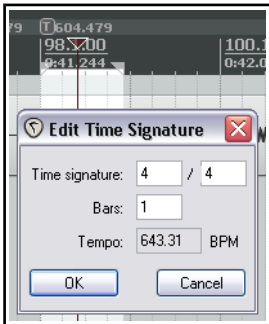

This process is repeated until we come to the first place where a change of time signature is required.



By right clicking over the timeline we display the context menu and select the command **Create measure from time selection (new time signature)...**

This causes the **Edit Time Signature** dialog box to be opened, which you can edit at will then click on **OK**.

This procedure can then be repeated up to the end of the performance.

9.14.6 Transient Detection Settings

The command **Edit, Transient Detection Settings** causes the window shown here to be displayed.

This can be used to make your transient detection sound more natural and human, by introducing subtle variations in sensitivity and/or volume threshold. Enabling the zero crossings option will help to prevent unwanted clicks.

9.15 Embedding Transient Information when Rendering

Project rendering is covered in detail in [Chapter 21](#). The

File, Render dialog includes an option to **Embed stretch markers/transient guides** when you are rendering WAV or AIF files. Note that:

- WAV does this by adding acid chunks (where *chunk* is a term of art, rather like an extension for an audio file):AIFF does this using apple loops chunks.
- REAPER calculates that tempo on export as the average tempo of the entire rendered media.
- When importing a WAV or AIFF file that has transient information embedded, reaper will recognize the information and prompt if you would like to either import the file as beat slices (exactly like rex files), or as a single item with transient markers, or just as plain media.

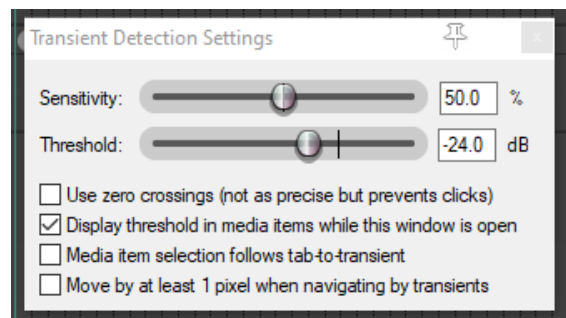

9.16 Quantizing Items

REAPER allows you to quantize your audio items. This essentially means lining them up according to the project tempo or time signature.

You might have a situation in which you have copied and pasted a sample several times within a track (or across several tracks) and you need to ensure that they are correctly aligned. To ensure that all items are aligned to the beat, you simply do this:

1. Double-click on the track in the Track Control Panel to select all the media items in the track. Alternatively, you could right click drag with your mouse to marquee or "lasso" them.
2. Right click over any of the items, then choose **Item Processing** then **Quantize item positions to grid...** This causes the **Quantize Item Positions** dialog box to be displayed.
3. Specify your required parameters, including the note length setting (1/8, 1/4, 1/2, 1, 2, etc.) and whether you want the items stretched to fit. An example is shown on the right.
4. Click on **Process** for the quantizing to be done.

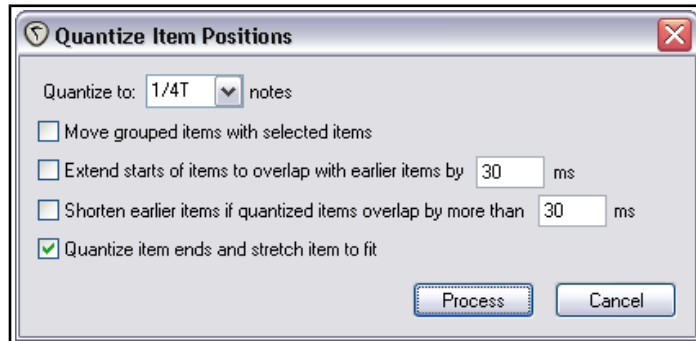

In the example above, the option to also quantize item ends and stretch to fit was enabled.

9.17 Dynamic Splitting

Dynamic splitting is a very powerful feature which has a number of applications. You have already seen (in Chapter 7) how it can be used to [remove silence](#). For example you might have recorded a pretty good bass line that you'd like to use for a song. Maybe it was recorded at 96 beats per minute. The timing might be a bit out at times but on the whole you're pretty pleased with it. The trouble is that you want to use 120 beats per minute for your new song.

Here's another example. Maybe you've recorded a killer slide guitar track. You like it but think it would be pretty clever to give the tune one or two tempo changes. Dynamic splitting is the answer to both these challenges. It works on the principle that you can instruct REAPER to split any media item (or selection of media items) according to criteria that you specify. Basically it works like this:

- You first select the media item (or items) to be split.
- You right click over the item and choose **Item processing, Dynamic split items...** from the menu.
- This causes the **Dynamic split items** dialog box to be opened.
- You give it the information that it needs to work out where to split your items.

This will essentially either be to split the track at its transients or to use a noise gate to split whenever the audio volume falls below a specified amount. As you will shortly see, each has its separate uses.

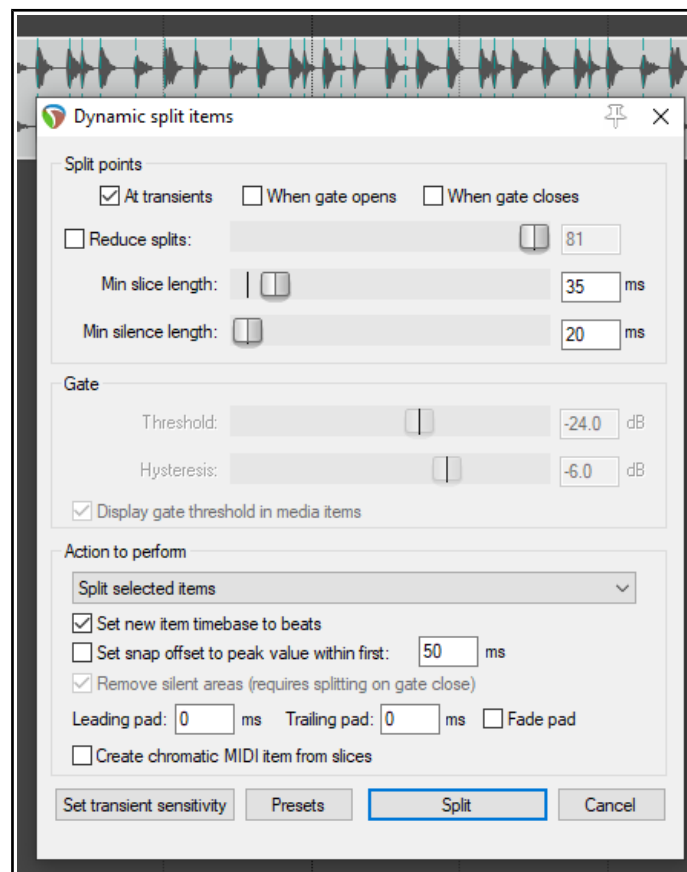

Loops, Project Markers and Regions

- REAPER then "shadow splits" your selected item(s). That is to say, it indicates with a row of colored bars exactly all of the points at which the item will be split if the parameter settings are left as they are.
- You make such adjustments as you wish to the parameter settings until satisfied that they are right.
- You tell REAPER to split the items.
- Once split, each slice of the original item will be set to the current timebase. You can set any of the splits to any other timebase you choose. You can use the items together or individually, according to your needs. Suddenly you've got a whole library of samples!

Dynamic splitting is non-destructive. This means that your original audio files (WAV, MP3, AIF or whatever) remain intact. Nevertheless, if you are going to use this method to build a sample library, it's often a good idea to work on a copy of the original track. This just makes it easier to go back to the original if you wish to use it to make a fresh set of samples. Let's now take a look at an example or two.

9.17.1 Splitting a Media Item into Samples

In the examples below, a recording of a snare is selected. We have then chosen **Item processing** then **Dynamic split items** from the context menu. Studying these examples will help you to understand how the settings work. In every case, the **At transients** option should be enabled. These examples should be sufficient to get you started. After that, it's up to you to experiment according to your particular needs.

Examples

Only a minimal number of options are used here.

If you specify a very low minimum slice length REAPER will seek out transients with a high degree of sensitivity. This will result in our media item being split into a very large number of items. This might be suitable, for example, if we are intending to introduce tempo changes to the song. The larger the number of samples and the shorter their length, the more sensitive and immediate will be the track's response to any such changes. Consider the two examples shown.

Let's see what happens when we bring some of the options into play.

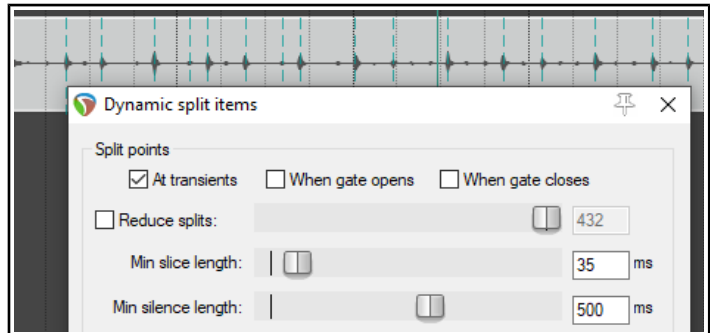

In the case shown above right we have set a largish minimum slice length with the result that our media items are quite longer. Other options have been left at their default settings. This might be appropriate if we are creating samples to be used with a software synthesizer.

However, we might want to do some more fine tuning. In this next example (lower right), we have increased the minimum slice length and used the **Reduced splits** option to further reduce the number of splits. In this particular case, these settings might be about right for creating our sample library from this track.

Before splitting it might in some instances be worth considering whether you wish to enable the noise gate settings to allow you to also remove silence. Whether you would do this would depend largely on the instrument in question and the nature of the tune and arrangement. If the instrument is played continuously and produces an audio signal similar to that shown above, then there may be little point in using the noise gate.

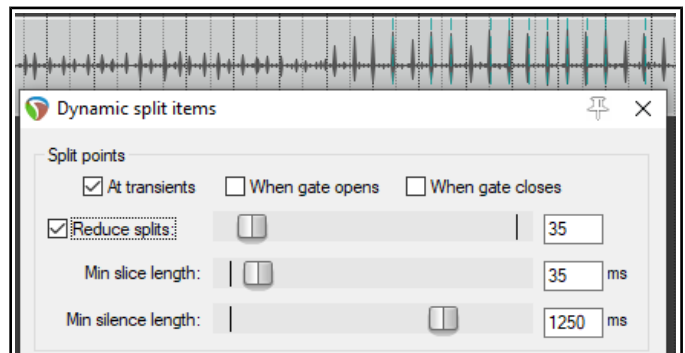

In either case, clicking on the **Split** button will cause the item to be split according to your settings. Below we can see how part of our original media item might look after splitting.

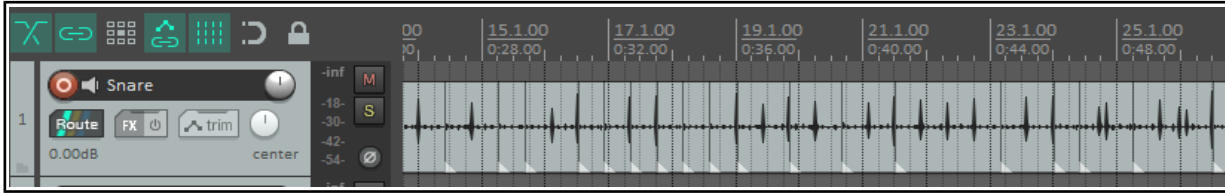

This next example (right) shows splitting at transients with a noise gate employed to remove unwanted background sounds or even the sound of the instrument decay.

In this example setting the gate threshold too low might allow too many unwanted sounds to get thru. Set it too high and we risk removing some quieter recorded material. You may need to experiment to get the settings right.

Action to perform:

These examples have all used the default option **Split selected items**.

Other options are:

Split selected and grouped items – items in any group of which this media item is a member will also be split.

Add stretch markers to selected items

Add stretch markers to selected and grouped items – stretch markers will be covered in [Chapter 10](#).

Add transient guide markers to selected items – also covered in [Chapter 10](#).

Other options:

Set new item to timebase beats

Set snap offset to peak value within first specified ms

Remove silent areas

Leading pad, Trailing pad and Fade pad

Create chromatic MIDI item from slices

The **Presets** button is used to save and recall your settings.

9.17.2 Changing the Tempo/Time Signature

When an item is dynamically split you can create time signature markers for changes in tempo and/or time signature to which your music will respond when played back. To create these:

1. Right click over the timeline and choose **Insert tempo/time signature marker...** from the context menu (or press **Shift C**).
2. Select **Set Tempo** and/or **Set time signature**. Specify your required changes in Beats per Minute or time signature.
3. If you wish, you can select the option for a **gradual tempo transition** between markers.
4. For time signature markers you can also **allow a partial measure before the marker**.
5. You can also optionally set a **metronome pattern**. For more information on metronome patterns see chapter 3, [Using the metronome](#).
6. Click on **OK**.

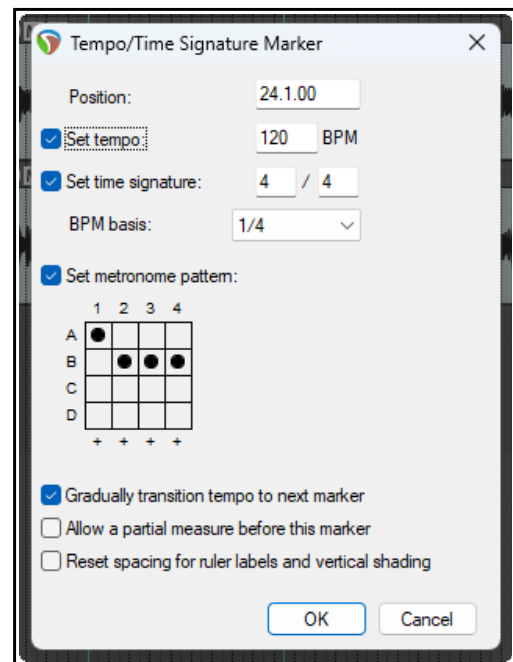
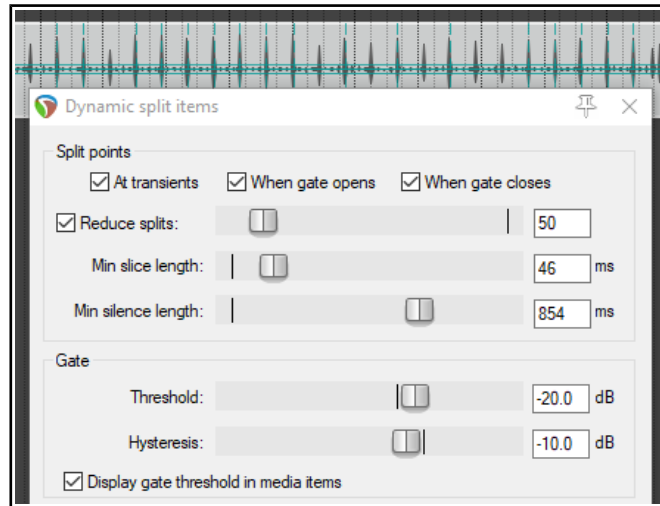

Loops, Project Markers and Regions

You can double-click on any time signature or tempo change marker to edit its settings and you can drag it along the timeline to change its position.

These settings, along with more information about time signature markers and their behavior (including editing and moving markers) can be found in [Changing the project timebase](#) and [Using Time Signature/Tempo Change Markers](#).

Note that your **Preferences. Appearance** settings includes an option whether or not to display gridlines for time signature changes.

9.17.3 Creating a Chromatic MIDI Item

When dynamic splitting you can select the option to **Create chromatic MIDI item from slices**.

This causes a MIDI item to be created that creates one MIDI event for each slice, moving up the chromatic scale. One common application of this is for sample triggering.

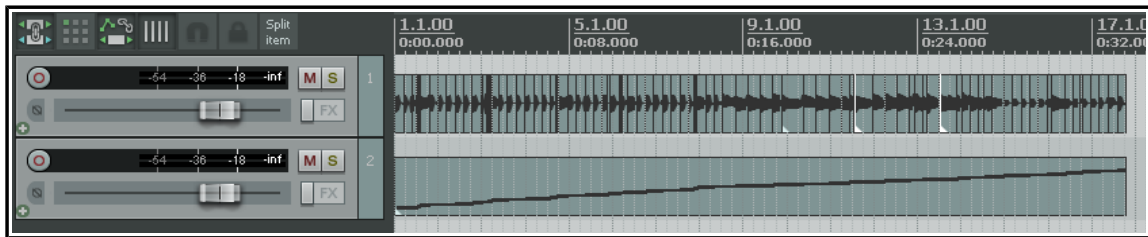

Suppose that you have a groove that you have assembled from various items from different sources. You can now create chromatic midi from the items and then load those items into a sample player, each mapped to the next note in sequence. The midi will then play the groove. Moving the midi notes around changes the groove. It is also quite easy to swap out exactly what it is that is being triggered.

Another example is hit replacement. You can dynamic split a drum part, creating chromatic midi from it. You then have one velocity-sensitive midi note for each hit. It's then a straightforward job to delete a bad hit and use the midi note to trigger a drum sample. Alternately, you can use the whole midi track to trigger a drum sample to double a recorded part (thereby fattening it).

The chromatic MIDI item can, of course, be edited like any other MIDI item with the MIDI Editor, and used to play any synthesizer or sample player. A comprehensive section on using the [MIDI Editor](#) can be found later in this User Guide, at Chapter 13.

Leading Pad, Trailing Pad and Fade Pad settings

The examples used in this section have not made use of any of these three settings.

Leading pad is the amount in milliseconds (ms) by which the split point is pushed left of the transient or gate open point when you click on Split. This works both with transient splits and gate open splits. Dynamic split works out where to split and then pads it left by your ms value.

Trailing pad pushes the actual split point to the right by the number of ms specified., and by that same value to the right of the gate close point in gated splits. The actual splits in this case will be to the left and right of the dark area boundaries if you use both When gate opens and When gate closes.

The Fade pad option, if enabled, will fade in and out over the length of those pads.

9.17.4 Saving and Using Samples

After splitting, you can save any of the individual slices as samples. To save an individual sample, simply right click over it and choose **Glue items** from the context menu. The sample wave file can then be imported for use with any VSTi sampling plug-in, such as ReaSampleomatic5000.

9.18 Ruler Layout Options

The **Ruler Layout** command on the ruler right-click context menu lets you decide what is displayed on the ruler and how it is presented.

Options pertaining specifically to regions and markers are discussed [earlier in this chapter](#). These include:

- Display project markers in lanes.**
- Display project regions in lanes**

Display tempo changes

Display time signature changes

Display tempo/ time signature changes in separate lanes.

By default both region numbers and names are shown on the ruler when the region is contained within the visible area. Three toggle options to “tweak” these are:

Display region number even if region is named

Display region number/name when region edge is not visible

Display selected regions over unselected regions when overlapping

Grid lines can be shown or not (as you wish) for project/region markers and time signature markers: these can be enabled or disabled in your [Appearance Preferences](#)

Here you can also choose whether to also **divide arrange view vertically by a specified number of measures**.

The ruler height can be adjusted using any of these methods:

- Left drag the mouse down or up on the boundary between the toolbar and the track panel.
- If you have enabled the necessary [Editing Behavior, Mouse](#) preferences option, left drag the mouse down or up on the boundary between the ruler and arrange area.
- Other options are to use one or more of the Actions List actions

Ruler: Set to default height, Ruler: Set to maximum height and Ruler: Set to minimum height.

These, like any other actions, can be assigned to keyboard shortcuts and/or toolbars if you wish.

Some general tips for managing markers (project regions/markers and time signature/tempo markers) are:

- **Alt click** on a marker to delete it.
- Click and drag a marker left or right to move it.
- Double-click on a marker to edit its settings.

Under **Preferences, Editing Behavior, Mouse modifiers** you will find various left drag actions that you can use (or change) when working with [Project marker/region markers](#) or [Time signature/tempo change markers](#).

Further detailed instructions specific to managing time signature/tempo markers can be found in the section [Time Signature/Tempo Changes and Markers](#).

9.19 REX and Similar File Support

REAPER facilitates working with files that consist of sets of groove slices, such as REX files. These are created in and exported from programs such as **Recycle**, to be used in the creation of tempo based music. You can import these files into REAPER either using the **Insert, Media** command or by dragging and dropping from the Media Explorer. When you do this, they will automatically position themselves according to the current tempo.

Once you have imported your files into REAPER, you can manipulate and use them in exactly the same ways as you can use other media items that have had dynamic splitting applied within REAPER. For example, imported REX slices can be made to keep their beat location even if the project tempo is changed.

In your Preferences settings, under [Media, Import](#), there are a number of options for how these files are to be treated. There are several options for interpreting embedded slice information, or you can choose **Always prompt**. There are also options to determine how **Slice tails** are handled. Similarly, you can specify how media with embedded tempo information is to be handled. Refer to the information in Chapter 21 more details.

The Action list also includes a useful action **Item: explode REX item into beat slices**. This can be assigned its own shortcut key if you wish.

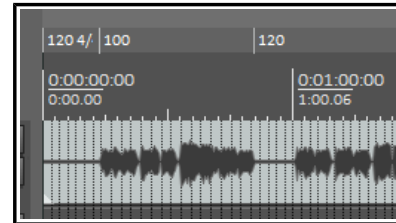

Pitch and Time Manipulation

10 Pitch and Time Manipulation

10.1 Changing the Project Play Rate

You can adjust the play rate for the whole project, using the Transport Bar. The project's default pitch shift mode will be applied. You can use any of these methods:

- Click in the **Rate** edit box and type a new value (e.g., to speed up by 10% type 1.1)
- Click the mouse in this edit box and scroll the mousewheel, up to increase or down to decrease play rate.
- Drag the horizontal fader adjacent to the play rate edit box.

You can right click over this edit box and select one of the **Playrate** options from the menu. From this menu you can:

- Reset the playrate to 1.0.
- Increase or decrease the playback rate by any listed value.
- Enable or disable the option to **Preserve pitch in audio items when changing master playrate**.
- Apply play rate to the current BPM.
- Set playrate fader range according to any available option.

The Actions List includes actions for each of these options: these can be assigned to [keyboard shortcuts](#) if you wish.

Note: If the play rate fader is not visible in your transport bar, you can display it by right-clicking over any part of the Transport Bar background and selecting the option to **Show play rate control**.

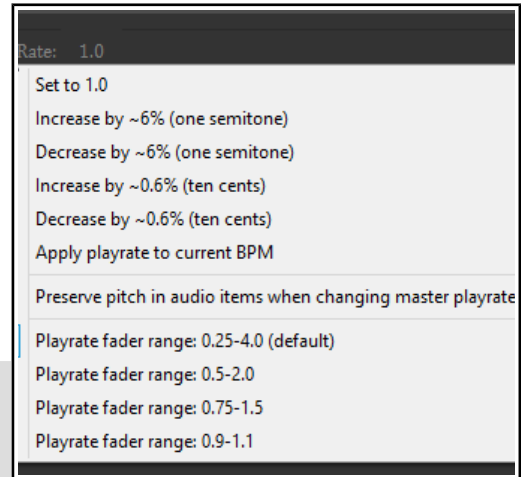

10.2 Changing Pitch for Individual Media Items

An item's pitch can be changed from the [Media Item Properties](#) dialog. To open this for any item, select the item and press **F2**. The **pitch adjust** value is measured in semitones. Enter a number to raise or lower the item's pitch, or type in a multiplier, such as **x1.5**.

Choose a pitch shift mode from the drop down list:

- Project default (from [Project Settings](#)).
- Élastique 2.2.8 or 3.3.3 Pro (best).
- Élastique 2.2.8 or 3.3.3 Efficient (less resource intensive than elastique Pro).
- Élastique 2.2.8 or 3.3.3 SOLOIST (suitable for monophonic items).
- Rubber band library.
- Rrreeeaaa.
- SoundTouch 1.9.0 (allows stretch rates up to 1,000 times and up to 128 channels).
- ReaReaRea.
- Simple windowed.

For any of the **élastique** modes, you should also select an option from the adjacent **Mode** dropdown: options will vary according to the mode selected.

Rrreeeaaa is useful if you want big stretches that do not preserve transients. Application of this mode is defined by an accompanying dropdown list which lets you change FFT, analysis and synthesis options from their defaults. It's unlikely that you would want to use this mode with stretch markers or ReaTune.

For **rubber band library**, available settings include stretch transients, detector, pitch mode and window.

ReaReaRea is similar to a classic digital sampler timestretch algorithm. It processes independent of the signal being stretched, and can be used creatively, being able to be configured in a tempo-synchronized fashion and with different fades, shapes and randomization options.

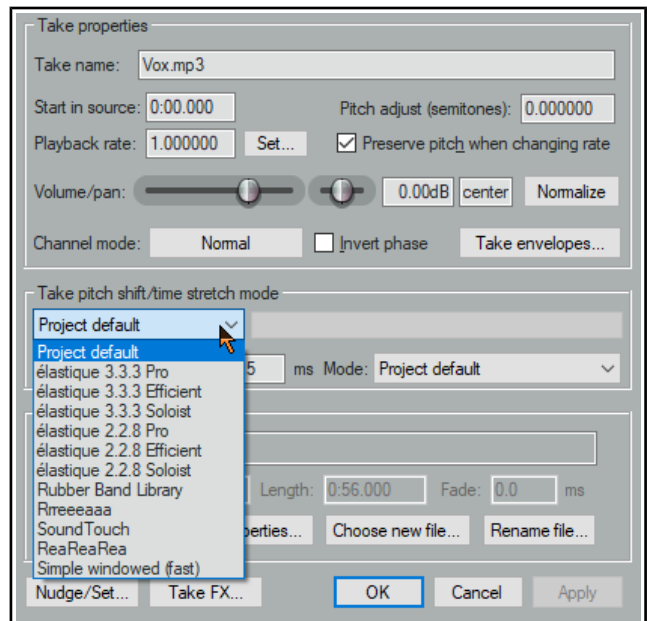

Keyboard shortcuts allow you to easily and quickly change the pitch of any selected item or group of items without needing to open the Media Item Properties box:

Shift 9: Move pitch down one semitone.

Shift 7: Move pitch down one cent.

Shift 0: Move pitch up one semitone.

Shift 8: Move pitch up one cent.

The Actions list includes an action (Item properties) to set the item playrate (tempo/bpm) from your source media.

You can also use a take pitch envelope for pitch changes.

Right click on the take (or media item if only one take) and choose **Take, Take pitch envelope** from the menu.

To adjust the pitch envelope settings, right-click on the envelope and choose **Envelope defaults, Pitch envelope range/snap** from the context menu. This opens a dialog where you can adjust the various parameters.

For more adventurous pitch shifting escapades you can try using one of the pitch manipulation plug-ins that are supplied with REAPER. Simply open the FX window for a track, click on **Add**, then in the filter list type *pitch* to discover what is available. Rubber Band Library.

One example is the **JS Pitch: an Octave down** plug-in. Search the Add FX dialog to see what else is available. The most powerful of the available pitch shift plug-ins is **ReaPitch**.

10.3 Using the ReaPitch Plug-in

Insert ReaPitch into a track's FX chain and you have a powerful pitch manipulation tool at your disposal. For example, you can use ReaPitch to create vocal harmonies.

The illustration (right) shows ReaPitch in the FX chain for a vocal track. The Elastique Soloist algorithm has been selected, together with the Monophonic parameter. The pitch has been shifted down by 25 cents and the effect panned 50% right.

You can use the **Add** shifter tab to add more shifters, each with its own independent settings (including pan and volume). Any one of these can be **Soloed**. This can be helpful when evaluating alternative options.

The **Wet** and **Dry** mix faders, however, apply to the overall plug-in.

Note: REAPER also supports the use of third party VST3 products such as Melodyne 4.2+, provided that [ARA](#) is enabled in your preferences.

Pitch Shifting/Channel Splitting

REAPER's channel splitting capabilities are explained in some detail in the section **More REAPER Routing Examples** (and elsewhere). With channel splitting, you can, for example, not only create several vocal harmonies, but also apply different FX plug-ins or plug-in chains (such as Reverb or Delay) to each of your different harmonies.

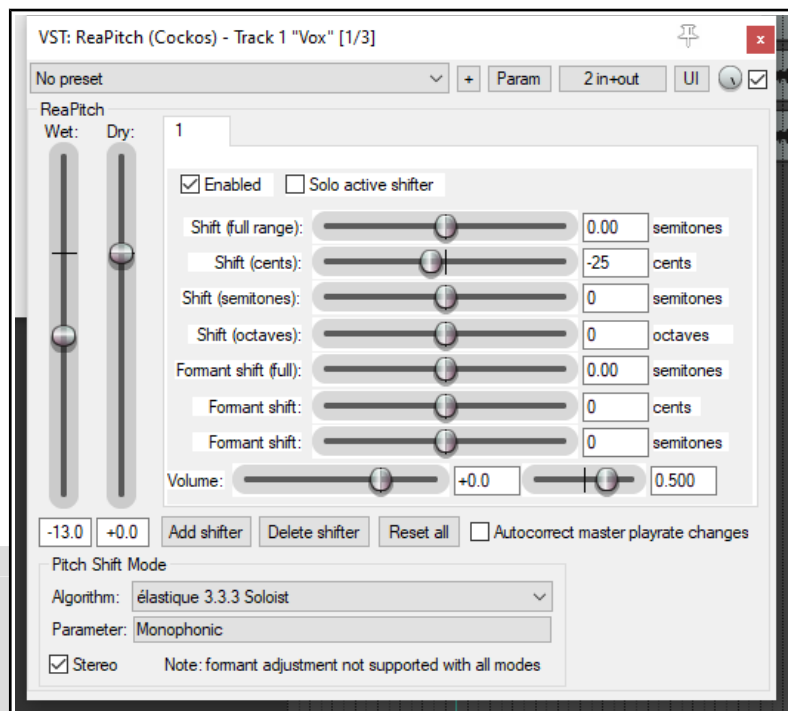
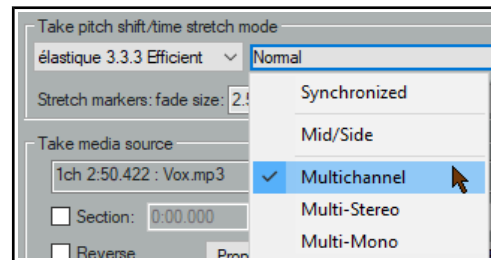
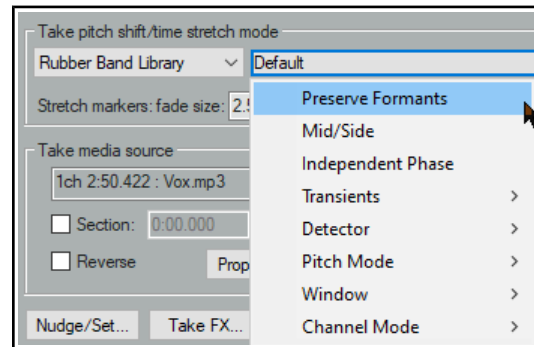

Pitch and Time Manipulation

10.4 Using ReaPitch with Multiple Tracks

We've previously looked at how REAPER can send audio streams from one track to another. Let's now have a look at how this feature might be used with ReaPitch.

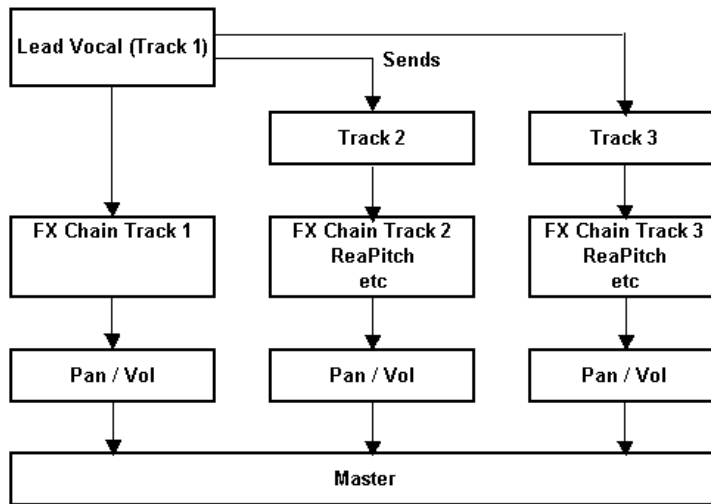

In the example shown on the left, sends are used to send a signal from a Lead Vocal Track to two other tracks.

Each of these other tracks has its own FX chain which includes ReaPitch, and of course the pan and volume faders for these tracks can be controlled independently of each other and of the lead vocal.

Chapter 17 will help you to understand how to go about setting up a signal flow such as this.

10.5 Time Stretching

The **Take properties** and **Take pitch shift/time stretch mode** sections of the [Media Item Properties](#) dialog box (**F2**) can be used to stretch or shrink the time for an item. To do this, adjust the **Playback Rate**. In the example shown (right), playback rate is being increased by 2% and the option to **Preserve Pitch** has been selected. The project default has been selected for the algorithm to be used.

To open an item's Item Properties dialog box, select the item, and press **F2**. To do this for a number of items:

1. Select all of the required items.
2. Press **F2**.
3. The **Media Item Properties** dialog will display properties where changes can be made to several items at once. These include pitch adjust and playback rate (this section is shown below right).
4. Make your changes and click on **OK**.

When the Media Item Properties dialog is opened for more than one item at once, some of the options will be dimmed and are not available when setting properties for multiple items. (such as Take envelopes and Rename file). Most options, however, are available.

Another method of adjusting the playback rate of any selected items is this:

1. Hover mouse over the end of one of the items until it turns to a double-headed arrow, as you would for slip-editing. Hold down **Alt**, click and drag mouse left to speed up playback, right to slow it down.
2. Release mouse when finished.

If you enable the option **Display media item pitch/playrate if set** (Preferences, Appearance, Media) any changes to Pitch or Playback Rate will be displayed on or above the Media Item(s) in Arrange View.

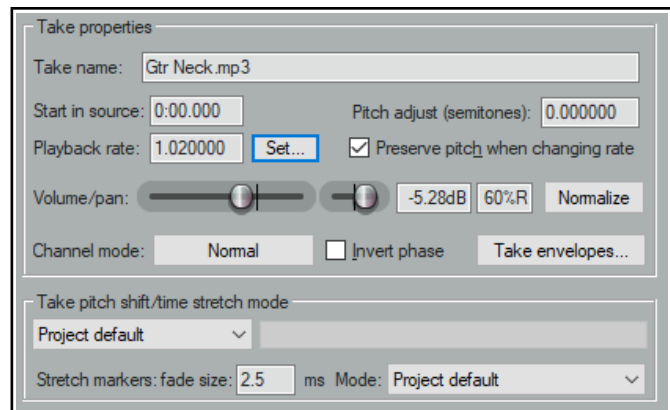

10.6 Pitch Correction with ReaTune

The plug-in **ReaTune** can be used for pitch correction, in manual or automatic mode.

To use automatic mode (top right), first insert **ReaTune** into a track's FX chain, then:

- Select the page headed **Correction**.
- Enable the **Automatic pitch correction** option.
- Select the required algorithm and parameter.
- Specify the key and play.

To use manual mode (below right) first insert the **ReaTune** plug-in into a track's FX window, then:

- Select the page headed **Manual Correction**.
- Enable the **Manual pitch correction** option, and other options as preferred.
- Enable or disable the other options as required. These are **Update**, **Prevent octave shifts**, and **Prevent overlapping segments**.
- Use your mouse (click and drag) to draw your corrections. To delete a correction, select the line and press **Delete**. The **Clear** button to clear the entire display.

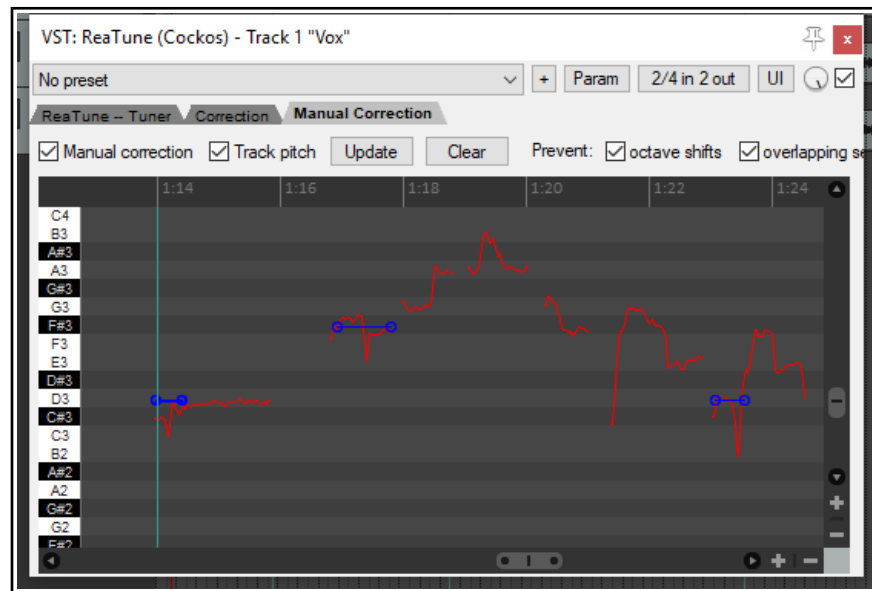
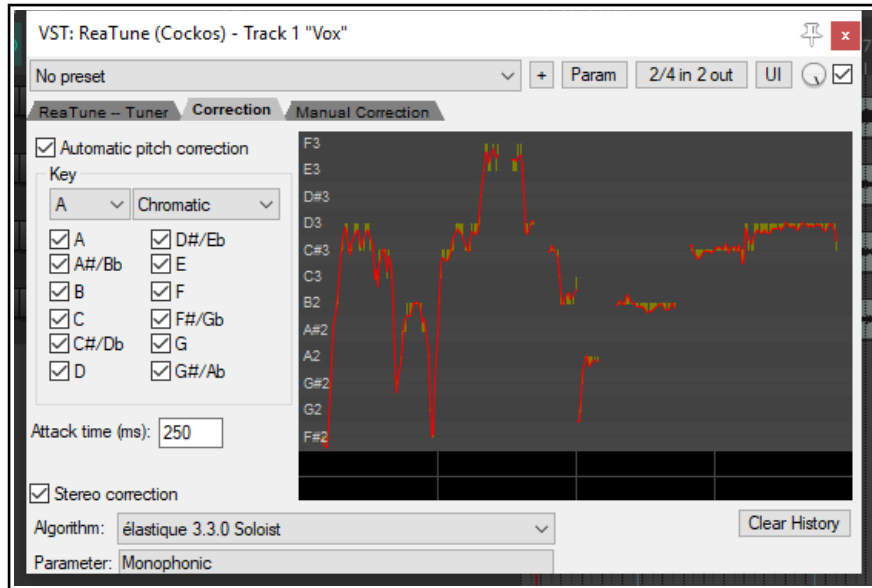

10.7 Stretch Markers

Stretch markers can be used to speed up or slow down part of an audio item or selection or group of items. They can be inserted at the current play cursor position or at the start and end of a time selection. Unlike standard project markers (which apply to the project as a whole), stretch markers are only applied to the item(s) selected at the time they are inserted. By dragging these markers left or right, the tempo of these items can be changed.

Creating and Using Stretch Markers

To create stretch markers, follow this sequence:

- Position the play cursor at the point where you want to insert a single marker, or make a time selection starting and ending where you wish to insert two stretch markers.
- Select the item or items to which you want the marker(s) to be added
- Choose **Item** from the main menu (or right-click on the item to show the context menu).
- Choose **Stretch markers** then either **Add stretch marker at cursor (Shift W)** for a single marker or **Add stretch markers at time selection** for a pair of markers at the start and end of a time selection.

Pitch and Time Manipulation

Note that as an alternative to inserting stretch markers, the **Stretch markers** menu has options to calculate transient guides: the same menu also has an option to clear these.

Hover the mouse over the stretch marker to display a horizontal (not vertical) double-headed mouse cursor as shown in the examples below. Stretch markers can then be dragged left or right with the mouse to adjust timing. Holding **Shift Alt** while dragging the first of a pair of stretch markers will move both markers together, preserving the distance and timing between them. Other modifier keys are listed on the table on the next page. Meanwhile, here are some examples showing how stretch markers can be manipulated.

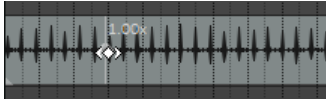

A stretch marker is inserted in this item at the position shown.

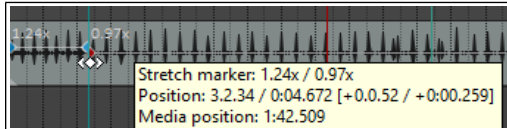

As it is dragged left, timing is made faster before (left of) the marker and slower after (right of) the marker.

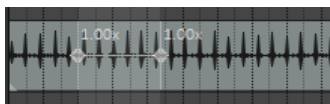

In this second example, stretch markers are added at a time selection.

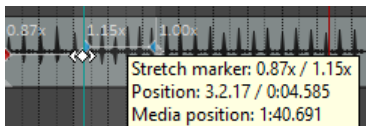

Left marker dragged right to speed up area between markers, slowing down area before. Notice new stretch markers are automatically added to the left and at the start of the item.

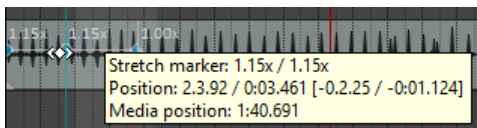

The same marker is dragged further left as Shift Alt are held. Timing before the marker changes but the timing between the original two markers does not change, as both markers and the area between them are dragged together.

Modifying Stretch Markers

If you hover your mouse slightly to the left or right of a stretch marker, your mouse cursor will change from a horizontal arrow to a vertical one. This can be used to gradually speed up or slow down playback between any two stretch markers (or before the first or after the last one) without affecting playback speed of any other part of the item. Note that one consequence of this is that the overall item length will be shortened or lengthened.

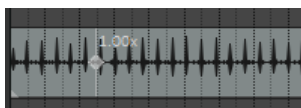

Here a stretch marker has been inserted shortly after the start of an item. We wish to gradually slow down the introductory passage without affecting anything else.

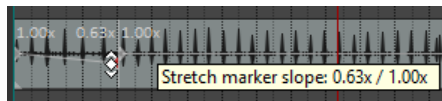

Hovering the mouse just left of the stretch marker changes the cursor into a vertical double headed arrow. We drag this downwards so that the introductory passage gradually slows down. Dragging it up would make it gradually speed up.

In the above example, holding **Shift** while dragging the mouse down would cause the item to speed up at the beginning then gradually slow down. Dragging the mouse up would have the opposite effect.

Other Stretch Marker Modifiers

Various other modifier keys can be used in conjunction with your mouse (left drag) to modify the behavior when a stretch markers are dragged. These defaults can be changed by selecting Media item stretch markers on the [Mouse Modifiers](#) page of REAPER's preferences (see Chapter 15).

Default left drag mouse modifiers for context Media Item Stretch Markers

(none)	Move stretch marker.
Shift	Move stretch marker ignoring snap.
Ctrl	Move stretch marker ignoring selection/grouping.

Shift+Ctrl	Move stretch marker ignoring snap and selection/grouping.
Alt	Move contents under the stretch marker.
Shift+Alt	Move stretch marker pair.
Ctrl+Alt	Move contents under the stretch marker ignoring selection/grouping.
Shift+Ctrl+Alt	Move stretch marker pair ignoring snap.

Other stretch marker mouse modifier choices are available from the [Mouse Modifiers](#) window, including enabling or disabling the option to act on a pair of stretch markers.

You can also use your mouse (left drag) to modify stretch marker **rates**. First, hover your mouse over the stretch markers so as to show a **vertical** double-headed arrow as in the examples below.

Default left drag mouse modifiers for context Media Item Stretch Marker Rate

(none)	Edit stretch marker rate, ripple markers.
Shift	Edit stretch marker rate.
Ctrl	Edit stretch marker rate, move contents under marker.
Shift+Ctrl	Edit stretch marker rate, move contents under marker, ripple markers.
Alt	Edit stretch marker rates on both sides, ripple markers.
Shift+Alt	Edit stretch marker rates on both sides.
Ctrl+Alt	Edit stretch marker rate on both sides, preserving marker positions.
Shift+Ctrl+Alt	Edit stretch marker rate on both sides, move contents under marker, ripple markers.

Other stretch marker rate mouse modifier choices are available from the [Preferences, Editing Behavior, Mouse Modifiers](#) window, including the option to ignore selection/grouping.

Ctrl Double-click on a stretch marker to open a dialog where you can manually edit start rate, end rate, or both, and (optionally) link start/end rates. Options can also be accessed from the context menu, using the **Stretch marker, Stretch marker at cursor** command.

In addition to the commands and mouse actions explained above, note that:

- The Item Properties dialog box includes an option to optimize stretch markers for tonal content.
- The [Dynamic Split Items](#) dialog (see Chapter 9) has an option to **Replace stretch markers**. This replaces existing stretch markers in the item(s) and replaced with dynamic splits.
- Several stretch marker **Actions** are available, for example to go to the nearest, next or previous stretch marker. For more information about REAPER's [Actions and Actions Editor](#), see Chapter 15.
- **Double-click** on a stretch marker to reset its value to 1.0.

The Stretch Markers Context Menu

- Stretch markers can be snapped to grid by choosing **Snap to grid** from the **Stretch markers in selected items** or **Snap stretch markers in selected items within time selection** options on the **Stretch markers** menu.
- A stretch marker can be removed by holding **Alt** while clicking on it. Markers can also be removed by choosing **Remove** from the **Stretch markers in selected items** or **Snap stretch markers in selected items within time selection** options on the **Stretch markers** menu. Removing stretch markers will cause an item's timing to revert to its state before the markers were added. To make any changes to the item permanent, instead of removing the stretch markers manually you can **Glue** the item (from the main **Item** menu).
- Where a number of items have been selected, markers will be added to the items in that selection. As long as they remain selected, moving one marker in the selection will also move the others. This can be over-ridden by holding **Ctrl** while dragging the marker.
- Where items have been grouped, markers added to one item in the group will also be added to other items in that group. By default they will be moved together when one is moved. This can be over-ridden by holding **Ctrl** when dragging the marker. [Grouping items](#) is explained in Chapter 7. The following example shows how stretch markers can be used with grouped items.
- Stretch markers can be any of four modes. These are **Balanced mode**, **Tonal-optimized mode**, **Transient optimised mode** or **No pre-echo reduction mode**. Your preferred default mode can be defined in the **Project settings** window.

Pitch and Time Manipulation

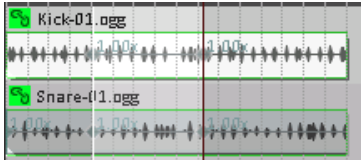

These two items have been grouped. Selecting and adding stretch markers to either causes the markers to also be added to the other.



Adjusting the marker position for one item by default makes the same adjustment on other items in the group.

Stretch Marker Actions

Finally, remember the Action List! It includes actions for every stretch marker command: these can be added to menus and/or toolbars if you wish, and/or assigned to keyboard shortcuts. In particular note these two actions: **Stretch markers at project tempo changes** and to **Clear and recalculate auto-stretch at project tempo changes**.

Neither of these appear on the media item context **Stretch markers** menu, but you could customize the media item context menu if you wish.

10.8 Time Signature/Tempo Changes and Markers

The default project beats per minute and time signature for any project are determined by the values assigned in the [Project Settings](#) window. You can make changes for the entire song by any of these methods:

- Display the Project Settings window (**Alt Enter**) and change it there, or press **W** to return the edit cursor to the start of the song, then either ...
- Type your value in the BPM edit box (shown here) or Time Signature edit box on the transport bar, or hover your mouse over the BPM edit box and scroll the mousewheel up or down.
- Make a time selection, display the ruler context menu and choose one of the options shown here.



Set project tempo from time selection (detect tempo)
Set project tempo from time selection (new time signature)...
Set project tempo from time selection (detect tempo, align items)
Create measure from time selection (detect tempo)
Create measure from time selection (new time signature)...

You can also make changes to time signature and/or tempo within a song, using either the project tempo envelope or markers. If you intend to do this, first make sure that your Project Settings are using the default timebase setting **Beats (position, length, rate)**. Pressing **Alt Enter** will display the project settings dialog and give you the opportunity to change this if necessary.

The [project tempo map envelope](#) is explained in Chapter 18. This works essentially like any other automation envelope. Note, however, that editing multiple points at once on this envelope causes each point to be adjusted *pro rata*, not by a constant BPM value.

This section focuses on inserting time signature and/or tempo change markers on the ruler to make changes within a song. An example is shown here (right). These changes take effect immediately following the marker's position. Before looking at how to do this it's worth noting that:

- Time signature markers and tempo markers are two separate entities but are both inserted on the ruler using the same method.
- At any point along the timeline you can change either the time signature, or the tempo, or both.
- By default, time signature changes are also displayed as a grid line in arrange view. You can disable this on the [Appearance](#) page of your preferences if you wish.
- If you are using either time signature markers or tempo markers it is advisable to enable the relevant **ruler layout options** (Chapter 9) to ensure these are displayed. If using both, you should consider also enabling the option to display both types in separate lanes. These options are accessed by choosing **Ruler layout** from the ruler's right-click context menu.

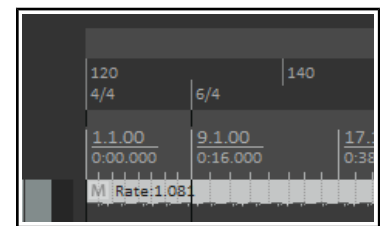

Show dotted grid lines
 Show project regions/markers in arrange
 Show time signature changes in arrange

Time Signature Markers

The various options and controls for the **Tempo/Time Signature Markers** window are explained in [Chapter 9](#). In brief, however:

Up and Running: A REAPER User Guide v 7.31

1. Position the edit cursor at the required place in the song. From the menu, choose the **Insert** command, then **Tempo/time signature marker** (or press **Shift C**).
2. Set the metronome pattern.
3. From the dialog box make your choices – e.g. set **BPM**, whether to **Gradually transition tempo to next marker** and/or **Set time signature , Allow a partial measure before this marker**
4. Click **OK**.

Alternatively, use an action to **Insert a tempo marker at edit cursor without opening tempo edit dialog**.

Remember, you can use markers to set time signature without also specifying a tempo change (or vice versa). Markers can be modified, for example by editing (double-click on marker to open the dialog) or moving them (see table below). Note also that:

- Tempo/time signature markers are by default pinned to the beat position (unless the project timebase is set to time).
- Manually editing time signature markers requires them to be placed at the start of a measure.
- With [snap](#) enabled (Chapter 7), time signature changes snap to bars, tempo changes snap to beats.
- With snap disabled (Chapter 7), moving time signature markers will modify the preceding tempo if necessary to ensure that the project contains only complete measures.
- Time signature changes that truncate the previous measure are marked with a *.
- Time signature correction may be problematic when a project contains linear tempo transitions.
- One tempo/time signature marker cannot be moved past another.
- Markers will turn red while they are being moved.

Managing Time sig/Tempo markers: to do this ...	You need to do this ...
Move a time signature or tempo marker.	Left click/drag marker.
Move time signature marker, adjusting previous tempo as necessary to preserve relative position of later tempo changes.	Left click/Ctrl drag marker.
Move tempo marker, adjusting its value and that of previous tempo markers preserving position of later tempo changes.	Left click/Ctrl Shift drag marker.
Move marker, ignoring snap.	Left click/Shift drag marker.

Footnotes:

- The above **Project tempo/time sig marker left drag** actions can be customised on your [Preferences, Editing behavior, Mouse modifiers](#) settings page.
- After time signature or tempo change markers have been added to a project you will no longer be able to set project tempo from a time selection within that project.
- The [Preferences, Audio, Seeking](#) page includes the toggle option **Playback position follows project timebase when changing tempo** – see Chapter 22.
- The ripple edit toolbar button right-click menu includes the option **Ripple edit all affects tempo map**.
- Information about file tempo and transients can be embedded in WAV and AIF files when rendering. See section [Embedding Transient Information when Rendering](#) for detailed information.

10.9 Timeline Display: Negative Timecodes

Your [project settings](#) includes an option to set project start time. Negative timecodes will be shown on the REAPER timeline/ruler before the project start time if that start time (00:00:00.00) is set to some time into the project.

For example, 10 seconds before project time zero is displayed as -01:59:50:00 because that position is in hour number -1, the first hour to the left of zero, and that position is 59:50:00 into that hour.

Every element of the timecode runs forwards, but the hour field is allowed to be negative so it runs ...-2,-1,0,1,2,... . In DF timecode mode frames are dropped predictably at the start of every minute that is not divisible by 10. There is a consistent number of frames between any two H:M:S:F positions that have the same relative difference between any two elements, for example -01:57:00:02 to 00:00:00:00 is the same number of frames as 00:57:00:02 to 01:00:00:00.

Pitch and Time Manipulation

10.10 Playback Time Offset with Routing

The track routing window includes an option to enable **media playback time offset** (click the Route button on the track): you can adjust individual tracks to play back media earlier or later. this is commonly used to account for MIDI latency but could be used for other purposes.

In addition, the Actions List now includes an action to **Convert embedded source transient information to transient guides**.

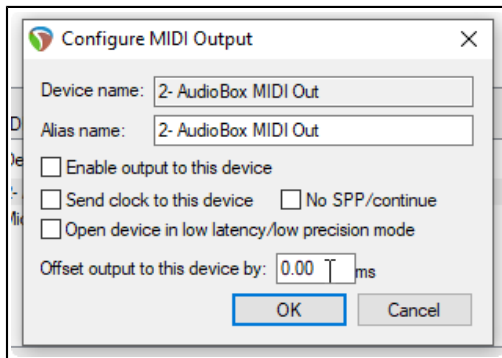
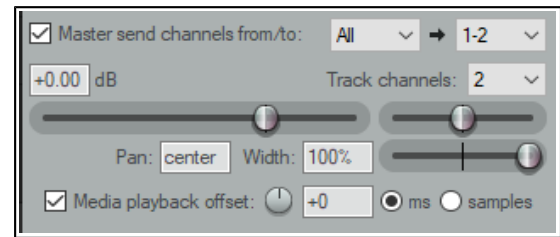

Being able to configure your MIDI output devices for optimum performance is not a new feature of REAPER. A new enhancement in REAPER 6, however, is that you are now able to enter either a positive or a negative value for output offset time.

This is entered in the Configure MIDI Output dialog, accessed by right-clicking over the output device in the **MIDI Devices** page of your **Preferences** and choosing **Configure output ...** from the context menu.

The **Playback** page of your **Preferences** now includes an option to set **Max MIDI playback speed when applying negative track playback offset**.

In addition, the Actions List includes an action to **Bypass track playback offset**.

10.11 Audio Jogging and Scrubbing

Jogging and scrubbing can help you to audition or locate a particular section within a project.

To jog a portion of a song, position your mouse over the triangle located on the top of the edit cursor, as shown on the right. The mouse cursor changes to a white hand. You can then click and drag in either direction. When jogging that you might want to zoom in quite closely on your project. By default, holding down the **Ctrl** key while jogging will enable **Scrub** mode. In this mode, playback will be much slower. This can help when looking for very short glitches.

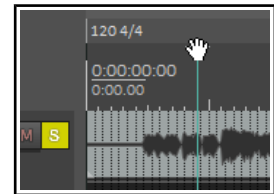

You can set your jog/scrub preferences in the [Audio, Scrub/Jog](#) page of the **Options, Preferences** window, as shown below. Amongst other options you can:

- Limit the maximum jog/scrub rates (speed) to no more than normal playback speed.
- Choose to allow jog/scrub mode to over-ride normal playback.
- Enable the **Only play selected tracks** option, so that only those tracks currently selected will be heard during jogging or scrubbing.

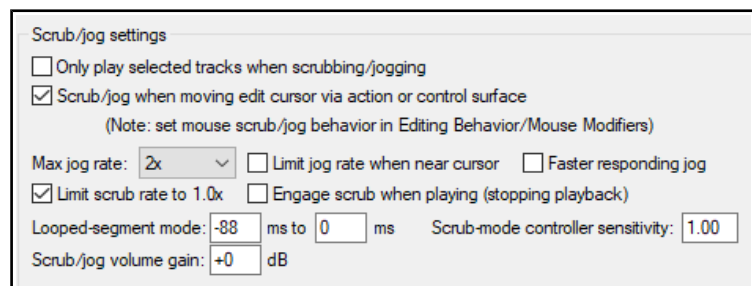

Looped segment mode can be used to audition a section of your material as a loop. For example, if in Playback preferences (above right) you specify a range of -1000 ms to 1000 ms, then holding **Alt** while you click and drag the edit cursor handle briefly left or right will jog a two second portion of audio over and over for as long as you hold down the mouse button.

You can also assign modifiers for jogging and/or scrubbing to your Arrange View middle mouse button drag behavior. For more information about assigning mouse modifier preferences see Chapter 15.

10.12 REAPER Integration with ARA

REAPER (64 bit version) now supports Audio Random Access (commonly known as **ARA**). ARA is an extension developed for use with certain VST3, AU and RTAS audio plug-ins. REAPER supports ARA compatible VST3 plug-ins, but not AU or RTAS. Note that not all VST3 plug-ins are ARA compatible.

ARA provides improved communication between the DAW (REAPER) and the ARA compatible plug-in by allowing information such as audio data, tempo, pitch, and rhythm to be exchanged for an entire track or item at a time, rather than as it is played back. This is far more efficient, avoiding the need to be constantly transferring data back and forth. The plug-in is closely integrated with REAPER, thus enabling more accurate outcomes.

Most commonly, ARA is used to enable REAPER to integrate with Celemony's Melodyne program, although there are other plug-ins that are ARA compatible (e.g. VocAlign Pro 4). Melodyne is a sound design program which offers algorithms for a wide range of types of sound (vocals, instruments, percussion, etc.) and which allows you to work on pitch, scales, tuning, timing, tempo, amplitude, and more.

Accessing Melodyne with ARA

Happily, ARA's integration into REAPER is pretty much seamless. Make sure that the option **Enable ARA for VST3 plug-ins that support it** (Options, Preferences, Plug-ins, ARA) is enabled and then restart REAPER. You can then simply access the VST3 plug-in from the FX chain window in the normal way. Here is an example:

1. Add the required plug-in (e.g. Melodyne) to the track or item's FX chain. This opens (within the FX chain) an instance of the plug-in. Double-click on the plug-in name if you wish to open it in a separate window.

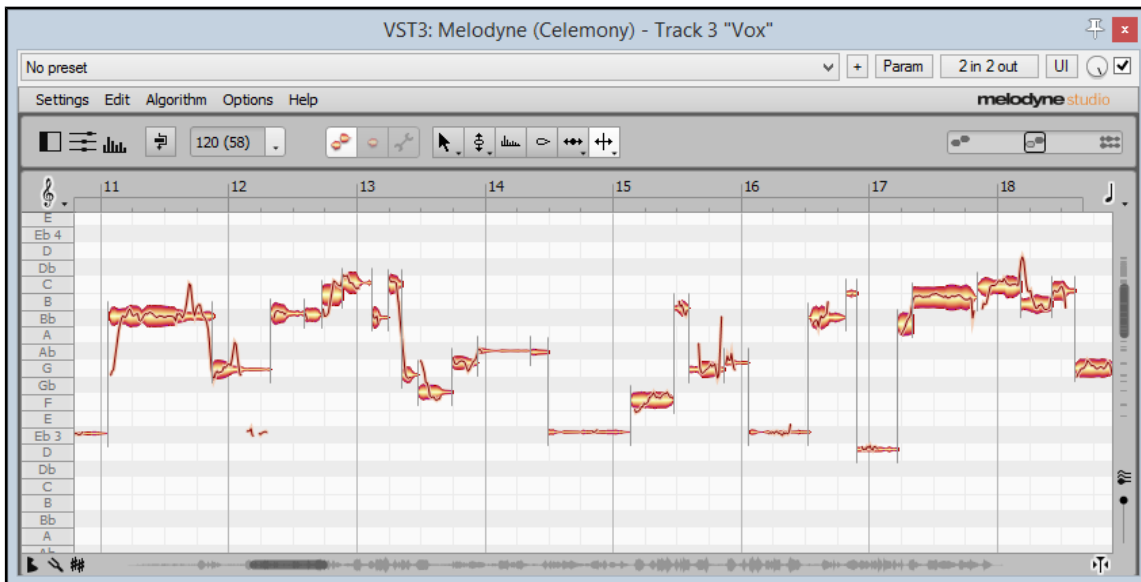

2. In the illustration above, Melodyne has been inserted directly into a take's FX chain and then opened in a separate window. In this example, the media item is a vocal take, but it could be any audio item or track, such as a guitar, bass, violin or percussion instrument. The audio material is now displayed in Melodyne not as a waveform but as a series of notes (events). Be aware that the process of initially interpreting your audio material as a sequence of events such as this can take Melodyne several minutes.
3. You can now make whatever edits you require in Melodyne and these will be applied to your audio item on playback. As with other plug-ins, the actual item itself will not be modified, although you can [stem render](#) it with the FX to a new track if you wish.

You can close and reopen the Melodyne window as often as you wish without losing your changes. However, it is always advisable to save the .RPP project file regularly and also when finished.

Tip: Edits made within the Melodyne (or other ARA plug-in) window will be recorded in your undo history, and thus can be reversed from within the Undo History window. However, if you find that an ARA plug-in such as Melodyne is straining your PC resources, you should consider enabling the option [Compatibility settings](#), **Save minimal undo states** from the presets drop down menu (see overleaf).

Pitch and Time Manipulation

Importing from Melodyne

An audio item's sequence of notes, tempo, or tempo with time signature and measure grid can be imported into your REAPER project file. After inserting Melodyne into your track(s) FX chain(s), follow this sequence:

- Within the Melodyne window, click on the + sign to the immediate right of the presets dropdown to open the menu shown here.
- ARA compatible plug-ins will display two extra commands on this menu – **ARA: align media to detected grid** and **ARA: import into project**.
- If you intend to both align the media and import tempo, it makes sense to choose the option **ARA: align media to detected grid** first.
- To import the notes into your REAPER project as a MIDI track directly beneath the audio track, choose **ARA: import into project**, then **Notes**. You could, for example, open this MIDI file in the Notation Editor if you wish.
- You also have the options to import **Tempo** or **Tempo, time signatures and measure grid**.

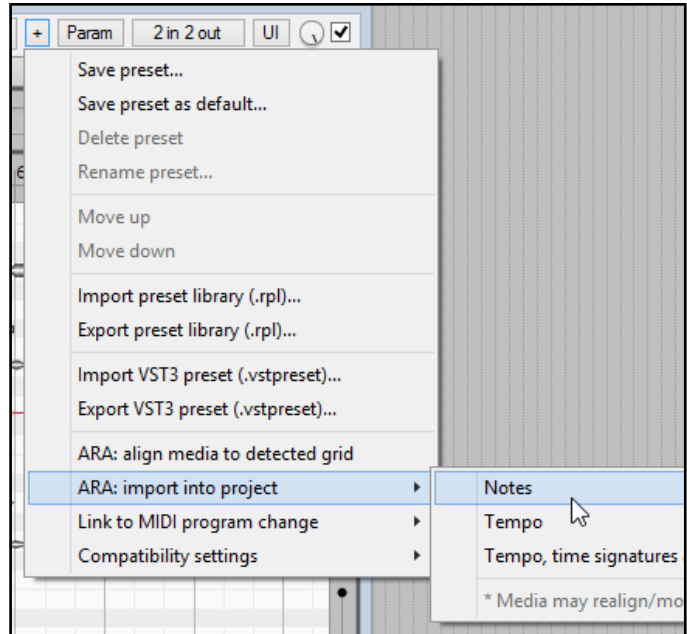

You can use Melodyne on several tracks in the one Melodyne window. Insert an instance of VST3 Melodyne on each of the tracks, then double-click on any one instance to open Melodyne in its own window. Using the track list tool (second left, below) and the track pane icons, you can display and edit at any one time the events for any one track or combination of tracks. An example is shown below.

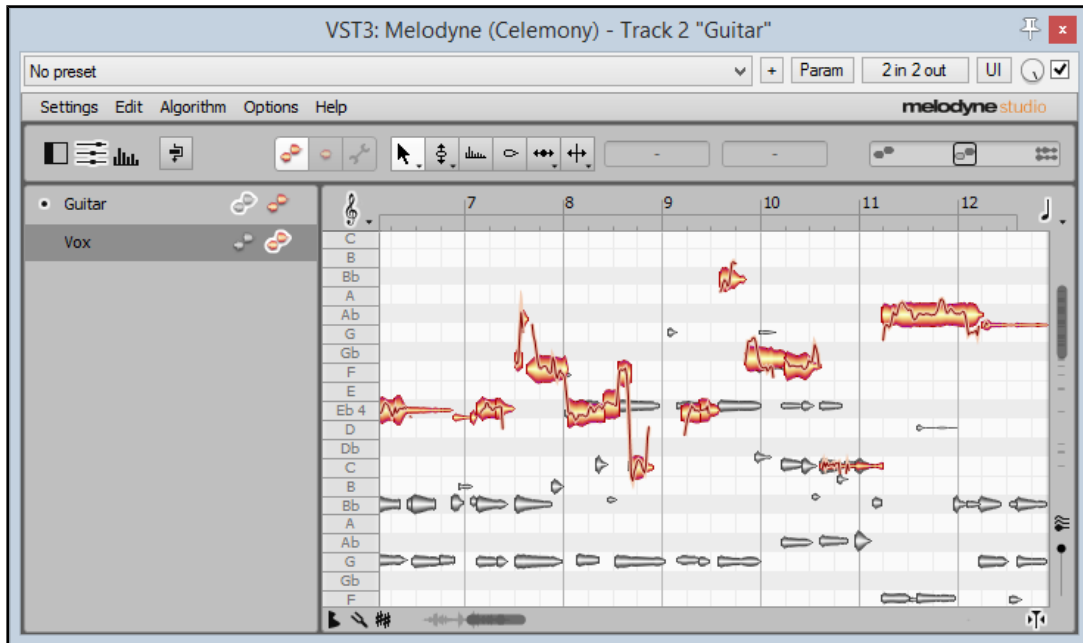

For best performance, consider enabling the option (Preferences, Plug-ins) to **Only allow one FX chain window open at a time**. You can find more about how to use Melodyne with REAPER here:

<http://helpcenter.celemony.com/daw/reaper>

The Mixer and The Master

11 The Mixer and The Master

11.1 Introduction

Until now, most of the emphasis has been on Arrange View. This is hardly surprising, as this is REAPER's core, if you like, its powerhouse. This where you comp your takes, edit your media items, manipulate your regions and so on – in short, build your projects. As your projects progress, however, you may find that the REAPER Mixer becomes more important. As its name implies, it gives you control over mixing your projects which go well beyond the suitability of Arrange View.

The contents of this section should help to familiarise you with the REAPER Mixer and its various features and capabilities. These offer you so much control over your tracks and their features. You will also learn more about how to get the best out of the REAPER Master. Mixer display is toggled on and off using the **View, Mixer** command (**Ctrl M**). The default mixer (Layout A) is illustrated in Chapter One.

Here you can see a relatively simple example of how you can customise its layout to show much more information and to give you much more control than at first sight seems possible.

You can think of the mixer as being a control center for your entire project: you can create and modify sends, add/remove FX, adjust FX parameters and more, as well as accessing all the usual track controls. If you increase mixer panel height Let's see how this is done.

First, notice that the mixer panel controls work in exactly the same way as their track panel equivalents. For example, use the volume fader to adjust volume and the pan pot to adjust panning. Click on the FX button to add FX, the solo button to solo, and so on. OK, let's begin ...

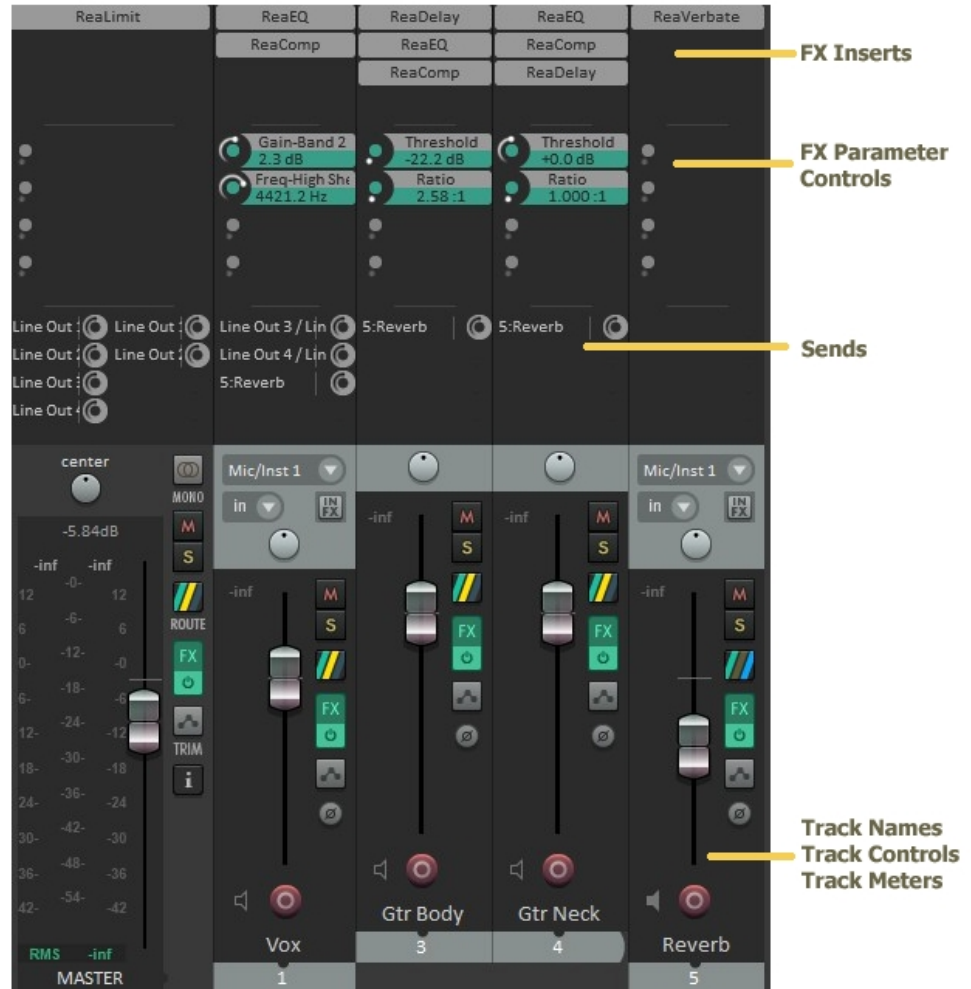

FX Management: In order to do this you do this
Make room to display sends, parameter controls, and FX inserts in docked mixer.	Hover mouse on top of panel, just above the pan pot. When you see a double-headed vertical arrow, click and drag (left drag) upwards then release the mouse.

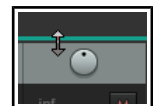

Up and Running: A REAPER User Guide v 7.31

FX Management: In order to do this you do this
Show FX above the mixer panel.	Right click anywhere in the empty area of the mixer – for example, to the immediate right of the rightmost track. From the menu, choose Show FX inserts (when size permits).
Add more FX to the panel.	Right click on any FX name, choose Add FX ... Select FX in the usual way.
Enable FX parameter controls to be shown in panel.	Right click anywhere in the empty area of the mixer – for example, to the immediate right of the rightmost track. From the menu, choose Show FX parameters (when size permits).
Select a parameter and add it to the panel.	Right click over the FX name, from menu choose Show FX parameters in panel , then select from list.
Adjust parameter value.	Left click drag up/down on button. For small movements, hold Ctrl while doing this.
Remove a parameter from the panel list.	Press Alt left click over the parameter name.
Bypass FX (toggle).	Press Shift click (shown in FX chain, right).
Set FX offline (toggle).	Press Ctrl Shift click (shown in FX chain, right).
Run FX in parallel with previous FX.	Right click on FX, choose Run FX in parallel with previous FX from menu.
Show track icons.	Right click anywhere in the empty area of the mixer – for example, to the immediate right of the rightmost track. From the menu, choose Show track icons in mixer .
Show FX parameters with their FX (toggle).	Right click anywhere in the empty area of the mixer, from the menu choose Group FX parameters with their inserts .

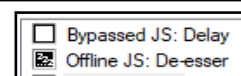

Sends Management: In order to do this you do this
Make room to display sends, parameter controls, and FX inserts (if not previously done)	Hover mouse on top of panel, just above the pan pot. When you see a double-headed vertical arrow, click and drag (left drag) upwards then release the mouse.
Show sends above the mixer panel.	Right click anywhere in the empty area of the mixer – for example, to the immediate right of the rightmost track. From the menu, choose Show sends (when size permits).
Add a send.	Drag and drop from Route button of source track to Route button of destination tracks.
Modify send parameters.	Click on send name, or right click and choose Show send parameters . Adjust to suit, then close parameters window.
Mute a send (toggle).	Shift click on send name, or Right click and choose Mute send .
Remove a send (toggle).	Alt click on send name, or Right-click on the send, choose Remove send or simply Alt click .
Adjust boundary between FX and FX inserts or between FX inserts and sends.	Hover mouse over boundary between FX and FX inserts or between FX inserts and sends. To move boundary for one track, left drag up or down. To move boundary for all tracks Ctrl left drag up or down.

The Mixer and The Master

11.2 Alternative Mixer Layouts



As with the track panel, REAPER's default theme includes three mixer layouts – A, B and C.

Layout A is the default, and is the layout used for the illustrations in this chapter so far. It shows all of the track controls.

Layout B (left) displays the controls for each track as a vertical strip, thereby enabling more tracks to be displayed in the available space.

Layout C (right) uses a side panel to show FX inserts, FX parameter controls and sends. This layout allows for the maximum amount of information to be displayed per track but has the obvious possible disadvantage of using more screen space per track.

You can select one of these layouts by choosing from the main menu **Options, Layouts, Mixer Panel** then **B** or **C**.

To restore the default layout, choose **Options, Layouts, Mixer Panel** then **Layout default**.



11.3 Tweaking the Mixer Display

The mixer right-click context menu gives you many options for tweaking your display, for example, to add an icon to folders so that child tracks can be hidden or displayed with a single click.

If the mixer is docked, this menu is also available by right clicking over the mixer's docker tab.

Menu option	Purpose
Master Track	Leads to a sub-menu of toggle options for Master Track: Show in mixer Show on right side of mixer Show in separate window Show in docker View, Floating Mixer Master (from REAPER's main menu) can be used to also display the Mixer Master in its own window.
Show folders	Determines whether track folders are shown.
Show normal top level tracks	Determines whether tracks not in folders are shown.
Show tracks that are in folders	Determines whether tracks in folders are shown.
Show tracks that have receives	Determines whether tracks with receives are shown.
Scroll view when track activated	If there is not sufficient room in Mixer view to display all tracks, the mixer will scroll to follow the TCP track selection.
Auto-arrange tracks in Mixer	Mixer track order will follow any changes to track order made in the TCP. Disable this for different orders in the MCP and TCP.

Up and Running: A REAPER User Guide v 7.31

Menu option	Purpose
Group folders to left	Places track folders to the left. This can be useful at times in bringing all your submix folders, but confusing at other times for separating folders from their child tracks.
Group tracks that have receives to left	Places all tracks with receives to the left. Especially useful if the only tracks with receives are all buses.
Clickable icon for folder tracks to show/hide children	Enables folders to be opened/closed to show/hide child tracks.
Show multiple rows of tracks where size permits	Shows tracks displayed in up to three rows when tracks will not fit in one row and the mixer window has sufficient height.
Show maximum rows even where tracks would fit in less rows	Causes tracks to be displayed in as many rows as will fit in the track height, regardless of how few tracks there are.
Show icon for last track in folder	Displays the last track in folder icon for last track in folder.
Show track icons in the mixer	Choose Show track icons from the right click menu. Use Track, Track icon, Set track icon ... from main menu to add icons.
Dock mixer in docker (toggle)	Docks the mixer in the REAPER docker.
Close	Closes the Mixer view.

Tip: Double-click on any track panel in the Mixer to toggle on and off zoom to track in the TCP. This behavior can be changed on the [Mouse Modifiers](#) page of your preferences (see Chapter 15). You can also use the **Mouse Modifiers** page to add further actions of your own. For example, you could assign **Ctrl Double-click** to the action **Track: Set to custom color ...** How to assign your own actions is also explained in Chapter 15.

11.4 Managing Parent/Child Tracks

You can see that the display options menu (above) includes several options for managing parent and child tracks when your project makes use of folders. Let's see an example of how this might work in practice.

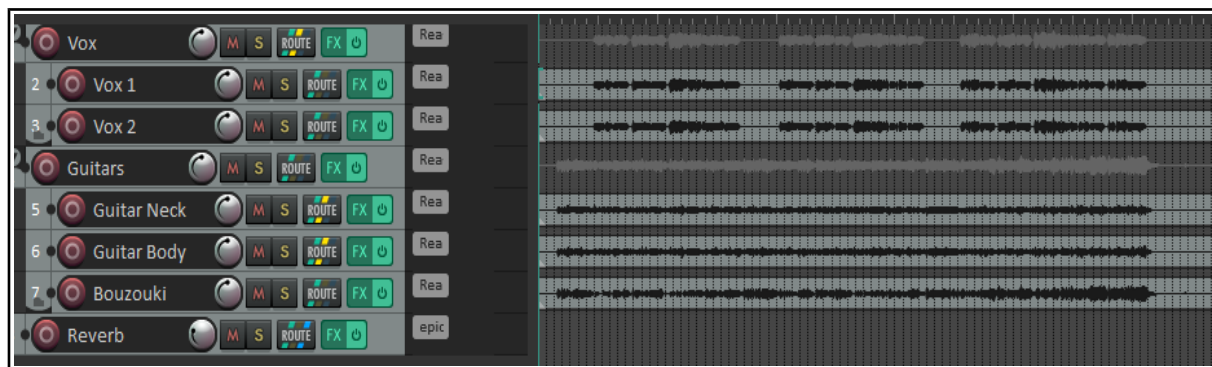

Take as an example the above project.

It has two folders (or parents) - Vocals and Guitars, containing two and three child tracks respectively - and one top level track, called Reverb. There are sends from the two folders to the Reverb track (which acts as a bus). All of the tracks have some FX in them.

The first group of four **"Show"** commands on the Mixer menu are used to determine which *types* of track are displayed and how they are displayed..

In the example shown here the Mixer is using layout A to display all tracks and folders, with indents and aligned controls, with the master on the right. The track panel is also using layout A, but that is not really relevant.

The Mixer and The Master

Now let's suppose that we wish to work with folders and top level tracks only, not displaying child tracks. Using the context menu we can deselect **Show tracks that are in folders**. The result is shown here.

The Mixer menu does not have any option to hide or unhide named individual tracks. However, this can be done using the Track Manager. The [Track Manager](#) will be explored in Chapter 12.



11.5 Working with FX in the Mixer

If you wish, you can do much of your FX management working in Mixer view. You can add FX to tracks, move or copy them from one track to another, open the FX window for any plug-in, or open the track's FX chain for more complete FX control.

For this to be possible, though, you need to enable on the Mixer menu the option **Show FX inserts when size** permits. The table below summarizes these and other activities.

In order to do this you do this
Change the order of plug-ins in the FX Chain.	Drag and drop up or down the order.
Copy FX from one track to another.	Drag and drop FX to FX area on another track.
Display FX context menu.	Right click on any displayed plug-in name.
Display the Add FX window.	Click in any vacant area of the FX area.
Display the FX chain and its control window.	Ctrl click on any displayed plug-in name.
Move FX from one track to another.	Alt drag and drop to another track.
Open and float a plug-in's control window.	Click on the plug-in name.
Remove a plug-in from FX Chain.	Alt click on plug-in name.
Remove all plug-ins from a track's FX Chain.	Alt click on track's FX button.
Toggle offline status of a plug-in.	Ctrl shift click on plug-in name.
Toggle bypass state for a plug-in.	Shift click on plug-in name.

Right-click over the FX inserts area of any track in the Mixer for a context menu. We have already introduced some of the most used commands (e.g. Add FX). Some commands (e.g. Copy FX) will not be available if you click over an empty slot. Here is summary of all the commands :

Add FX... Opens FX browser for you to add any installed FX plug-in(s),

Quick Add FX Displays a sub-menu of recently used FX: you can select any item from this menu to add to the track's FX chain.

Add FX Chain Displays a menu of FX chains, any of which you can select and insert in this track.

Replace FX... Opens FX browser for you to replace selected FX with any other: any existing routing configuration will be preserved.

Quick replace FX... Opens sub-menu of recently used FX, from which you can choose any item to replace the selected FX.

Copy FX Copies FX to clipboard so that it can be pasted to other tracks or items. Notice the option to **include automation** envelopes. You can also use **Ctrl drag** to copy from one track to another, or **Ctrl Shift drag** to copy the FX and its automation envelopes.

Show FX parameters in panel Opens up a submenu displaying all parameters associated with the particular FX. You can select any parameter(s) to display its controls in the mixer, or choose All parameters to display them all. Whether or not parameters are displayed with or apart from their host FX will depend on whether the option to Group FX parameters with their inserts is enabled.

Paste FX/ Paste Replace FX Pastes FX in clipboard to the selected track, optionally replacing existing FX.

Float FX configuration Opens the FX window for the selected plug-in.

Show FX chain (Ctrl click) Opens FX chain for the track: same as clicking on the track's FX button.

Bypass chain Sets FX chain for this track to bypass. Same as clicking on the FX enable/disable button.

Bypass FX (Shift click) Sets individual plug-in to bypass mode: it is removed from the FX chain but still works – for example, it still consumes CPU. However, no audio is passed thru it.

Offline FX (Ctrl shift click) Sets individual plug-in offline: more of a “sledgehammer” approach than bypass. The plugin is turned off (and may be unloaded). Any FX set to offline does not consume any CPU. Its previous status is restored when it is put back online.

Delete FX (Alt click) Removes this plug-in from this track's FX chain.

Rename FX instance Allows you to give an individual name to this particular FX instance.

Example

You can use one of your existing project files for this example.

1. Open one of your earlier project files, for example, **All Through the Night MARKERS** and save it as **All Through the Night MIXER**.
2. Display the Mixer. Undock it, and adjust the width and height of this window as you prefer.
3. From the Mixer menu enable **Show FX inserts when size permits** and **Show FX parameters when size permits**.
4. Insert into the first track an instance of **ReaComp**.
5. Select the **Threshold** control.
6. Click once on the gain fader control for this band, then click on the **Param** button to display the Param menu.
7. Click on **Show in track controls**.
8. Select the **Ratio** control by clicking on the gain fader for this band.
9. Click on the **Param** button to display the Param menu. Click on **Show in track controls** (see above). Close the ReaComp window.
10. In the mixer, you should see these two controls displayed for track 1. Drag and drop the ReaComp from track 1 in turn to each of the other tracks. Save the file.
11. Notice that ReaComp, with the two threshold and ratio controls, has been added to the other tracks.

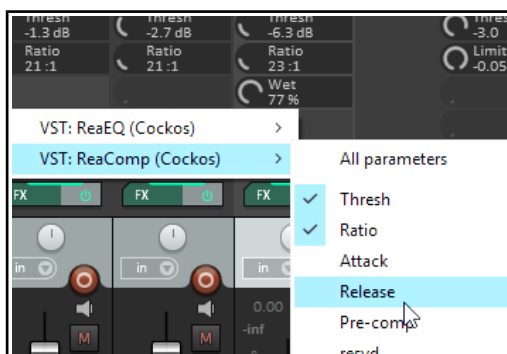
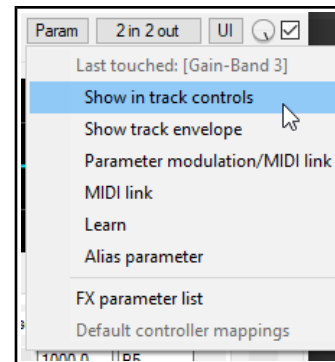

Note 1: These controls can also be assigned within the Mixer strip. Right-click in the track's parameter area, then choose from the context menu (see left). Choose **All parameters** to add a control for each of the FX parameters.

Note 2: These controls will also be added to the track control panel. You can create as many controls as you like, not just these two. This exercise is just an example.

11.6 Working with Sends in the Mixer

Enabling the **Show sends when size permits** option from the Mixer menu will cause your existing sends to be displayed, each with a small rotary fader to enable you to adjust the send volume level directly from the mixer panel. Right clicking over an existing send causes a menu to be displayed with the options shown here. Right clicking over an empty part of a track's sends area will produce a menu with only one command – **Show track routing window**. This can also be displayed by left clicking anywhere on the track's empty sends area.

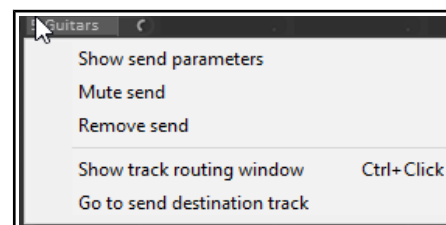

The Mixer and The Master

Show send parameters Opens a small window with parameters (volume, pan, etc.) for that send.

Mute send Toggles the send's mute status.

Remove send Deletes the send altogether.

Show track routing window Opens the track's routing window.

Go to send destination track Selects the send's destination track.

As well as this menu, other options are available for creating, editing and managing your sends. You can drag and drop from the ROUTING button of one track to another (as in the TCP) to create sends, but using the sends area of a track's channel strip for this purpose offers you more options. This can be seen in the following table:

In order to do this you do this
Add a send from one track to another.	Drag and drop from one track's send area or ROUTING button to the other. In the latter case, a send control window will be opened.
Add a send from one track to another and open control window for that send.	Ctrl drag and drop from one track's send area or ROUTING button to the other.
Add a send from one track to another and disable send from first track to the master.	Alt drag and drop from one track's send area or ROUTING button to the other. Use this method to create sends from several source tracks to the same destination track to create a traditional submix.
Add several sends to one track in one action	Select all sending tracks. Hold Shift while dragging and dropping from send area or ROUTING button of any selected track to receiving track.
Add several receives to a track in one action	Select all tracks from which you want the sends to come. Hold Shift while dragging and dropping from the ROUTING button of the receiving track (unselected) to any of the selected tracks.
Copy a send from one track to another	Drag and drop the send to another track.
Delete a send.	Alt click on the send.
Display a context menu.	Right click on any send
Open entire routing window for a track.	Ctrl click on a send <i>or</i> Click in empty part of sends area <i>or</i> Click on the ROUTING button.
Open the control window for a send.	Click on the send – allows you to change volume and/or pan, specify send/receive channels, mute etc.
Raise or lower the send volume level.	Click and drag on a send's control knob.
Toggle a send's mute status on or off.	Shift click on the send.
Add a send from a track directly to an FX (e.g. for sidechaining).	Drag and drop directly from the track's ROUTING button to the FX.

Note that in the above table, those actions which use the routing button can be carried out in both the Track Panel and the Mixer Panel.

11.7 VU Meters on Multichannel Tracks

Where a track has more than two channels you have the option of showing the output of all channels on the track's VU meters in the TCP and Mixer.

This feature is toggled on and off for any track or track selection by right-clicking over the track or mixer panel area (for example, on the track number) and enabling or disabling **Meters, Multichannel peaks** on the context menu. In the example shown here (right), this option has been enabled for the first of the tracks shown but not for the second.

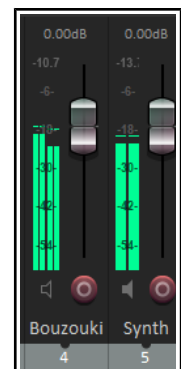

11.8 Track Control Functions

The same functions that are available in the track control panels of your track view are generally also available in the mixer control panels. These functions are covered in detail in Section 2 of this User Guide. For example:

- Tracks can be armed in the Mixer for recording.
- Clicking on a track's ROUTING button displays the track's [Routing Window](#). Right clicking on this button displays its routing menu.
- Clicking on a track's FX button displays the FX chain for that track. Right clicking opens a context menu.
- Right clicking over a track's volume or pan fader opens the Volume Control or Pan Law window.
- Similarly, the Record Arm, Record Monitoring and Select Record Mode buttons serve the same purposes as they do in Track View.
- Tracks can also be muted or soloed in the Mixer view. Both buttons use the same mouse modifiers and have the same context menus as they do in the TCP.
- Right clicking over the background area or track name or track number for any track in the mixer opens the track context menu. This includes the **Track Layout, Mixer panel** command which can be used to apply any of the layouts A, B or C to any track selection.

11.9 Stereo Panning and Dual Panning

The stereo panner and the dual panner are designed to give you more control over how you pan stereo tracks. They can also be useful with folders. The default pan mode (stereo balance/mono pan) gives you a single pan control which moves the sound between the left and right speakers.

However, a stereo track is made up of two channels – left and right. You can see these on any stereo wave file that you record or import into any project. The output of one channel (the top waveform) is normally routed 100% left, the other (bottom waveform) 100% right. Using the dual panner or the width panner you are able to change this in one of two different ways.

The dual panner (shown below right)) is the easier of the two to understand. Each of the two pan controls contains one of the channels. Pan the first of these 100% left and the second 100% right and you will hear the first channel thru the left speaker only and the second thru the right speaker only. Reverse these and you will now hear the first channel only thru the right speaker and the second only thru the left channel. Pan both fully left and you will hear both thru the left speaker only. You can adjust both pan controls independently to place each channel exactly where you want it. For example, if you set both controls dead center you will hear exactly the same mix of the two channels thru both speakers.

The stereo panner is in some respects more subtle. You can use the width control to adjust the mix of the two individual channels of a stereo media item, folder or submix, and the balance panner to position that overall mix further to the left or the right. Let's work thru a relatively simple demonstration.

Displaying the Dual Panner or Stereo Panner

Any track's dual or stereo panner can be shown by right-clicking over the pan fader and selecting the required pan mode. You are most likely to want to do this for a track which contains stereo media items, or which is a folder, or acts as a bus or submix.

Example

In this example we will first create a stereo file in order to help us experiment with the use of the width panner. We will then get a little more ambitious and use it on a submix. This will include rendering the mono media items on two current tracks a single stereo file. The topic of [rendering](#) will be covered in detail in Chapter 21.

1. Open the file **All Through the Night.RPP** and save it as **All Through the Night WIDTH.RPP**.
2. Mute all tracks except the Guitar Body and the Bouzouki.
3. Pan the Guitar Body 100% left and the Bouzouki 100% right.
4. Choose the **Render** command from the **File** menu. Rendering will be covered in detail in [Chapter 21](#). For this example, pay attention to the following settings:
5. **Source** should be **Master mix**. **Bounds** should be **Entire project** and **Channels** set to **Stereo**. Set **Output format** to **MP3**. Enable the option to **Add rendered items to new tracks in project**.

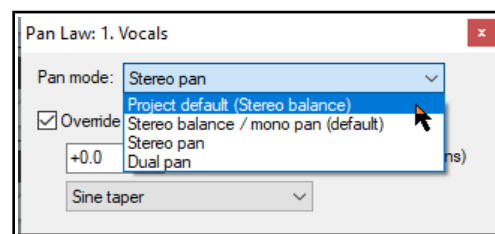
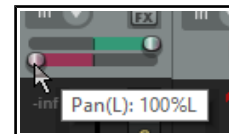

The Mixer and The Master

- Click on **Render 1 File**.
- After a few seconds, the rendered file will be added as a new track. Give the track a suitable name. It should resemble that shown here.

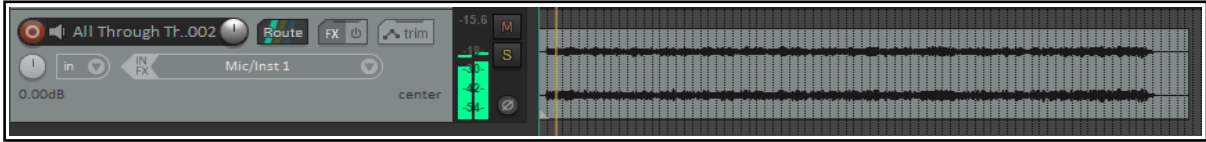

- In this rendered track, the guitar makes up the audio on one channel, the bouzouki on the other channel.
- Solo** and play this track.
- Adjust the pan control slowly, first fully left, then fully right, then back to the center. As you do so, one channel will gradually fade away. Panned full left you will hear only the guitar, full right only the bouzouki. Move the pan back to the center.
- Selected this track in the TCP, right click over the pan control and choose **Dual Pan** option from the pan mode drop down list (explained overleaf).
- Play the song. Slowly move the top pan control to 100% right. You will hear both instruments in the right speaker only.
- Move the lower pan control to 100% left. Now you will hear the guitar in the right channel only, the bouzouki in the left channel only – the opposite of what you started with.
- Experiment moving these faders. When finished, move the top pan control to 100% left and the lower pan control to 100% right. Save the file.
- Now change the pan mode for this track to **Stereo Pan**.
- Play the song. At first you will hear only the guitar in the left speaker, only the bouzouki in the right speaker. Slowly move the lower (width) panner from 100% right towards the centre (0W). As you do so, the two instruments will tend to blend more together.
- With width set at 0%, move the top (pan) control fully left. The mix will now be heard thru one speaker only. Move it back to the center. Save the file.

Now try this:

- Unsolo and mute the stereo track.
- Create a folder called Instruments just after the Vocal track. Select Stereo pan mode for this folder.
- Make the two guitar tracks and the bouzouki tracks child tracks of this folder. Adjust the volumes and pan settings of the individual tracks and the folder to get a nice mix. Pan the different tracks well apart.
- Use the width control on the folder. Experiment with using this to bring the instruments closer together or further apart. Use the pan control to position the overall mix further left or right. You can still adjust pan settings for individual child tracks within the folder as well if you wish.

Tip: This technique can do wonders when you are mixing vocals, including vocal duets and vocal harmonies!

Pan Modes

By default, the stereo width is applied before the pan/balance control. To select a different pan mode, right-click over either the pan or width control fader and choose from the drop down list. The three modes are:

Stereo Balance/Mono Pan: The track is treated as mono, even if it contains stereo media. Set to center, you hear the same signal equally thru both speakers. Set hard right, you hear it in the right speaker only.

Stereo Pan Lets you control side (pan) and width separately. Side means that the stereo image is set more to the left or right, and width means how far apart the left and right channel are in the stereo image. With side set to center and width set to 100%, you hear the left channel in the left speaker and the right channel in the right speaker. With side set to center and width set to 0%, you hear both channels equally in the left and right speakers. With side set hard right, you hear both channels equally in the right speaker, regardless of width setting.

Dual Pan: Controls each channel separately. The left and right knobs set their respective channels more left or right. With left set hard left and right set hard right, you hear the left channel in the left speaker and

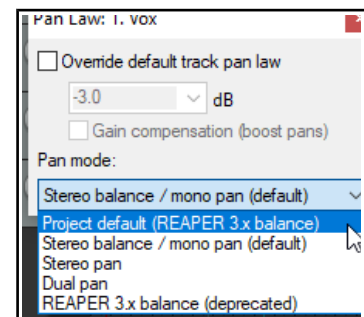

Up and Running: A REAPER User Guide v 7.31

the right channel in the right speaker. With left and right both set to center, you hear both channels equally in the left and right speakers. With left and right both set hard right, you hear both channels equally in the right speaker.

11.10 Master Track Options and Settings

The mixer Master Track main controls have the same functions as the Master Track which can be shown via the Track Master in track view. Note the Output button (shown right):



- Left click on the Output button to toggle between Stereo (gray) and Mono (orange) modes.
- Right click on the Output button to set any one of four available Mono modes – Left + Right, Left only, Right only, Left - Right.
- Left click on the FX button to display the master FX Chain.
- Right click on the FX button for the Add FX context menu.
- If the Master FX chain is displayed, then you can use all and any of the FX management keyboard shortcuts that you can use on your tracks.
- Right click on the VU area to display controls to manage the VU meters display settings (right). Meter options for the master when displayed in the TCP are Peak or Loudness: for the mixer, these are Peak + Loudness (as shown here), Loudness Only or Peak only. Options for loudness meter display are:
 - RMS (Root Mean Squared) stereo/max or RMS/Max only
 - Loudness Units relative to Full Scale momentary (LUFS-M)/max
 - LUFS-M/LUFS-I (integrated) LUFS-S (short term) /current
 - LUFS-S/ max (loudness range) LUFS-S/LRA
- Optionally, you can choose for gain reduction to be displayed on the meter (as a vertical bar descending from the top, as shown below right). This can only be shown when you are using a third party or native plug-in (such as ReaLimit) that calculates gain reduction and reports it to the host.
- Readout can be set to LUFS-I or Maximum.
- LUFS, RMS and Peak issues are explained in [Chapter 6](#).
- There is an option to display multichannel peak metering.
- Settings, where appropriate, available for managing the window include RMS window, Display offset, Display gain and Red threshold.
- This includes the option to display output in multichannel mode (e.g. when working with surround sound). Disabling this option will ensure a two channel display.

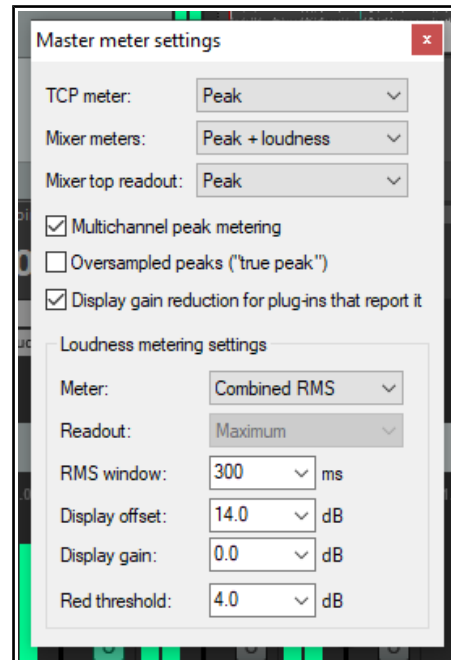

Loudness meter settings include:

Meter display: Stereo RMS, Combined RMS, LUFS-M, or LUFS-S.

RMS Window: the length of time (in milliseconds) that should be used for RMS calculation.

Display offset: this offsets the coloring of the RMS metering while keeping the position constant.

Display gain: this applies gain to the RMS meter value: for example, if you set display gain to, say, 6dB, a sine wave will show the RMS value at a higher meter reading than the peak value.

Red threshold: this determines the level at which the meter will turn red.

In the example shown above, if you were targeting -14dB LUFS or RMS, then with display offset at 14dB the display would go green at -14dB, and with red threshold 4.0dB, it would go red at -10dB.

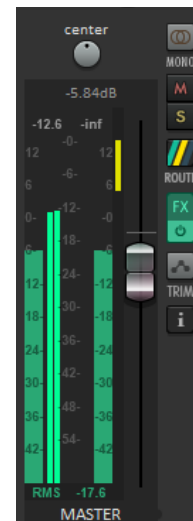

Note: There is an option in **Appearance, Track Meter** settings to scale gain reduction from plugins by a level that you can specify.

The Mixer and The Master

11.11 Master Hardware Outputs

Output from the master can be directed to one or more of your available hardware outputs. This can be done using the routing matrix. The master routing button (in the Mixer) can also be used to set up and manage your hardware output or outputs.

- Right click on the ROUTING button to display a menu of hardware output options. These can be toggled on and off in any permutation that you require.
- Left Click on the ROUTING button to display the master track outputs window. This can be used to control the levels and panning of the signals to the hardware outputs.

Notice (below) that for each output you can independently control any or all of the following:

- | | |
|---------------------|-----------------------|
| Toggle Mute on/off. | Toggle phase invert. |
| Set Volume level. | Set panning position. |

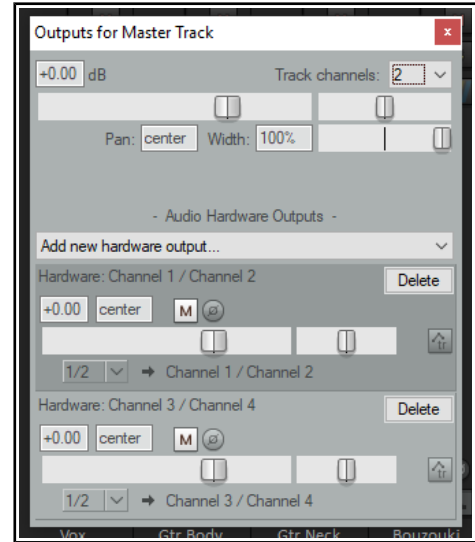

11.12 Master Track Channels

The topic of routing and channel splitting is one that recurs throughout this user guide. The concept itself starts as a relatively simple one, but from those simple beginnings it can grow into something as complex and as complicated as you like. You'll find no shortage of examples in Chapter 17.

You can use channels to send two copies of the same signal to two different places. You can then do separate things to each signal before joining them up again. Below is a relatively simple example. The example itself may or may not be something that you'll ever want to do, but that's not the point. The point is that it will help you to understand what channel splitting is about and how to do it.

Let's take an example of using multiple channels (two stereo pairs in fact) for our master. We can use this to feed some effect (such as reverb) into our signal chain, then send the effect (and only the effect) out to our headphones (to enable us to assess it), while sending the overall final mix to our speakers. In order to work thru this example, you will need a sound card with at least four audio outputs.

Example

This exercise will almost certainly be too complex for the novice user, and as such is recommended for the more experienced only. Otherwise, you might wish to return to it after you have completed Chapter 17.

This diagram shows what we are going to achieve. It assumes that our audio signal flows from left to right. First we will create the necessary extra Channels for the Master Track.

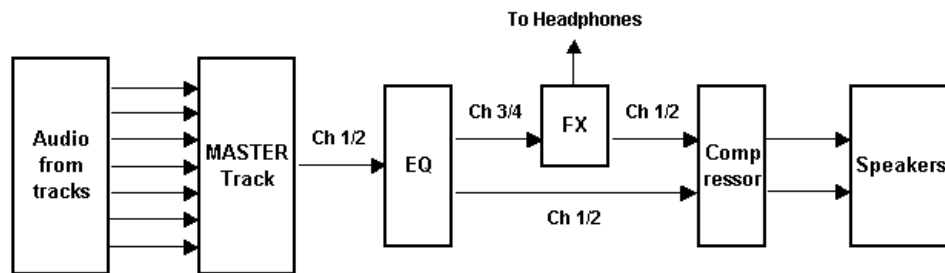

The audio coming into our Master from the mix will be split between Channels 1/2 and Channels 3/4. The signal that is passed to Channels 3/4 will be fed thru a Reverb plug-in then directly out to our headphones. It will also be passed back into a Compressor plug-in, where it will be mixed back into the original incoming signal. The final mix will then be fed to the speakers.

1. Open the file **All Through The Night.rpp** and save it as **All Through The Night MASTER.RPP**.
2. Pan the two guitar tracks roughly 40% left and 40% right respectively. Pan the Bouzouki about 15% left, the Vox around 10% right. Quickly adjust the volume levels for each track to suit, especially to avoid clipping in the Master. Save the file.
3. View the Mixer and enable the options to **Show FX inserts when size permits** and **Show sends when size permits**.
4. Make sure your Speakers and Headphones are each connected to different paired sound card outputs.

For a bound hard copy of the latest version of this User Guide (printed in B&W) go to LULU.com

- Right click over the **ROUTING** button in the Master and make sure that output is directed both to your speakers and to your headphone amp.
- To create the required channels, left click on the **ROUTING** button for the **Master Track** and set the number of channels to 4 (as shown, right).
- Assign the output of channels 1/2 to your studio speakers and 3/4 to your headphones. Your settings should appear similar, but of course not identical, to those shown here.
- Play the song. For now, it should be heard over the speakers, but your headphones should still be silent.

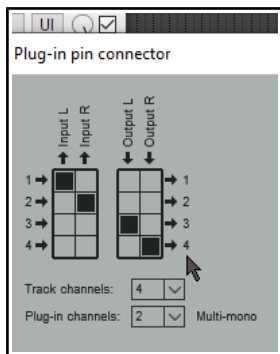

- In the Master FX chain, add the plug-in **ReaEQ** and, for the purpose of this exercise, add a 2 dB gain on Band 2, a 1 dB drop on Band 3, and a 1dB gain on Band 4.

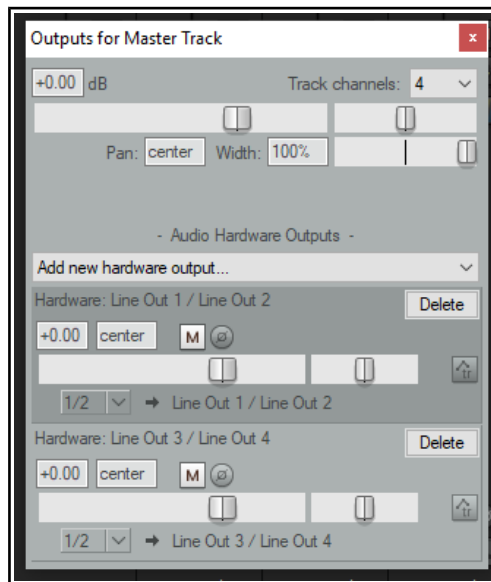

- In the Master FX chain, click just below the ReaEQ and add **ReaVerbate**. Leave the parameters at their default settings. Click on the FX In/Out button to open the pin connector. Adjust the outputs from this plug-in so that they are directed left and right respectively to channels 3 and 4 only. The settings for these outputs are shown (above left).

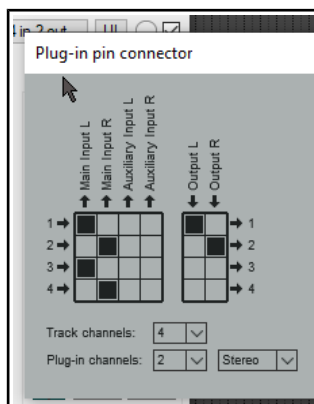

- Now play the song. The playback thru the speakers will include the effects of **ReaEQ** but not **ReaVerbate**. In contrast, if you listen thru the headphones, you will hear only the reverb.
- Now click again in the master FX chain and add **ReaComp** after the reverb plug-in. Adjust the pin connector settings for this plug-in so that Channels 1 and 3 are the Main Input for the left, and channels 2 and 4 are the Main Input for the right, as illustrated (left).
- Play the song. You can adjust the amount of reverb in the mix by adjusting the vertical **Wet** and **Dry** faders in the **ReaVerbate** window. You can also adjust the **Threshold** (vertical fader on the left) and **Ratio** settings for **ReaComp** if you wish.

- Your speakers will now play the output signal from your Master Track's FX chain, including the reverb mixed in. Your headphones will still play only the

direct output of the **ReaVerbate** plug-in. Save this file.

Managing The Overall Project

12 Managing The Overall Project

12.1 Introduction

This chapter covers some of the features of REAPER which are useful when managing your project as a whole rather than focussing on individual tracks or items. Some of the illustrations in this chapter use REAPER 4 theme and colors. The information and instructions, however, are still valid for REAPER 5 and REAPER 6.

Remember that this document uses the shortcut keys for PC (Windows) users: macOS users should refer back to [Chapter 1](#) if you are unsure of the equivalent keys to use.

12.2 Project Timebase, Time Signature and Related Settings

Basic project settings are initialised and managed in the **Project Settings** window. This can be accessed by pressing **Alt Enter**.

These settings include project BPM, time signature, and timebase. Timebase options are time, beats (position, length, rate) or beats (position only). Options for tempo/time signature envelope are time, beats or time signature beats.tempo.time.

Project start time and start time measure can be changed within the project settings dialog, but a simpler method is to use the timeline ruler's context menu.

- ◆ Position the edit cursor at the point where you wish to make the change.
- ◆ Right click on the ruler timeline and choose **Change start time/measure** from the window.
- ◆ Make your choice from the sub-menu (shown right) to **Set 0.00 to current edit cursor, Reset project start time, Set measure 1 to nearest measure to current edit cursor, or Reset project start measure.**

There are other options on this menu which enable you to set the project tempo or create new measures from a time selection.

These commands together with their various options are shown here (right).

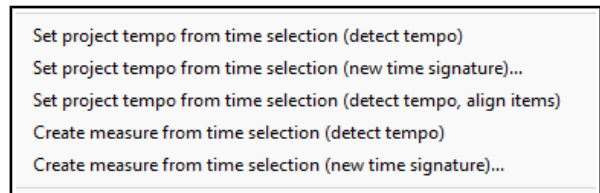
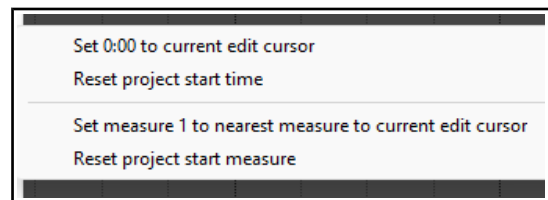
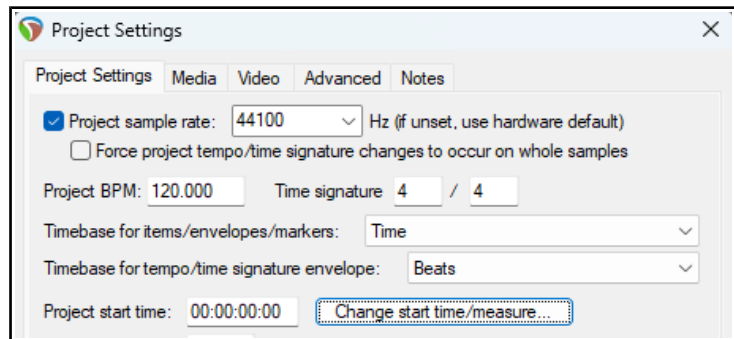

12.3 Crop to Selection and Remove Contents of Selection

When recording, it's not unusual to end up with a period of silence before your song starts, and/or periods of silence at the end of your tracks, where you have allowed the recording to continue longer than necessary. You could fix this by slip-editing your tracks individually, then dragging and dropping them to the start of your timeline. A quicker way would be to **Crop project to selection**. This removes the unwanted portions.

To do this, first click and drag along the background area in arrange view to make a time selection of the area that you want to keep. Then, right click over the Timeline and choose **Crop project to selection** from the menu. If you wish, press **Esc** when this is done to remove the time selection.

Tip: If immediately after cropping to selection (and before pressing **Esc**) you again right click over the Timeline and choose **Zoom selection** from the context menu (or use the shortcut keys **Ctrl Numpad Plus** your project will expand horizontally to fit the width of your Track View window.

Another situation might be in which you wish to remove a passage from the body of your recording without creating a "hole" in your project, or some tracks getting out of sync with others. In this case you can make the time selection in arrange view, then right click and choose **Remove contents of selection (moving later items)** from the context menu.

12.4 Project Lock Settings

The Locking feature of REAPER can be used to effectively freeze certain aspects of a project file to prevent something accidentally being changed or deleted. There are two aspects to locking:

- Deciding which project elements you would like to be locked.
- Enabling or disabling the locking feature. The keyboard shortcut **L** can be used to toggle this on and off.

To display the Lock Settings window (shown right), press **Shift L** or right click over the lock button (the last item) on the toolbar. The table below summarises some of the ways in which you are able to make use of this feature. Select which ones you wish to lock, then **Enable locking** to actually lock them.

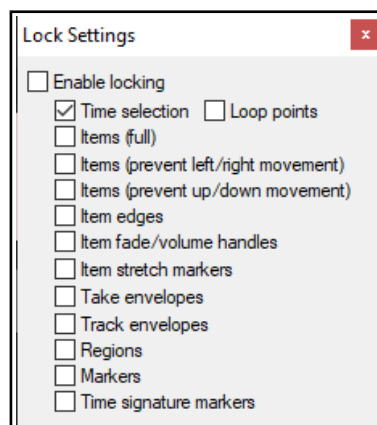

Locking Option	Comment
Time selection	This locks the current time selection so that, for example, if you accidentally click and drag at some other point along the timeline your time selection will remain unchanged. You can remove a locked time selection by pressing Esc then selecting OK when prompted.
Loop points	Locks currently selected loop points.
Items full	This option prevents you from making any changes at all to any of your existing media items. For example, you cannot mute them, add FX to them, delete them, move them, slip edit them, or even access the Item Properties window or right click menu for any of your items.
Items (prevent left/right movement)	This option allows you to make any other changes you like to your media items except move them left or right.
Items (prevent up/down movement)	This option allows you to make any other changes you like to your media items except move them up or down.
Item edges	This option disables actions such as slip editing.
Item fade/volume handles	This option can be used to prevent any adjustments being made to any item's volume handle or rotary fade controls.
Item stretch markers	This option can be used to prevent any changes or movement from occurring to any item's stretch markers.
Take envelopes Track envelopes	This option ensures that when locking is enabled you will not be able to make any changes to existing take and/or track envelopes. For example, you will not be able to move or add points, or change shapes. You will still be able to add new envelopes for faders and plug-in parameters, but you will not be able to edit these in any way. For more about envelopes see Chapter 18.
Regions	Locking regions prevents you from changing (for example by moving, deleting or renaming) existing regions. However, you will be able to create new regions with Lock Regions enabled.
Markers	Locking markers prevents you from changing (for example by moving, deleting or renaming) existing markers. However, you will be able to create new markers with Lock Markers enabled.
Time Signature Markers	Locks time signature markers and prevents them from being modified.

Managing The Overall Project

12.5 The Theme Development Tweaker

Chapter 15 covers REAPER's [action list editor](#) in detail. One action that you might find useful is the action **Theme development: Show theme tweak/configuration window**.

From the main menu choose the **Actions, Show action list...** command. Type *tweak* in the filter window then select and **Run** the action **Theme development: Show theme tweak/ configuration window**.

This will allow you to change the colors assigned to various elements, independent of the [theme adjuster](#).

Themes consist primarily of three elements: image files, color/font definitions and Windows settings. Image files provide, for example, the track control items and media item icons (pan and volume faders, mute and solo controls, etc.).

Definitions apply to items such as the fonts and colors used for media items, track/mixer panels, edit and play cursors, markers, VU meters, envelopes, etc.

Use the filter box at the top to help find those items that you wish to change. For example, typing *item* will find all elements relating to items. This find feature also supports advanced command syntax using operators such as AND, OR and NOT. For details of these and how to use them, see the section [Using Search Filters](#). Selecting an item will display the color picker where you can select a color of your choice. (Note that the terms ruler and timeline are synonymous: you can search for *ruler OR timeline*).

If you are not sure what any of the listed items are, you can use the **Theme element finder** to identify them (see below). To display this, enter *theme* in the action list filter window then select and **Run** the action **Theme development: Show theme element finder**.

In addition to those installed with REAPER, many themes are available for download from stash.reaper.fm. To install a downloaded .ReaThemeZip file, drag and drop it from Windows Explorer into REAPER's Arrange View (main view).

The **Load Theme ...** button (in the theme development/tweaker dialog) can be used to select any available theme. Scroll thru the **Theme color/font settings** list to see all of the items which you can change. Click on any item to open (as appropriate) the color picker or font dialog box, where you can change its definition.

Finally, having chosen your fonts and colors, you can save them all together into a new theme by clicking the **Save theme...** button and giving the modified theme a name.

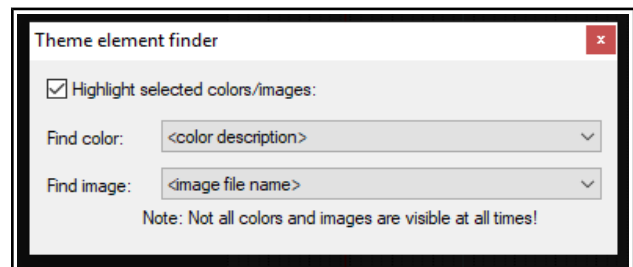
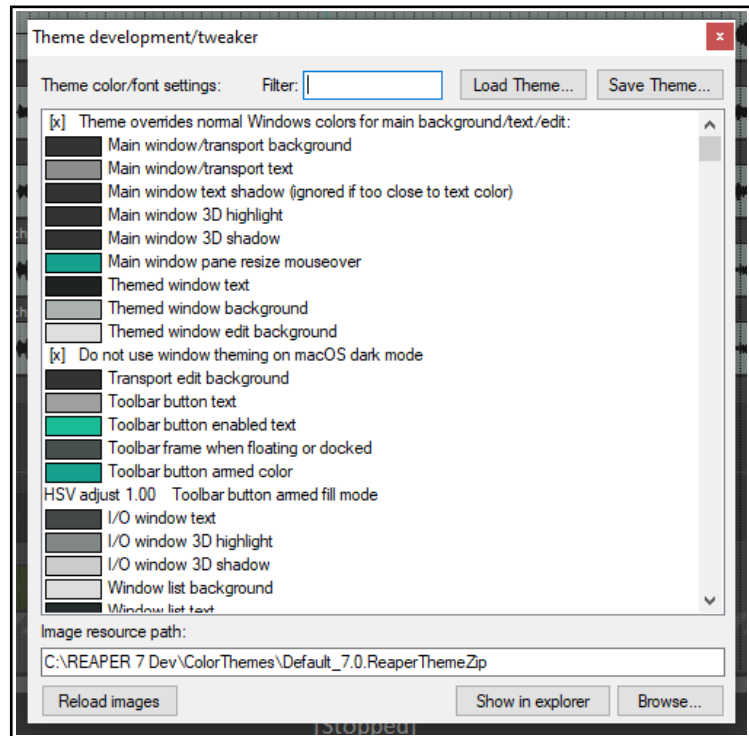

12.6 The Project Media/FX Bay Overview

The **Project Media/FX Bay** is a one stop center which you can use for managing and arranging a project's FX and media items. It is opened from the main menu by the **View, Project Media/FX Bay** command. The window contains seven tabs (pages). The [Item Groups](#) (Chapter 7) and [Take Comps](#) (Chapter 8) tabs have already been introduced. [Automation Items](#) are explained in detail in Chapter 18. The others are:

Up and Running: A REAPER User Guide v 7.31

- **Source Media.** Lists media items available for use, or are already used in, the project. Each item will occur only once in this list. If used more than once, this is indicated in the Usage column.
- **Media Items.** Lists only the items that are actually used in the project (i.e., active). An item will appear in this list as many times as it is used in the project.
- **FX and FX Parameters.** Lists FX plug-ins used and FX parameters available in the project. The **FX Parameters** page is a “one stop shop” for managing any FX on any take or track within the project, for example to add envelopes or track controls, or assign control to an external device. These features are explained in the sections [Managing FX Parameters](#) and [Using FX parameter MIDI Learn](#).

You can drag media files (e.g., from REAPER's Media Explorer or from Windows Explorer) or FX (e.g., from the FX browser) into the Project Bay. These media items are added to the **Source Media** page. If the item is then used in the project, it will be added to the **Media Items** page. FX items are added to the FX bay.

Items within the Project Bay can be renamed, all instances of a media file or FX within the project can be selected: media/FX in the project can be replaced with any other media/FX from the Project Bay. You can also mute/solo media items and bypass/bypass FX.

Both Media pages and the FX page include a Retain column. When you drag media items or FX into the project bay, they are marked with a + in the retain column. This setting means that the entry will remain in the project bay even if there are no instances of that media item or FX in the project.

When you add media (by recording or inserting) to the project, they will appear as entries in the media items and source media bays, with the retain status unset. These entries will be automatically removed from the project bay if they are removed from the project itself. If you want the entries to remain in the project bay even after being removed from the project, you should enable retain for those entries in the source media bay.

FX entries in the project bay include a **Preset** column. If you change the selected in this column (from the right-click menu), the change is applied to all instances of that FX in the project with the previous preset. In addition, you can retain an FX entry with a specific preset, or multiple entries for the same FX with different presets, in the project bay.

The Project Bay includes the buttons **Actions** and **Options**. Clicking on either of these displays a menu. As an example, the **Options** menu is shown on the right. Most of these commands require little explanation.

Mirror selection in bay and project. This causes an item selected in the project to also be selected in the bay, and vice versa. You can also ensure that REAPER will **zoom to a selected item** when this option is enabled.

Use last selected item as source for “draw a copy” mouse action. This enables you to use pencil mode to create copies of the last selected item.

Space bar previews media allows use of the space bar to play the currently selected media or source media item. **Loop media preview** will allow any loop marked in the project to be applied. **Preview (source or media items) through selected track** allows you to play back the item with, for example, any FX in a particular track's FX chain, or any track envelopes, being applied.

There is an option to **Group similar FX into single** items and another to **Display the track index** (i.e. track number) **in the track** column. The **Filter** can be set to use name, path or comment.

Make sure the option **Clear bay when changing projects** is enabled if you wish to make each Project Bay project specific. Disable it if you want to carry over items in the current bay to the next project that you open or create. You also have the option to **Automatically retain media items when they are removed from project**. This ensures that retain status is automatically assigned when an item is removed from the project.

The **Dock project bay** and **Close window** commands are self-explanatory.

The commands on the **Actions** are shown right. They can be used with and applied to the items (media or FX) on whichever bay page is currently selected.

New project bay window opens a new project bay window. You can use up to eight project bays in a single

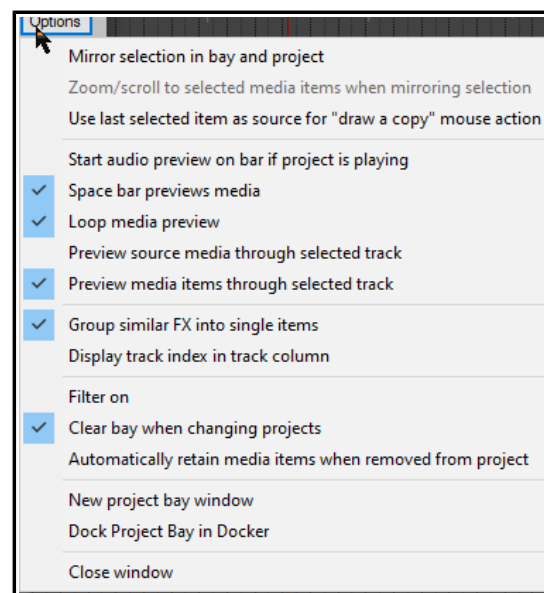

Managing The Overall Project

project. You can then use this (for example) to load a different saved project bay, whilst keeping the original bay open in the original window. This could be the case, for example, if you wish to sort/group media items into folders in more than one way.

Create new folder. Individual project bay entries can be dragged and dropped in or out of the folder (see example below, where two folders have been created, Instruments and Vox). Folders can be used for source media items (as shown below), media items (in project) or FX. Double click left of the folder name to collapse or expand the folder.

Force refresh forces a refresh of the project bay display.

Select all items causes all items in the current tab to be selected.

Retain all items causes all items in the current tab to be marked to be retained in the bay even when they are deleted from the project.

Remove all items from project will remove all items from the project, and **Remove all items that are not used in project** will remove from the media bay all items that are not used in the project.

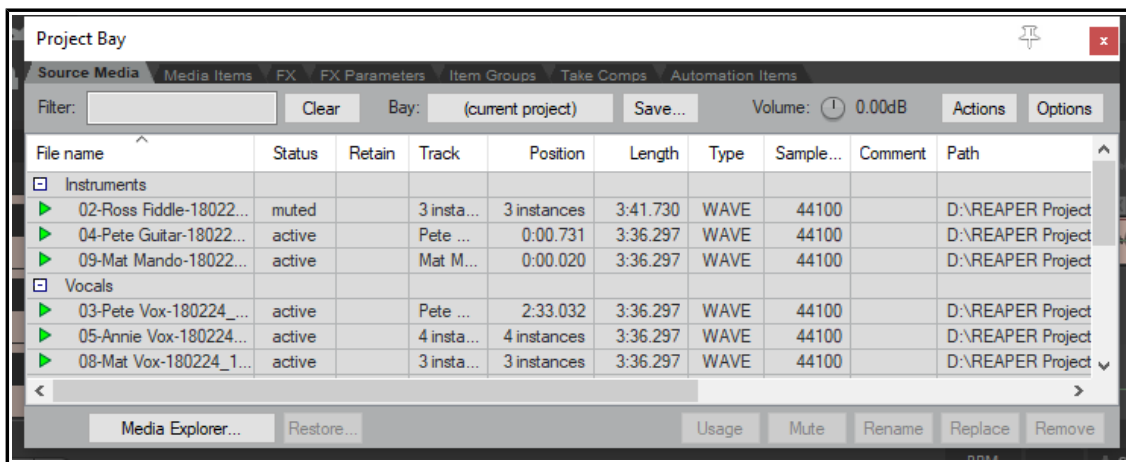
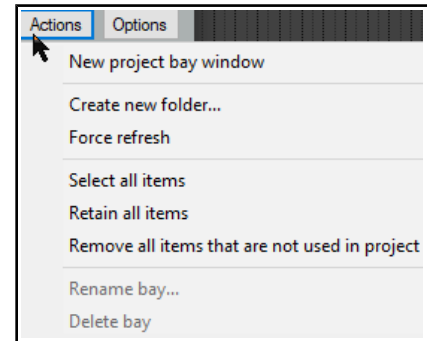

The **Media Explorer** button (lower left) can be used to open the [Media Explorer](#), from where media items can be dragged and dropped into the project bay (as source media) or into the project itself. Complete (untrimmed) items can also be dragged and dropped directly from Windows Explorer.

The rotary **Volume** control can be used to control the volume of any item being previewed when the option to preview thru selected track has been disabled.

The **Bay** field serves three basic functions. You can use it to create a new project bay, to replace the contents of the current bay with a previously saved one, or to merge the contents of a previously saved project bay into the current one.

The Source Media Bay and the Media Items Bay

The techniques for working with media items in both of these bays are very similar. The main differences are:

- Items dragged into the Bay are placed in the Source Media Bay only, until such time as they are actually added to the project. They are then automatically also listed in the Media Items bay.
- Only items which are active (and therefore included in the project) are shown in the Media Items Bay.
- Active items can be managed from either of these bays. Available items can only be managed from the Source Media bay.

In order to do this you do this
Change the column order	Click and drag column header left or right. You can do this with any of the five Project Bay tabs selected.
Hide/Show columns	Right click on any header, deselect/select from list. Note that the Fades column will show the length of fades in/out.

For a bound hard copy of the latest version of this User Guide (printed in B&W) go to LULU.com

Up and Running: A REAPER User Guide v 7.31

In order to do this you do this
Add an item to Source Media Bay	Drag and drop from Windows Explorer or REAPER's Media Explorer . You can drag an entire item or (if using Media Explorer) a time selection.
To preview an item	Select the item then press Space .
To add an item from Source Media or Media Items Bay to a project	<i>Either...</i> Drag and drop from Bay into the project arrange view window, <i>Or ...</i> Select track and position cursor in Arrange view. Right-click on item name in Bay and choose Insert into project from context menu. If not already active, its status will now be made Active.
To remove an item from within the project.	Select the item and use the Delete key, either from the arrange view window or within the Media Bay.
To remove an inactive item from Source Media Bay	Select item and press the Delete key, or right-click in item row in Retain column (to left of item name), then choose Remove from bay .
To remove all unused items from the Media bay	Right click on title bar, choose Remove all items that are not used in project from the context menu.
To remove the retain status of an active item	Select item in bay, right click in Retain column, choose Remove from bay if removed from project .
To remove all instances of an item from project	Right-click item in Retain column for the item, choose Remove from project .
To reassign retain status to an active item	Select item in Bay, right click in Retain column, choose Retain from menu.
To locate a Media Items Bay item or Source Media Bay item in the project	Click on the item in the list then on the Usage button. Click on any item in that list in order to go to and select that item.
To mute an item in project	Right-click on item, choose Mute from the context menu (to toggle).
To rename any media item	Select item in the Bay: click Rename button or use the context menu.
To add comment to an item	Double click in the comments column of the item row.
To filter the media item list <i>See also section Using Search Filters for advanced options.</i>	Type a text string in the Filter box (e.g. cox to see only media items with cox in their name) then click on the Refresh button. To clear a filter, click on Clear Filter button.
To replace a Source Media or Media Items item with another item	Select item name in Source Media or Media Items list. Right-click and choose Replace in project . Then select from flyout menu, e.g. All instances or any single instance: choose the replacement item. The media format (e.g. MP3, WAV) need not be the same for both items.
To save an item set list from the Bay (for possible use in other projects)	Select item, click on Save : choose either Save selected items to a new project bay , or Save all items as a new project bay . You will be prompted for a new .Rea Bay file name. You also have the option to Save and merge selected items to an existing project bay file, in which case you will need to select the required file from the list.
To load a previously saved item set list.	Click on the Bay button, choose a .Rea Bay file from the list. You may Load and merge it with the current one, or replace the current one.
To sort Media Items list.	Click on any column header to sort. Click again to reverse sort order.
Other Media Items page columns	Other information displayed in the Media Items tab are the number of Takes , Active take details , and Fade in/Fade out details.

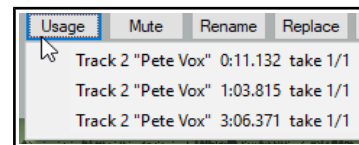

Managing The Overall Project

The FX Bay and FX Parameter Bay

Many commands here are the same as the Media Bay – e.g. set retain status on/off, apply/clear filters, using folders, and removing items from the bay are handled in the same way. Shown here, two folders are being used to organise the FX. Aspects more specific to the FX Bay itself are:

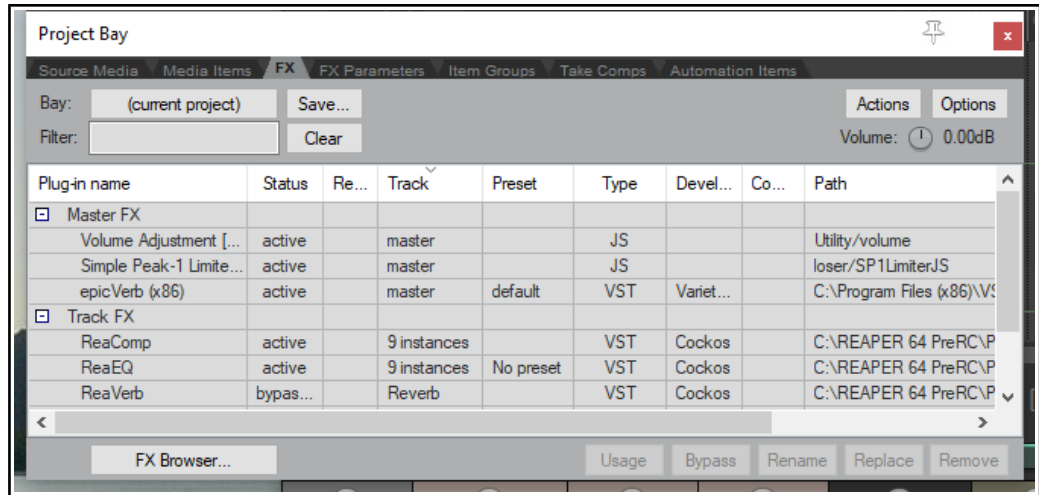

In order to do this you do this
Show FX performance stats	Right click on any column header, select Performance .
Sort by any column header	Click column header (twice for reverse sort).
Add FX from FX Bay to track or media item in project	<i>Either...</i> Select track or media item in Arrange view, right-click on plug-in name in FX Bay, choose Insert into project <i>Or...</i> Drag and drop plug-in from FX Bay to track panel or media item.
Open FX browser window	Click on the FX Browser button.
Add FX to the FX Bay	Drag and drop from FX Browser.
Mirror bay/project FX	Enable Mirror selection in bay/project on Options menu.
Locate and open FX window for any FX instance	Right click on track name in the Track column then click on the required instance (or select plug-in and click the Usage button). <div data-bbox="1161 1144 1445 1249" style="border: 1px solid black; padding: 2px; margin-top: 5px;"> <div style="display: flex; justify-content: space-between; border-bottom: 1px solid black; padding-bottom: 2px;"> Usage Bypass Rename R </div> <div style="padding: 2px;"> <p>Track 2 "Gtr Body" FX 2/3</p> <p>Track 3 "Gtr Neck" FX 2/3</p> </div> </div>
Toggle any FX to bypass or offline	Select the FX then choose Bypass or Offline from the right-click menu, <i>or</i> use the Bypass button (Shift-click for Offline).
Assign a preset to an FX **	Right-click in the Preset column for the FX and select from the menu.
Manage any FX parameter	Right-click on FX name, choose FX parameters then FX parameters list , then select feature (e.g. Show in track controls or track envelope), then select parameter from list.
Toggle auto-bypass on silence for FX instance	Right-click on plug-in name, select Force auto-bypass on silence from context menu. The silence threshold is set in project settings .
Change FX instance preset	Right-click in the Preset column for the FX and select from the menu.
Replace one FX with another project bay FX	Right-click on FX name, choose Replace in project then select from the flyout menu of FX. You can replace all instances or a single instance.
Locate FX on hard drive	This information is displayed in the Path column.

**** Note:** The same FX name will occur more than once in the plug-in name list if there are any instances where that FX has been assigned a preset..

Next to the **FX** tab is the [FX Parameters](#) tab, used for managing FX parameter features such as envelopes, learn mode and parameter modulation. Chapter 19 deals with [parameter modulation](#).

12.7 The Track Manager

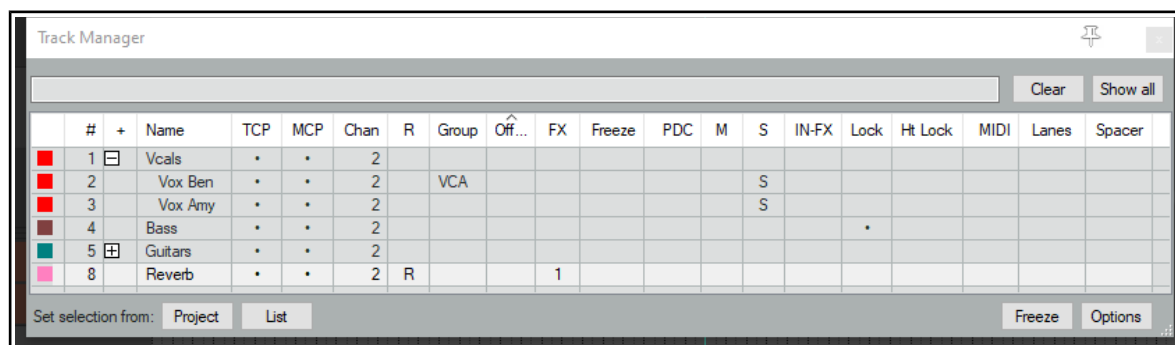

The **Track Manager (View, Track Manager)** gives you overview control of your tracks. It shows a grid similar to a spreadsheet or table. If the grid is empty, click on the **Show All** button (above right) to display the project's tracks.

The **Options** button menu includes **Mirror track selection**. (so that a track selection made in either the Track Manager or the TCP is also applied in the other) and, optionally, to **Scroll to selected track** in TCP and mixer.

There is an option **When changing visibility or grouping for folder tracks, also change tracks in those folders**.

Folder/child tracks hierarchies are retained within the track manager. The option to **Indent tracks in folders** can be disabled from the **Options** menu. Other **Options** button menu items are explained in the table below, which also summarises the options within the track manager window.

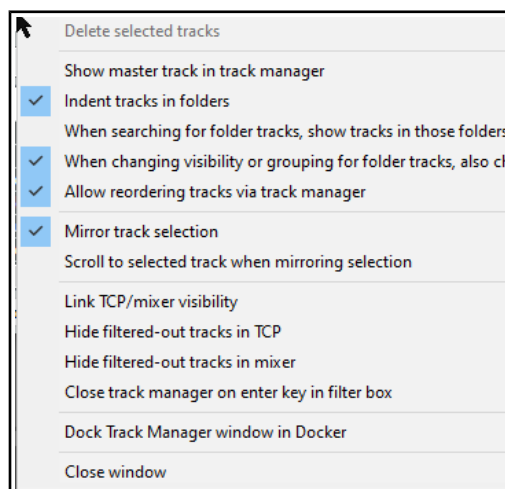

To do this you do this
Change column order	Click and drag column header left or right.
Hide/Show columns	Right click on any header, deselect/select from list.
Expand/collapse folders	Click on the +/- symbol in the column headed +.
Adjust column width	Click and drag left or right on boundaries between column headers,
Filter the track list by name <i>See also the section Using Search Filters for advanced options.</i>	Type text in filter box: e.g. "co" to list only those tracks whose name includes co. Supports use of NOT and OR filters: e.g. "bass OR guit" will find all tracks with either bass or guit as part of their track name. Options menu commands include Hide filtered-out tracks in TCP and/or Hide filtered-out tracks in mixer . The Clear button removes the filter. There are options in this menu When searching for folder tracks make sure child tracks in those folders are shown and to Close track manager on enter key in filter box from the Options menu.
Change TCP track order in track manager	Drag and drop tracks up or down. This can be disabled by disabling Allow reordering tracks via track manager from the context menu.
Delete track	Select track row and press Delete . You will be prompted to confirm this.
Show/hide Master	Toggle Show master track in track manager in Options button menu.
Show/hide tracks in TCP/MCP	Click in track row in TCP/MCP columns. You can use the toggle option (on the Options button) to Link TCP/Mixer visibility to synchronize track display. Supports " Swipe " (see last row of table).

Managing The Overall Project

To do this you do this
Set/change track color	Click on square in the first column, then Set color or Set to random color .
Open track grouping dialog for any track	Double-click that track's cell in the Group column.
Scroll track into view	Double-click on track number in # column.
Open/show track FX chain	The FX column shows the number of FX in each track's FX chain. Double-click on that cell to open the FX chain for that track.
Add FX to track or open an FX window	Right click over the track's FX cell and use context menu, <i>or</i> Drag and drop from the Add FX window to the track in the track manager.
Open/show track Input FX chain	The IN-F column shows the number of FX in each track's Input FX chain. Double-click on that cell to open the input FX chain for that track.
Monitor plug-in delay compensation	Any plug-in delay compensation used by a track's FX will be indicated (in ms) in the track's PDC cell. Clicking on this cell toggles track FX bypass.
Open a track's routing window	Double-click in the Chan (channels) column for that track.
Arm/unarm tracks for recording	Click in the R column for any track(s) to arm for recording. The letter R will be shown for armed tracks. Click again to unarm. Supports " Swipe " (below). Right click on any cell in this column to display record menu for that track.
Mute/unmute tracks	Click in the M column to toggle mute status. All the modifier keys used in the TCP can be used here – e.g. Ctrl Mute to unmute all. Right-click for TCP mute context menu – see Chapter 5. Also supports " Swipe " (see below).
Solo/unsolo tracks	Click in the S column to toggle solo status. All the modifier keys used in the TCP can be used here – e.g. Ctrl Alt Solo to solo exclusive. Right-click for TCP solo context menu – see Chapter 5. Also supports " Swipe " (see below).
Lock/unlock track controls	Click in the Lock column to toggle lock status. Locked tracks display a + sign. Supports " Swipe " (see last row of table).
Lock track height	Click in Ht Lock column to toggle.
Manage MIDI items	Double-click a track's MIDI cell to open track MIDI items in new MIDI Editor. If item is already open, double-click to close. Right-click in cell for menu of options: Open in new MIDI editor , Open in existing MIDI editor , Open in existing MIDI editor (clear editor first) or Remove from MIDI editor . The third of these options removes from the MIDI editor any tracks/items already open before opening this one.
Free Item Positioning on/off toggle	Click in the Lanes column to toggle on/off Free Item Positioning. FIPM on shows a + sign. Supports " Swipe " (see last row of table).
Insert/remove virtual spacer above track	Click in the Spacer column for that track.
Freeze/unfreeze tracks	Select track(s) in Track Manager window, then choose whichever action you wish from the Freeze button menu. See also Chapter 6 .
Sort Track Manager list	Click on any column header. Click again to reverse sort order.
Manage track groups	The track manager will respect grouped track parameters (Chapter 5). As with the track grouping matrix , you can use Shift to temporarily over-ride these.
Swipe to toggle several adjacent tracks	For example, to mute or solo or lock several adjacent tracks, click and drag/sweep down the track list in the appropriate column.

Up and Running: A REAPER User Guide v 7.31

In the example shown above this table, the **Guitars** folder is collapsed so that its child tracks (tracks 6 and 7) are not displayed. It has two FX and four channels. The **Bass** track is locked. All tracks are accessible in the TCP and MCP (although to view tracks 6 and 7 you would need to expand the folder). Both the **Vox Ben** and **Vox Amy** tracks are soloed. They are also FIPM enabled and are grouped as group 1. The **Reverb** track has one FX.

Tip: You can use the **Screensets** window to save different sets of Track Manager settings as Track Views, any of which can be recalled in an instant. Screen sets are explained later in this chapter.

12.8 Track View Screen Sets

Screen Sets enable you to save several different views of your project, so that you can easily select and recall them when editing or arranging. There are two types of Screen Set – Track Views and Windows.

Track Views are created and saved on a per project basis – the screen set data is stored in the project's .RPP file and can be recalled only when you are working with that project file. Using track view screen sets can be especially useful when you are editing or in some other way working closely with media items.

Windows screen sets are global and are stored in the Application Data screensets.ini file. They can be recalled from, and applied to, any project file.

The procedure for creating track views is:

- Use the **View, Screensets/Layouts** command to show the Screen Sets window (the default keyboard shortcut is **Ctrl E**). The Screen Sets window may be docked (or undocked), or pinned to stay on top.
- Adjust your track layouts to suit.
- Select a number from the Track views page of the Screen Sets window.
- Click on **Save** and name the set.

You can create up to 10 track view screen sets per project. To recall a view, double click on its name.

You can also assign keyboard shortcuts to individual screen sets. By default, **Shift F4** to **Shift F6** are used to save your first three track views, and **F4** to **F6** are assigned to load each of these first three track views.

If you want to modify these, or assign shortcuts to other track views, then you should click on the **Edit shortcuts** button in the Screensets window. This opens the **Action List Editor**. For instructions on how to use the **Action List Editor**, see Chapter 15.

Notice that there is also an option available to Auto save **when switching screen sets**. If enabled, this ensures when switching from one screen set to another that any changes made to the layout of the first of these screen sets will be saved. The **Edit fields...** button can be used to "tweak" this, so that only certain aspects of your changes are automatically saved.

Example

1. Open the file **All Through The Night.RPP** and save it as **All Through The Night TRACK VIEWGRAPH**.
2. Adjust the track height of your **Vox** track as shown here (above).
3. Choose the **View, Screensets/Layouts** command and display the Track Views page, click on **1**, then **Save** to open the **Save Track View** dialog (below).
4. Type: **Vox View** but do not yet press **Enter**.

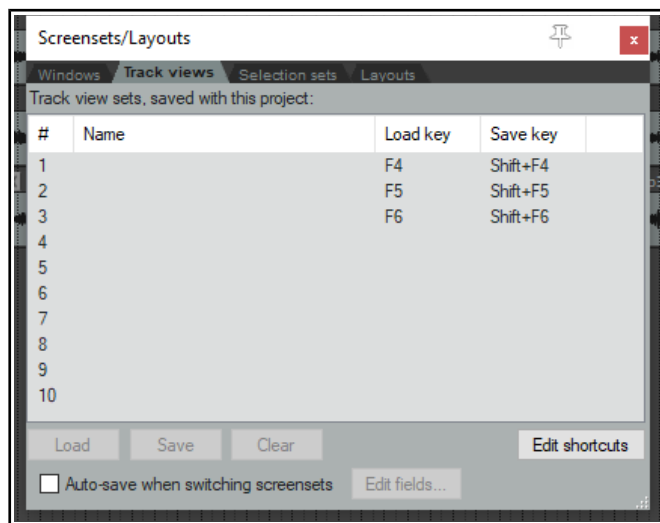

Managing The Overall Project

- Take a look at the five options that are available. We'll examine these shortly. For this exercise, make sure that only **Track control panel status** is selected.
- Click on **Save**.
- Now adjust the track heights so that all tracks are minimized except the two guitar tracks. Make these two tracks high enough to show all track controls.
- In the Track views window, click on **2**.
- Click on **Save** to open the **Save Track View** window.
- Again make sure that only **Track control panel status** is enabled and type **Guitars View**. Press **Enter**.
- To switch between these track layouts, double-click on their names in the Screen Sets window.

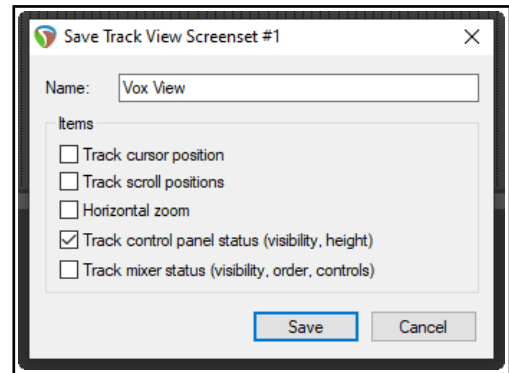

This simple example has introduced you to screen sets and how to use them. Because we selected only the option **Track control panel status** the project track layout was the only information saved with this screen set. Notice the five options that you may choose to include in or exclude from a track view:

Track Cursor Position	Track Control Panel Status	Horizontal Zoom
Track Scroll Position	Track Mixer Status	

To remove any screen set that you do not wish to keep, simply select it and click on the **Clear** button.

Track Mixer Status

Notice that one of the options that you have when saving track view screen sets is **Track Mixer** status. This option can be used to save any **Track Manager** settings regarding which tracks are and are not displayed in the Mixer at any time. Switching between different track views would then automatically select different selections of tracks to be shown in the Mixer.

Do not confuse this with the option **Mixer flags** in **Windows** screen sets, which allows you to select not which tracks but which mixer elements and options (FX inserts, sends, multiple rows, etc.) are applied.

Note: As you adjust track panel height and/or width, the display area for track controls will become smaller or larger. Some may disappear or reappear. An example is shown here.



12.9 Windows Screensets

At different stages of your project you are likely to need to use different combinations of views. For example, you might not need to see the mixer when recording but you might need the media explorer. Later you may need the mixer and, perhaps, the track manager but not the media explorer. This is where Windows screen sets can be useful.

Unlike track view Screen Sets, Windows Screen Sets are not project specific, but can be applied to any project. They are stored in the Application Data folder in a file called screensets.ini. After opening

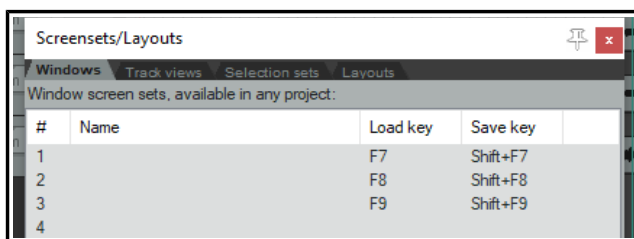

the Screensets/Layouts view (**Ctrl E**), to create Windows screen sets you should do this:

- Decide which windows and views you want displayed, and arrange them on screen.
- In the Screen Sets window, select the **Windows** tab, select a number, then click on **Save**. Type a name, then select your options as you require (see below). Click the **Save** button.
- To recall and open any screen set, double-click on its name, or select it and click on the **Load** button.
- To change a screen set, open it, make the changes, then save it.
- To remove a screen set, select it and click on the **Clear** button.
- To rename a screen set, select it, click **Clear**, then **Save**, type new name, click **Save**.

Up and Running: A REAPER User Guide v 7.31

You can also use keyboard shortcuts with Windows screen sets. By default, **Shift F7** to **Shift F9** are assigned to saving Windows screen sets 1 to 3, and **F7** to **F9** to loading them. These assignments can be changed in the [Actions List Editor](#) (see Chapter 15), accessed directly from the Screensets window by clicking **Edit shortcuts**.

The options that you may choose to include in or exclude from any screen set are:

Main Window Position	Mixer Flags
Tool Window Positions	Layouts
Docker Selected Tab	Last focus

Some of these are self-explanatory. In addition, note that:

The **tool window position** option will cause the position of those windows which are defined by Windows as tool items (such as VST FX and the MIDI Editor) to be saved and recalled with the screen set. For any particular project, however, this will only be applied if that particular window exists in that project. This option is useful, for example, if you use a set of standard plug-ins in the Master and you want to easily be able to open and close all these FX windows when working with any project.

Enabling **docker selected tab** will ensure that whichever window in the docker is visible when the screen shot is saved will be visible when it is recalled.

The **mixer flags** option, if enabled, will save your various Mixer menu options (FX inserts, sends, folders, top level tracks, position of master, etc.) with the screen set. These options are discussed in detail in Chapter 11.

We encountered **layouts** in Chapter 11, in the context of the Mixer. You'll find more information about Layouts later in this chapter. Enabling this option will ensure that your layouts are saved with the screen set.

The **last focus** option can be selected to ensure that a particular view automatically is given focus whenever the Screen Set is loaded.

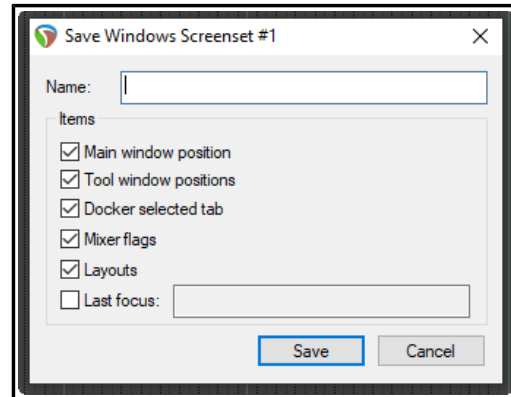

12.10 Auto Saving Screen Sets

You have the option to automatically save changes to your Track Views or Windows screen set layouts. To do this, simply ensure that the **Auto-save when switching screen sets** option is selected (see below). This can be used to ensure for example, that if you change the selected tab to be displayed in the docker before switching to a different Windows screen set, when you return to the first screen set, REAPER will have remembered which docker tab was last selected.

If using auto-save, consider using the **Edit fields...** button to decide which elements for which you want changes automatically saved (see right).

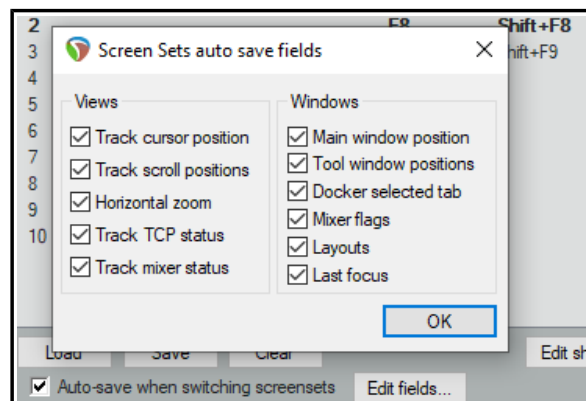

The available options are all items that were included in your options when you created your screen sets.

12.11 Creating a Text Track

You can create a text track that can be used to display lyrics and/or any relevant song notes (see right).

To do this, follow this sequence:

- Add a track and, with the track selected, make a time selection covering the length of the song.
- Choose the **Insert, Empty item** command.
- Double-click on the item to open it. Type your text, then click **OK**.

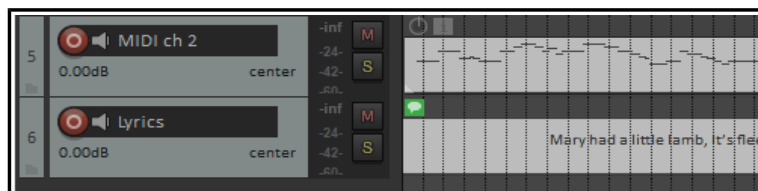

Managing The Overall Project

12.12 Item Selection Sets

By using item selection sets, you are able to create many different selections of items within a project file and select all of the items in any set simply by selecting that set name. The procedure is as follows:

- Use the command **View, Screensets/Layouts** to display the Screensets window.
- Select the **Selection sets** tab.
- Within your project, select all of the items to be included in the group. These can be on a single track or across any number of tracks.
- Select a set number, then click on **Save**.
- Give the group a name and press **Enter**.

At any time you can now recall that group by double-clicking on its name, or by selecting the name and clicking on **Load**.

In the example shown here, two selection sets have been created, one for Vox Verses and one for Vox Choruses. Simply by double-clicking on the required set name, we can select all of the items in either set.

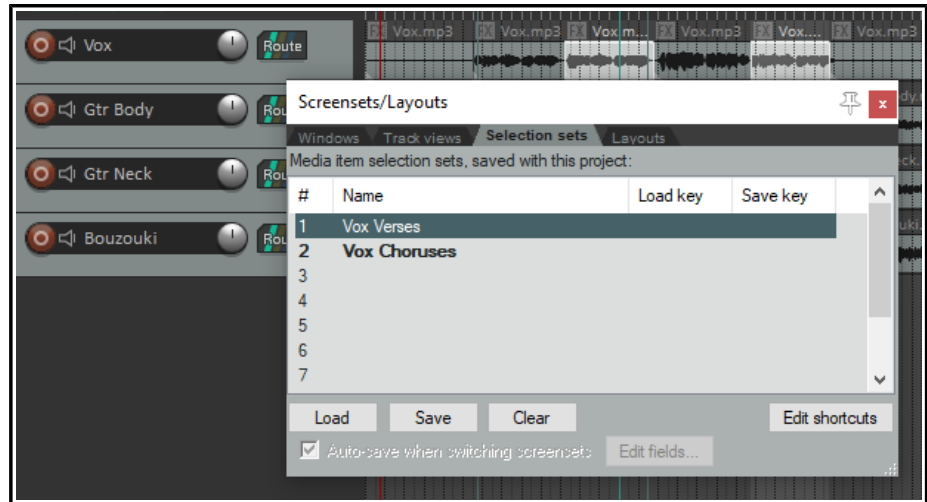

12.13 Track, Mixer, Transport and Envelope Layouts

Layouts in general, and [mixer layouts in particular](#), were discussed in Chapter 11. Layouts are created, stored and retrieved with individual themes. From the **Layouts** tab of the Screensets/Layouts window you can select any theme from the drop down theme list. Layouts are designed and created for use with individual themes. Therefore, the choice of layouts available to you will be largely dependant on which theme you are using. Themes can be downloaded from stash.reaper.fm.

Layouts associated with your chosen theme will be available to you from the various drop-down lists in this window, such as track panel layouts and mixer panel layouts. For earlier themes that do not include any layouts, a number of standard layouts are available.

Shown right is an example, in this case double-clicking to display the Mixer Panel drop down list and to select a mixer layout. This is an example only – the exact range of choices available to you may not be exactly the same as shown here. When one of these drop down lists is displayed you can hover your mouse over any item to see how it looks, in this example in the mixer.

Here is a summary list of the main layout elements available:

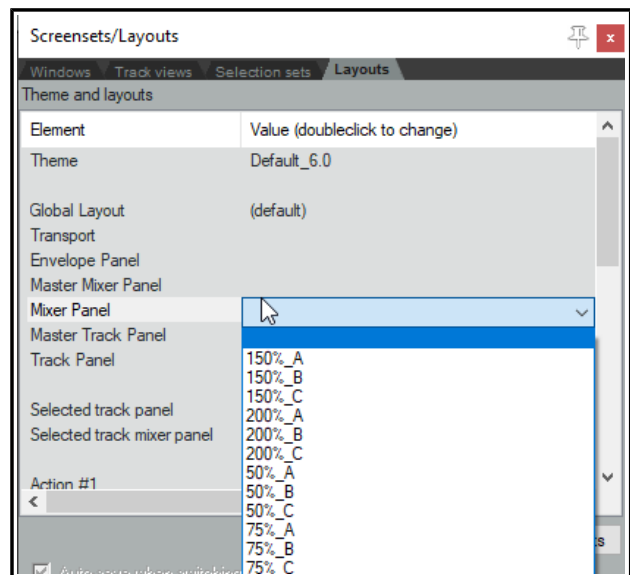

Global Layout	Selects theme defaults for all layout elements.
Transport	Selects layout for the Transport bar .
Envelope Panel	Selects a layout for track envelope panels . See Chapter 18.
Master Mixer Panel	Selects a layout for the Master in the Mixer panel .
Mixer Panel	Selects a layout for all tracks and folders in the Mixer panel .
Master Track Panel	Selects a layout for the Master in the Track control panel.
Track Panel	Selects a layout for all tracks and folders in the Track Control panel.
Selected track panel	Selects a layout for selected tracks in the Track Control panel.
Selected track mixer panel	Selects a layout for selected tracks in the Mixer panel.



Shown here is an example of one rather different track panel layout that you might choose – Standard Media. Amongst other things, it uses horizontal faders (rather than rotaries) for volume control.

You do not need to open the Layouts window to select layouts for a project. You can also use the **Options, Layouts** command from the main menu or the **Track layout** command from the TCP or MCP context menu.

Assigning Actions to Layouts

You can scroll down the Layouts screen to assign (to shortcut keys and/or to custom toolbars) up to 20 actions to recall any layout. Click on the **Edit shortcuts** button to assign shortcuts to any of the **Layout** actions.

12.14 Moving Track Panel Position

You can move the entire track panel to the right hand side of Arrange View if you wish. Right click in the empty track panel area (below the last track) and choose the toggle command **Show TCP on right side of arrange**.

12.15 Play/Stop Cursor Options

By default, when you use the spacebar to start/stop playback, then on stopping the play cursor will return to join the edit cursor at the position it was at when playback started. However, you also have an option to instead leave the play cursor at its stop position when playback stops, and to move the edit cursor forward to meet it.

Open the **Actions List** and find the action **Transport: Play/stop (move edit cursor to stop)**. This can be assigned to a combination of your choice (e.g. **Shift Space**).

12.16 SWS Extensions

REAPER's screen sets are powerful, but the optional free **SWS Extensions** package adds even more functionality. For example, it enables you to save and recall different entire mixes within a single project.

Also, as you get to know REAPER better you will find that there are a number of editing and related actions that you will want to use frequently. This might include, for example, actions as diverse as lining up a number of media items with the edit cursor, or setting the volume of an entire selection of media items in one action. You will find that many of these actions – and more - are available by downloading and installing the **SWS Extensions Pack**. To do this, you simply follow this sequence:

1. Go to <https://www.sws-extension.org/>
2. Follow the instructions to download the correct version for your operating system.
3. After downloading, run the install program, then start REAPER in the usual way.

The contents of this extension pack include not only hundreds of useful actions for editing and more but also whole modules which bring extra functionality to REAPER, including improved marker management.

12.17 Using FX Parameter MIDI Learn

In Chapters 2 and 6 we looked at some uses for the **Param** button in REAPER's FX plug-in windows. In chapters 16 and 17 you'll see how this can also be used to create **automation envelopes** and for **parameter modulation**. In this section, we will explain how to assign control of an FX parameter to an external device.

When you touch the control in the FX window with your mouse and then click on the **Param** button, then choose **Learn** the Learn window is displayed (see below). Twiddling the control (such as fader or rotary) on your **control surface** device will cause information to be displayed in the **Command** window about the channel and CC assignment for this control. This information is picked up from the control surface.

Managing The Overall Project

Choice of CC mode (absolute or relative) will depend on the parameter being assigned and your own control device. In many cases, absolute mode with soft takeover will be appropriate, but you may need to experiment.

Soft takeover: if enabled, the learned parameter will not be changed by moving a MIDI knob or fader until the MIDI knob/fader equals the value on the screen.

For example, if the current value of a parameter is (say) 100 and the controlling hardware slider is (say) 30, then with soft takeover enabled moving the fader will not cause any change to the parameter value until the value of the fader itself nears 100. If the fader is then moved to (say) 120, then the parameter value will also be moved to 120.

The options to **Enable only when effect configuration is focused/visible** can be used to ensure that this [control surface](#) assignment will only be used when that plug-in has focus and/or is visible. This enables you to assign the same control surface fader to any number of different functions with different plug-ins. For example, the same fader used to control EQ gain in one plug-in could also be used to control the threshold setting on a compressor.

When one or more parameters in a plug-in has been assigned to a control surface, you will see an extra command on the **Param** menu – **Default controller mappings**.

This leads to a flyout menu with three options – **Use default**, **Save as default**, and **Clear default**. You can thus use this menu to save these settings as the default for this plug-in, so that these controls will be automatically made available whenever that plug-in is loaded into other tracks.

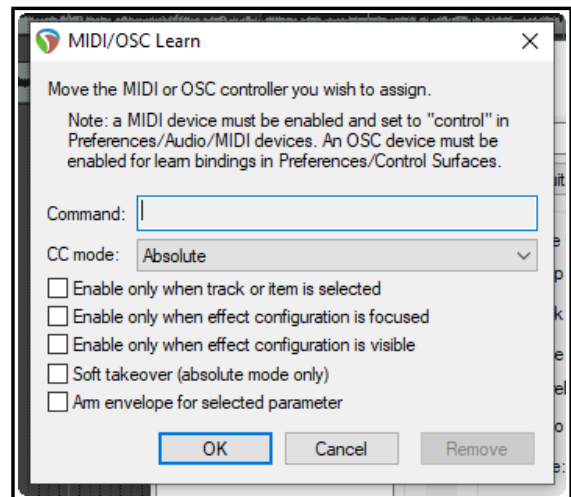

12.18 Track Templates Revisited

Back in Chapter 3 when discussing recording, we mentioned [track templates](#) and how useful they can be. Now that you have discovered a lot more about REAPER, it's worth revisiting this topic. Track templates can be your best friend when you are setting up your projects.

A track template can be made up of any track or any selection of tracks. For example, you might have a folder called Drums. This might contain a series of child tracks – Kick, Snare, Toms, Hi hat, etc. – all of which have their own track FX with their own settings, and with volume and pan faders set at their own levels. You could save the entire folder (parent) with its child tracks and all their settings into a single track template called Drum Kit.

Items that get included in track templates include track name, track control settings, track properties (color, icon, etc.), track FX (together with their parameter settings), track controls, FX alias names and FX parameter alias names, parameter modulation, FX parameters, sends and receives, and more.

To save a track (or selection of tracks) as a track template, choose **Track, Save tracks as track template** from the main menu. To insert tracks from a track template into a project, choose **Insert track from template** then **Open template** from the same menu.

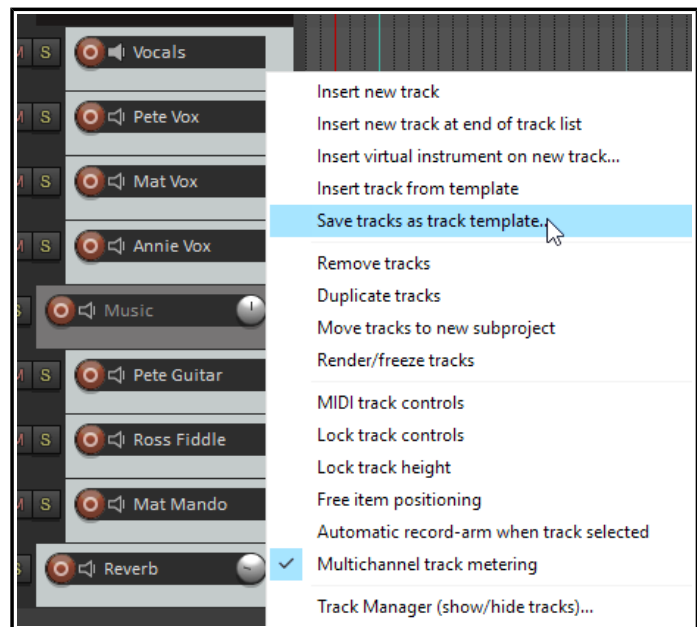

12.19 Track Control Panel and Menu Bar Help

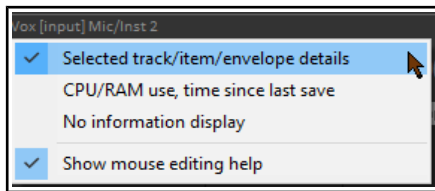

A selection of useful information can be displayed below the control panel and at the end of the main menu bar. Right click just below the track control panel and select from these options:

- Selected track/item/envelope details**
- CPU/RAM usage, Time since last save**
- No information display**
- Show mouse editing help**

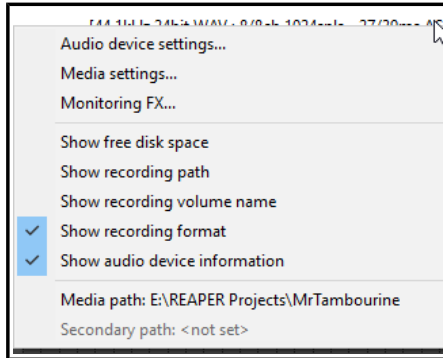

The first three of these options are mutually exclusive: that is you can select only one of them. In the case of the menu bar (right hand end), you can select from the following options:

- Show free disk space**
- Show recording path**
- Show recording volume name**
- Show recording format**
- Show audio device information**

This menu also gives you access to the **Audio Device** page of your preferences, the **Media Settings** page of your project settings, and the **Monitoring FX** window.

12.20 Associating Rendered WAV Files with Source Project Files

When using the **File, Render** command to [render a project](#) (or part of a project) to .WAV file(s), there is an option to **Include project file name in BWF data**. Rendering is explained in detail in Chapter 21. If this option is enabled, the RPP project name will be embedded in the rendered file(s). This ensures that this RPP file will remain associated with the rendered WAV file(s).

If any file rendered with this option enabled is subsequently inserted into another project, then the command **Open associated project in tab: xxx.RPP** (where "xxx" represents the associated project file name) will appear under **Open items in editor** on the media item context menu.

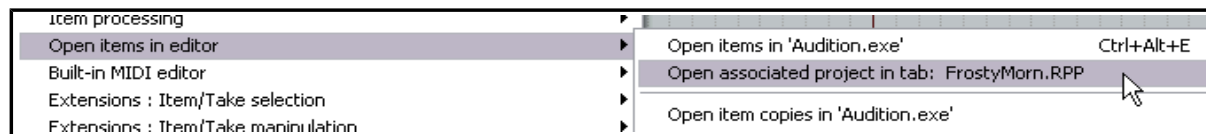

12.21 Multiple Project Backup Versions

The [Project page](#) of REAPER's Preferences includes an option when saving to create multiple rpp-bak backup files. To do this, enable the option **Keep multiple versions**, with or without (as you wish) their own undo histories. If enabled, using **File, Save project as...** to save a project (over writing the previous file) will cause a new time and date stamped backup version to be created.

Opening the .RPP file will always open the most recently saved version. However, opening the **RPP-BAK** file will cause a **Choose version from backup file** dialog to be displayed. Here you can select which version you would like to load. With multiple project tabs you are able to have multiple versions open at the same time. This can be used to create a new project tab into which it will open the associated RPP file.

12.22 Using Multiple Dockers

In Chapter 2 you were introduced to working with [REAPER's docker](#) as an aid to navigating your way thru REAPER's various views and windows. In fact you are not restricted to just one docker: you can create up to 16 dockers if you wish. In the example shown here, we have two dockers attached to the bottom of the main window and a floating docker. The first docker (bottom left) contains tabs for displaying the Routing matrix, the Mixer, and the Media Explorer. The second is used to display at any time the Screensets window, the Track Manager or the Undo History. The floating window is a third docker, and this contains tabs for displaying the FX chains for four of the tracks in the current project. This is, of course, only an example.

Managing The Overall Project

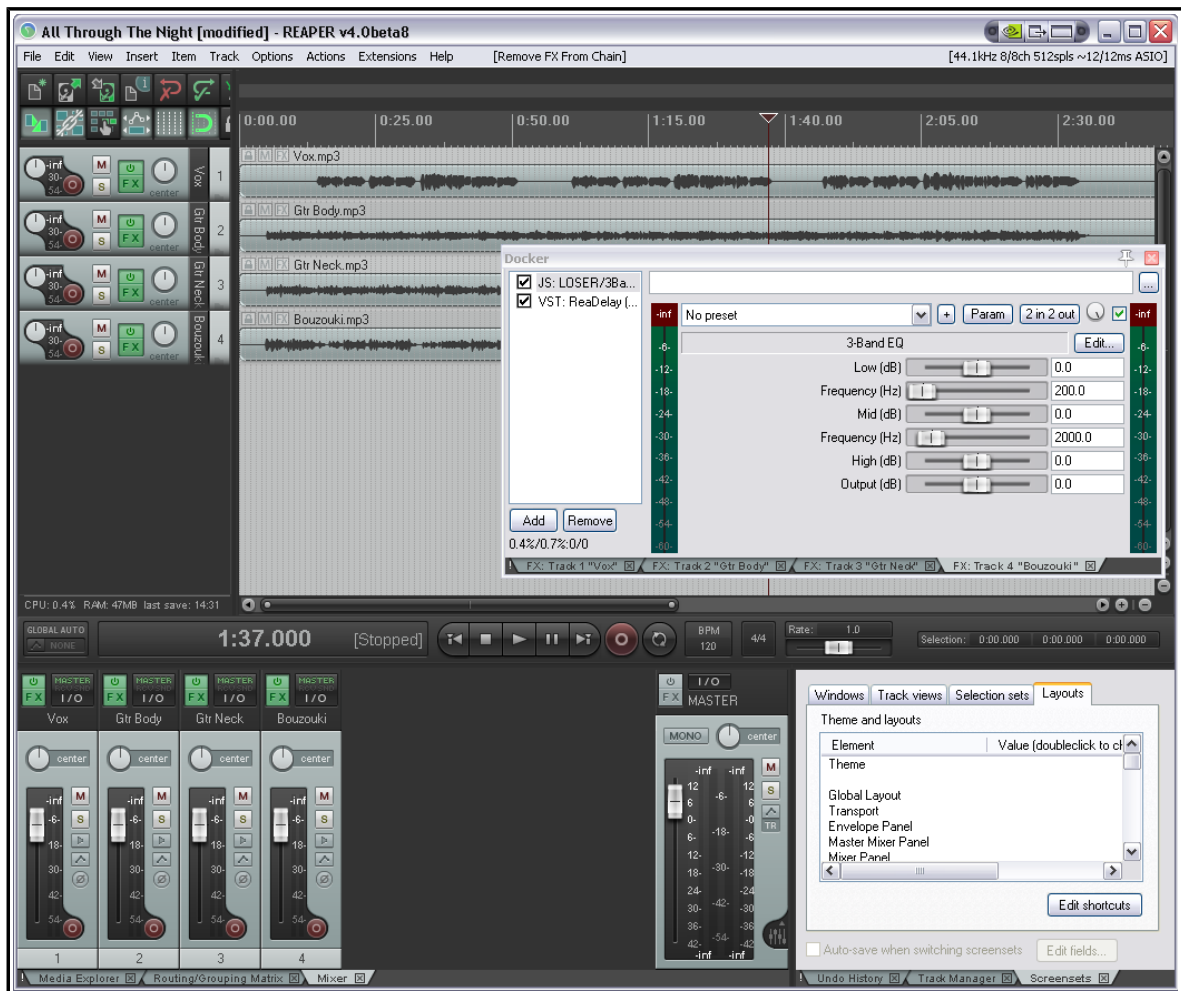

These instructions assume that you are already familiar with the basic techniques for [docking and undocking](#) windows, and so on, as explained in Chapter 2. You can attach any docker to the main window in any of the four positions. You can also choose the same position for more than one docker (for example, you might wish to attach two dockers to the right).

To do this ...	You need to do this ...
<p>Attach a docker to the main window</p>	<p>Click on the ! to display the menu, then choose Attach docker to main window, then select a position (bottom, lefts, top or right).</p> <p>Several dockers can be attached to any position. Click and drag on the boundary between two dockers docked in the same position to adjust the position of the boundary between them (and therefore the relative size of the two dockers).</p> <p>This menu also allows change to a docker position, e.g. from top to left.</p>
<p>Dock a window</p>	<p>Right-click on the window's title bar and choose the command Dock ... in Docker.</p>

- Attach Docker to main window
- Attached docker position: bottom
- Attached docker position: left
- Attached docker position: top
- Attached docker position: right
- Compact docker when small and single tab
- Show tab close buttons
- Set opacity
- Hide dock
- Close all windows in dock

For a bound hard copy of the latest version of this User Guide (printed in B&W) go to LULU.com

To do this ...	You need to do this ...
Create a new docker	Drag and drop any tab from an existing docker into the arrange view area.
Move a window from one docker to another	Drag and drop the tab from its present docker to its new one.
Reorder tabs in any docker	Drag and drop tabs left or right.
Close a docked tab	Alt Click on tab, or click on tab x button.

12.23 Saving New Project Versions

REAPER's action list includes an action **File: Save new version of project (automatically increment project name)** which by default is assigned to the keyboard shortcut **Ctrl Alt Shift S**. This causes a new .RPP file to be created when you save a project. Thus, if, for example, you have a file open called WinterBlues.RPP then running this action would cause this project in its current state to be saved as WinterBlues_1.RPP. Running the action again would save it as WinterBlues_2.RPP, and so on.

12.24 Projects and Subprojects

A powerful feature of REAPER is the ability to build a master project that uses any number of subprojects, rather than having to store all your individual tracks, folders and media items within a single project file. This has many potential applications but is likely to be especially useful for projects which require a very large number of tracks or for sound design projects where you might wish to use subprojects to build a single overall audio item. The more the subprojects contain multiple media items which need intricate editing, or make use of features such as automation, parameter modulation and FX, the greater the potential benefits (in terms of project management) of using subprojects. Another example might be for a single subproject (or proxy) to be used in multiple projects (for example, advertisements), so that when it is updated all of the "master" projects are automatically updated.

Before working with subprojects, however, you should first develop a solid knowledge and understanding of REAPER's essential project building features, such as (but not confined to) audio and MIDI recording, the media explorer, editing media items, track and item FX, and automation. In principle, subprojects are not too difficult to understand. In overview, the *basic* steps involved in using it are as follows:

1. Create a new project file in the normal way (**Ctrl N**), and save it. In doing this, it is advisable to select the option to create a subdirectory for the project. Consider also whether you wish to use one of the options to copy or move all media into the project directory.
2. Create (either by recording or importing, or some combination of both) one or more tracks for this project, such as some foundation tracks or a guide track. You do not have to do this before adding any subprojects, but it can often make sense to do so.
3. Create a track to "hold" your subproject. The reason for this should become clear shortly. Name this track: e.g., if it is for drums, call it Drums, or for strings, call it Strings, or for foley or sound effects call it Foley or SFX, and so on.
4. Select this track and choose the command **Insert, New subproject**. If you wish, you can set the initial length of the subproject by defining a time selection before doing this. When prompted, accept the default name or make up a name (e.g. DrumsSub, StringsSub, etc.) and click on **Save**.
5. A short media item will be inserted at the play cursor position. This is (or represents) the subproject.
6. Double-click on this item to open the sub-project in a new tab. Two markers are automatically created, (=START and =END) at the start and end of the subproject. They define the rendered portion of the subproject, and can be moved or deleted at any time.
7. Build your subproject by recording or importing media as required. Various options that control playback behavior when working with multiple projects open are available on the project tab context menu. We'll get round to explaining these shortly.
8. When finished, press **Ctrl S** to save the subproject. The media items will be rendered to a single file which will appear as a single media item on its own track in the main project.

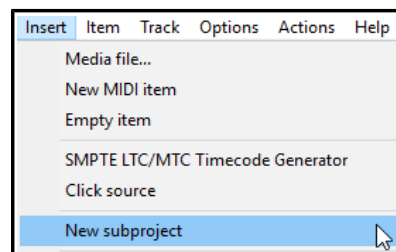

Managing The Overall Project

9. Display the main project (select its project tab). You may need to extend the length of the media item on the sub project track to display its contents. You may now close the subproject file if you wish. It can be re-opened by double-clicking on the media item in the main project file. With large projects (e.g. with many sample based instruments) that are slow to load it can be simpler just to keep them open, although doing so will use more RAM.
10. When you play the main project file, its output will now include the rendered contents of your subproject.

Example

Let's now look at an example of how this might be done in practice. To make it easier to understand, this example will be kept to a simple project. After reading thru this, you might be able to then think of a further example that you can try out for yourself using your own projects.

1. Here we have created a new project file, and saved it into its own subdirectory, calling it **WaitingMain.RPP**, We have recorded a guide track and added a second track, called Drums.

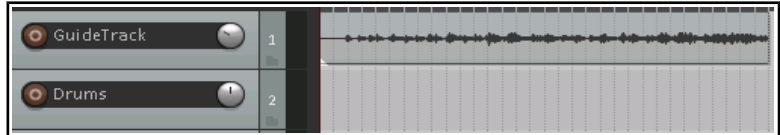

2. After selecting the Drums track we used the command **Insert, New subproject** to insert a subproject which we named and saved as **DrumsSub.RPP**. Notice both the short media item that is automatically added to the track and the new project tab above the toolbar.



3. Using **DrumsSub.RPP** we build our drum tracks in the normal way. For the sake of simplicity, in this example we have just added two tracks, but of course we could have as many as we require. Whenever we play these back, the guide track in the master project will also be heard. Track volume and pan settings are adjusted as required, FX and envelopes are added, and so on. When finished, we move the =END marker to the end of the tracks.

5. We now save this file. Notice that audio output is rendered as the file is saved. We return to the main project. At first sight, nothing seems to have changed:

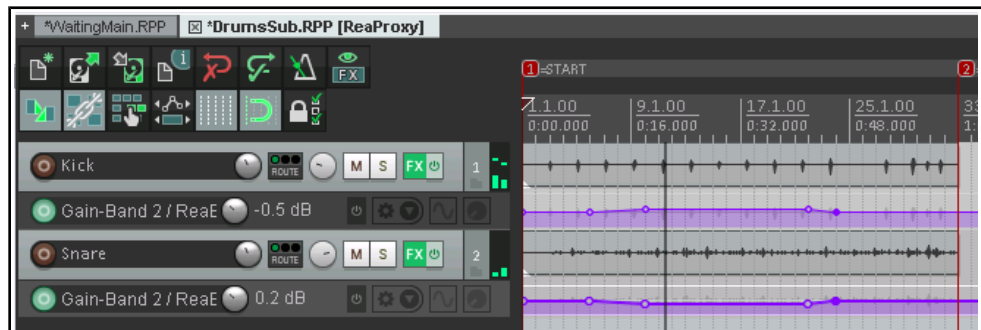

6. However, when we extend the media item to the right, we can see the rendered drums.

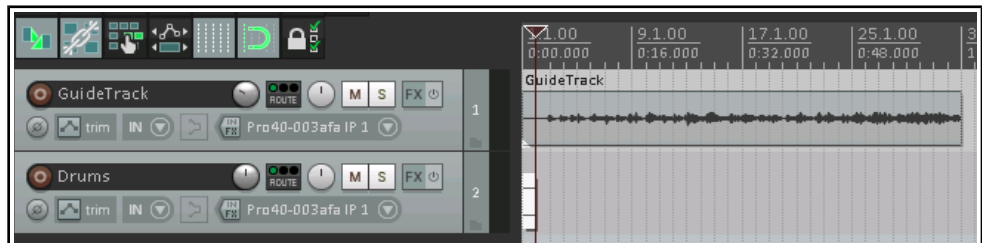

Up and Running: A REAPER User Guide v 7.31

7. If we close the DrumsSub project and play the main project file, the rendered drums can clearly be heard along with the guide track.
8. Any later changes that we make to the DrumsSub project will be included in the audio file that is rendered when the subproject is saved. Thus, when the main project is next opened, the audio item on the Drums track will include these updates.

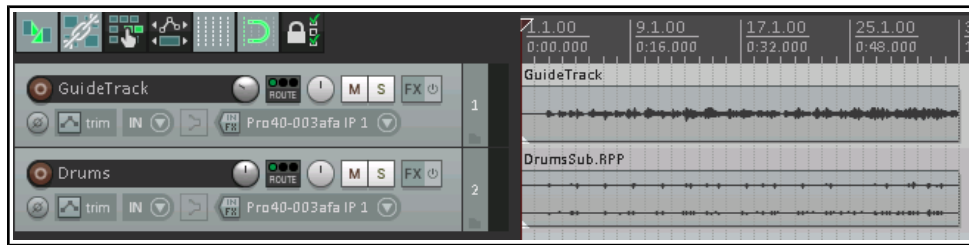

9. We can now add further subprojects, in this example one each for the vocals and the rhythm section. The guide track is no longer required: it can be muted and hidden. We can also make further edits, add FX, etc. to the rendered subproject tracks:

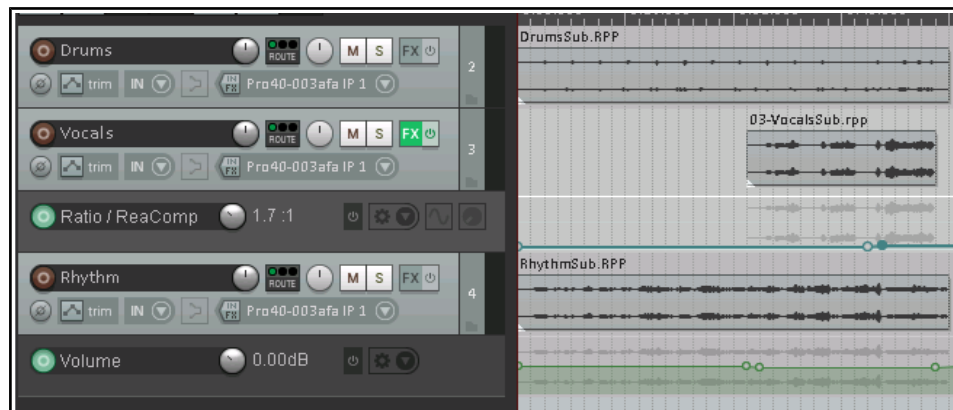

This example has been kept simple for learning purposes. In practise, subprojects are most useful when working with complex and

intense applications such as movie scores, radio programs, large orchestral arrangements, game/video sound design and electronic music production. Another potential application is in finalising an album, with each song being inserted as a separate subproject within a master project.

Working with subprojects ... some handy tips and hints

It's easy to stumble and make (sometimes elementary) mistakes when trying out something new. These comments are not comprehensive but they are here to help you.

Creating a subproject file

- It's not the end of the world if you forget to position the edit cursor in the master project accurately before creating a subproject. You can move the media item within the master project file later.
- You can specify the position and length of a subproject by defining a time selection before you create it.
- It usually pays to ensure that the master project is set up within a new folder, and the subprojects are all stored in that same folder.
- Don't use the name of an existing file in the same folder as a subproject file name. If you do, you will overwrite that file with a new empty one.
- Individual media items from an existing project file can be imported into a subproject file in the usual way (e.g. using REAPER's **Insert, Media item** command, or via the media explorer).
- An existing .RPP project file can be imported into a master project as a new subproject media item (see right).

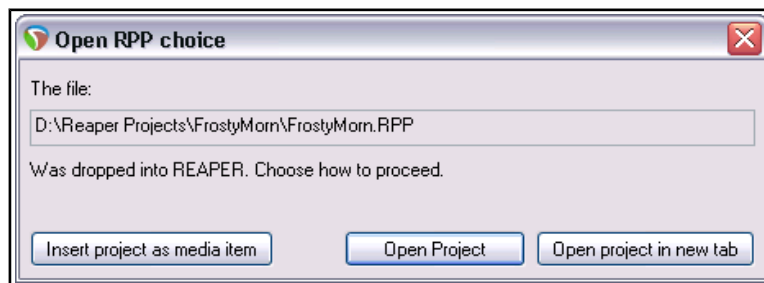

Managing The Overall Project

Either drag and drop the .RPP file from media explorer into an empty track in the master file, and when prompted choose **Insert project as media item**, or select the empty track and use the **Insert, Media file...** command.

- An existing media item (or item selection) in a master project file can be moved from the master file to a new subproject file. Right-click on the item(s) and choose **Move items to new subproject**. Items within the selection on the same track will be moved to a single subproject file. Items on different tracks will be each be moved into a separate subproject file. The subproject file is fully editable: its contents will appear in the master project as a single item, which will be updated each time the subproject is saved.
- An entire track or selection of existing tracks in a master project file can be converted into a subproject by following these steps:
 1. In the TCP, select the track or a number of tracks. If these are enclosed in a folder, include the folder in your selection.
 2. From the main menu, choose **Track, Move tracks to new subproject**.
The tracks (including any folders) will be moved and saved to a new subproject file: their output will appear in the master file as a rendered single item on a single track. Note, however, that any sends/receives between the selected tracks and any other tracks in the master file will be removed.

Working with subproject files

- If your master/subproject arrangements become very complicated, and you wish to be able to save without having to wait for rendering to complete, click on one of the project tabs and enable the option **Defer rendering of subprojects (render on tab switch rather than on save)**.
- A new subproject file will take some project settings (e.g. BPM, time sig) from the master project file. However, changes to master project settings will not be automatically applied to subprojects.
- You do not need to have the master file (or any other file) open when you are working on a subproject file. The file will be automatically re-rendered when you save your changes, and it is this re-rendered version that will be displayed when you next open the master file. However, often you will want to have the master project file open, to give your subproject file(s) relevant context.
- The =START and =END markers can be used to ensure that only a portion of the material in a subproject file is rendered and returned to the master file when the project is saved (shown below).

- If you delete these two markers, the entire project from the start (zero on timeline) to the end of the last item will be rendered when the file is saved. This could lead to the loss of reverb tails if the reverb is intended to play beyond the end of the last item.

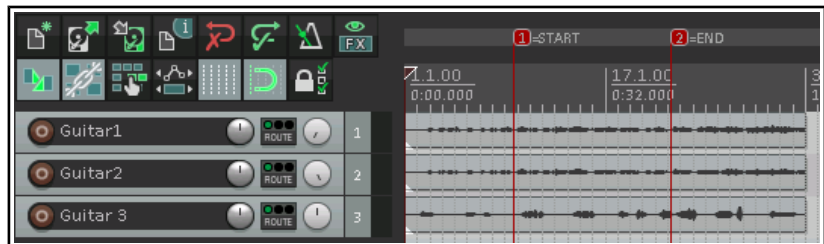

- When you play back a subproject file with **Run background projects** and **Synchronize any parent projects on playback** enabled, the item takes in the master file that correspond with that subproject file will be automatically muted, and remains so as long as that subproject remains the active project.. This prevents the same material from being played twice.
- If when working on a subproject file you wish to hear only the contents of that file on playback, you should disable the project tab option **Synchronize any parent projects on playback**.
- Be aware that if a subproject has been edited within the parent project (e.g. with FX, playrate changes, etc.) the **Synchronize any parent projects on playback** option may not produce the same results as playback of the parent project would provide.
- You have already learnt that when a subproject file is saved its contents are rendered to audio. This process uses that file's project render realtime/online settings. Thus, if you wish you can use different render settings for different subproject files.
- A subproject file can be auditioned in media explorer. Navigate to the correct folder, and select the .RPP project in the usual way. The audio render will be played. This enables you to play it back in media explorer without having to open it. Within media explorer, the **Options** menu includes **Auto-render**

proxy (subproject) to preview REAPER.RPP projects. If enabled, this ensures that when you select an .RPP subproject view for preview, if it needs rendering it will automatically be rendered.

- Within the main project file, you can create a new take of any subproject item. Just right-click on the media item and from the context menu choose **Open items in editor**, then **Open item copies in subproject tab**. You will now have two subproject files for this track. These two files can be edited independently of each other and will be displayed in the master project as two separate takes. They can be manipulated and edited in exactly the same way as any other takes.



- Your subproject files, like other project files, can include markers and regions, as you wish. On saving, any regions will be identifiable within that subproject's rendered media item in the main project file.

Summary of master and subproject project tab options

Parent projects:

If you enable the option **Run background projects** then you can fine tune how the background projects should behave by enabling or disabling any or all of the options **Run stopped background projects**, **Play stopped background projects with active project** and **Synchronize play start times w/play background projects**.

Subprojects:

If you enable the option **Run background projects** then you can fine tune how the background projects should behave by enabling or disabling any or all of the options **Synchronize any parent projects on playback**, **Run stopped background projects**, **Play stopped background projects with active project** and **Synchronize play start times w/play background projects**.

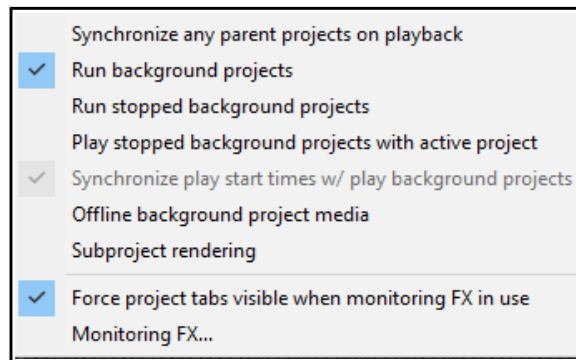

On both parent and subproject project tabs various **subproject rendering** toggle options are available.

These are **Do not automatically render subprojects (require manual render)**, **Prompt before automatic rerender of background subprojects**, **Defer rendering of subprojects (render on tab switch rather than save)** and **Leave subproject open in tab after automatic open and render**.

12.25 Working with Multiple Instances of REAPER

If you wish, you can have more than one instance of REAPER open at the same time. This can be useful, for example, if you have multiple monitors and need to work on two or more projects at the same time, with each project kept always in view. With project tabs this is not possible, but there are two other ways of doing this:

Spawn new instance of REAPER.

Open the [Action List](#) and run the action **File: Spawn new instance of REAPER**. This is the simpler option and will open a separate instance of REAPER in a new window and with its own preference options, but sharing the same configuration file. You can, for example, copy and/or move media items between the two (or, indeed more) instances. Each instance of REAPER is independent of the other. However, this method might not be preferred if your monitors are running at different resolutions.

Make a separate portable install of REAPER.

A [portable installation](#) of REAPER (in a different directory from your main REAPER installation) will have its own configuration file and settings. It can be run independently of, and alongside, your main REAPER version and allow you to do everything that you can do with a spawned new instance.

Working with MIDI Items

13 Working with MIDI Items

13.1 Introduction

REAPER has a number of techniques for manipulating and editing your MIDI items. In brief these are:

- Many of the commands on the arrange view right-click media item context menu can be used with MIDI items as much as they can with audio items – for example you can create and manipulate multiple takes, add MIDI FX to a take's FX chain, cut, copy and move items, and so on.
- In addition, there are commands on the arrange view right-click item context menu that are specific to MIDI items and only MIDI items. We'll get to these soon enough.
- You can open any MIDI items or selection of MIDI items in REAPER's MIDI Editor for detailed editing. You can choose either to open a single item, several items together in the same single MIDI Editor window, or to use a separate window for each item.
- For quick MIDI editing, you can edit the track in-line. This makes the item's content available for editing without needing to open a separate MIDI editing window. This is covered near the end of this chapter.

Before looking at editing, however, we'll resolve a couple of other issues of importance to MIDI users.

13.2 Monitoring an External Synthesizer

An external synthesizer can be monitored using MIDI or audio input. Just do this:

Activity	Procedures
Monitor using MIDI Input	Insert a track and name it. Arm it for recording and turn record monitoring on Set record mode to Disable (input monitoring only) Select Input: MIDI, then the device, then the channel(s) Open the track's routing (I/O) window, select your MIDI Hardware Output.
Monitor using Audio Input	Insert a track and name it. Arm it for recording turn record monitoring on Set record mode to Disable (input monitoring only) Select the necessary mono or stereo audio input from the synth's audio interface.

13.3 Using Track Controls with MIDI

As mentioned in Chapter 5, REAPER's track volume and pan controls by default control a track's audio signals. If you wish to use these for MIDI instead, you can do so. Right click on the track number in the TCP or MCP and choose **MIDI Track Controls** then select one of the **Link track volume/pan to MIDI** options from the menu. You can choose all channels or any individual channel.

You can also use the plug-in [ReaControl MIDI](#) with any track. This is explained in detail later in this chapter.

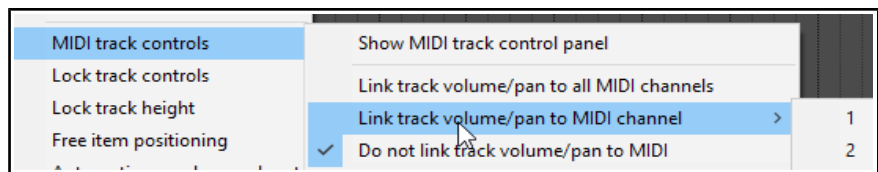

13.4 Controlling MIDI Data Sends

REAPER's sends and receives can be used with audio items, MIDI items, or both. You have already been introduced to this topic ([Chapter 5](#)), and it is covered in more depth in [Chapter 17](#). Meanwhile, note that the button indicated on the right can be used to ensure that a send's fader controls are used to control the MIDI data.



With this button enabled, CC messages CC07 for Volume (127, max) and CC10 Pan (64, center) are sent on the selected channels (by default, all channels). If there are any MIDI items (even empty ones) on the sending track, they are sent when transport starts or stops, or play position changes. However be aware that not all synths and plug-ins recognize this feature.

13.5 Configuring and Accessing the MIDI Editor

Note: Many of the illustrations used in this chapter use the REAPER 4 default color theme. The instructions and actions are nevertheless accurate for REAPER 5.

The MIDI Editor needs to be opened from an existing item. If you wish to open it with a “clean sheet” then you must first create a new empty MIDI item. To do this, select the required track and (optionally) make your time selection to define the length of the item. Then choose **Insert, New MIDI Item** from the main menu.

By default, MIDI items are loop enabled. You can change this individual items via their Media Item Properties dialog box, or globally on the [Preferences, Project, Item Loop Defaults](#) page of your Preferences settings.

The MIDI Editor can be opened by any of these methods, using a single MIDI item (either recorded or empty):

- Unless you have changed your default mouse modifier preferences, double-click on the MIDI item, or
- Select the MIDI item and press **Ctrl Alt E**
- Right-click on the item and choose **Open in built-in MIDI editor** from the menu.

Exactly how the MIDI Editor will behave when opened will depend on your Preferences settings. Before delving into the MIDI Editor, therefore, we really need to explore these preferences. Use the **Options, Preferences** command, then choose [Editing behavior, MIDI Editor](#) from the list to access the MIDI Editor preferences.

The wider range of MIDI Editor preferences is explored in Chapter 22. For now, we just need to focus on these:

First, you can specify what by default will be opened with the MIDI editor. This can be **clicked MIDI item only, all selected MIDI items, all MIDI on the same track, or all MIDI in the project**. The default is **All selected MIDI items**.

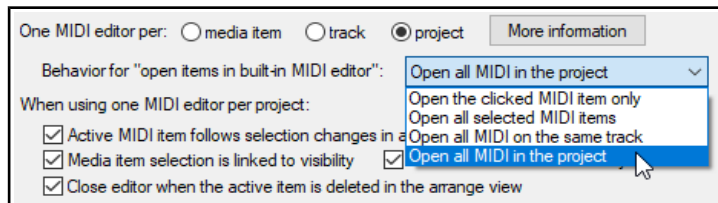

Clicking on **More information** will open a screen explaining in more detail just how REAPER handles these options.

You can override the default settings at any time by opening the MIDI Editor by right-clicking on an item (or a selection of items) and choosing **Open items in editor**, then, from the sub-menu, choosing either **Open items in built in MIDI editor**, **Open MIDI item in editor** or **Open item copies in built-in MIDI editor**.

You can also determine what is to happen when more than one MIDI item is open: you can choose to have a separate MIDI editor instance **per media item, per track** or just one editor for the whole **project**.

13.6 The MIDI Editor Window

The next part of this User Guide focuses on how to work in the MIDI Editor with a single item. Later in this chapter we will look at working in the MIDI Editor with multiple items, and with items on multiple tracks.

When you open an item in the MIDI Editor you will see a display similar to that shown below. It includes:

The Main Menu.

We'll take a detailed look at the main menu, its various commands and actions shortly: for now, note that if your MIDI Editor is docked, this menu is accessed by right-clicking on the windows docker tab. Meanwhile, you need to understand some more about the interface and how to navigate it.

The MIDI Toolbar (below Main Menu)

Hover your mouse over any button for a tooltip. You can [customize this toolbar](#) as you wish. (see Chapter 15).



Select View Buttons

The first four buttons select which view will be displayed in the MIDI Editor. From left to right, these are **Piano roll** (the default), **Named note**, **Event list** and **Musical notation**. The first three of these are explained in detail throughout this chapter. [Musical notation view](#) is dealt with in the chapter following this one.

The next three buttons determine how notes are displayed and are mutually exclusive. The first (the default) selects normal mode: the second and third, for use with drums, select triangular and diamond mode respectively.

Working with MIDI Items

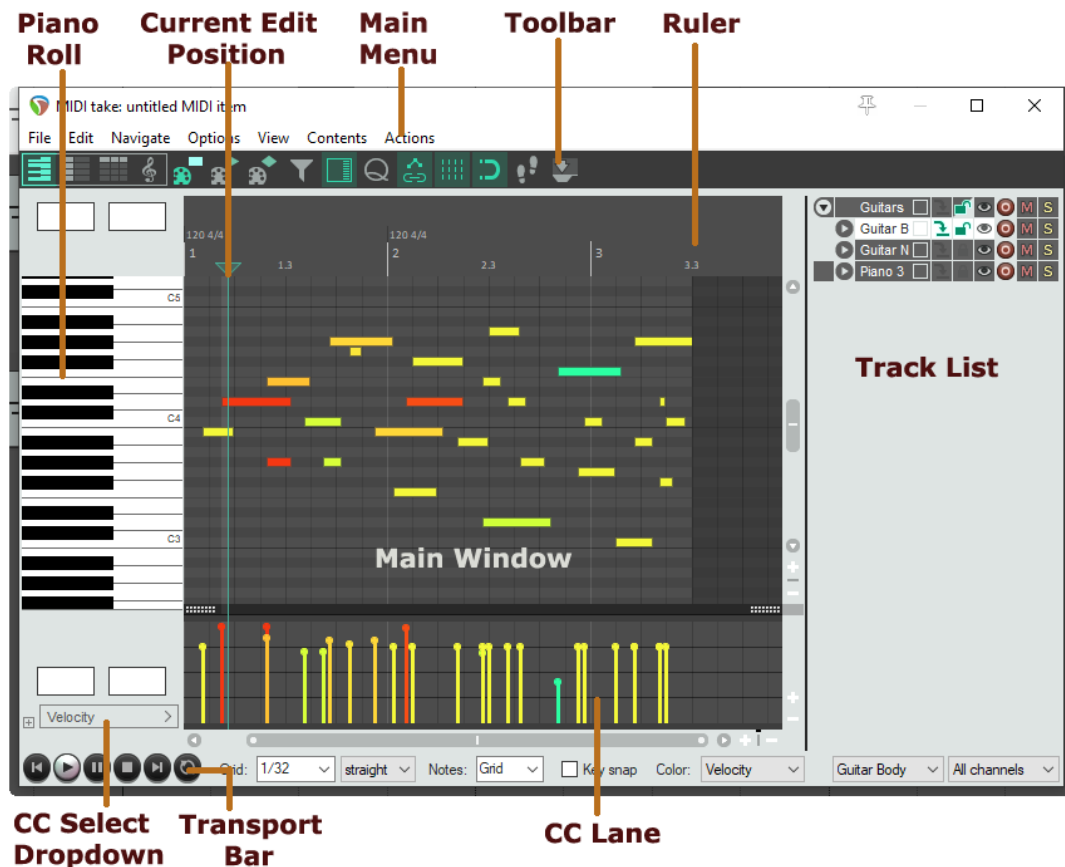

Filter Button

This is the eighth button shown on the toolbar above. It opens the Filter Events window to allow you to decide what you want displayed in the MIDI Editor. The **Show only events that pass filter** box toggles your filter settings on and off. **Invert** causes all notes to be displayed *except* those defined by the filter settings. You can choose to display all **Channels**, or any combination or permutation of channels.

Enabling **Solo** will cause only events that pass through the filter to be played.

Use the **Event Type** drop down to select any type of event as a filter. The default is **All events**, but you can choose Note, Poly Aftertouch, Control Change (CC), Program Change (PC), Channel Aftertouch, Pitch, or Sysex/Meta.

The content of the **Parameter** drop down lists depend on the event type selected. For example, for Note (as shown below), it will display a list of notes, with options to filter on note (optionally using the keys in piano roll) or note range, velocity, position in measure and/or length. However, choosing Program Change (PC) as event type will allow filtering only on program number and/or position in measure. Pitch can be filtered on low/high values or position in measure.

Position in measure behavior will vary with the event type. For example, if the event type is Note, position in measure allows you to restrict display to a range you define anywhere between 0 and 127. For PC, CC or Pitch, low and high position in measure values are set to any range within 1/32 and 1.

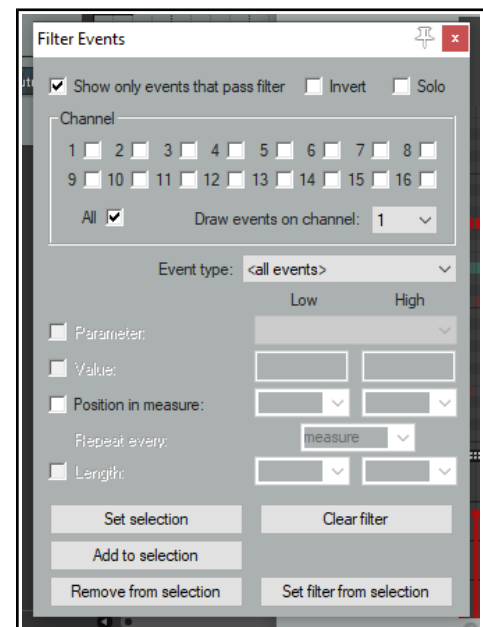

Up and Running: A REAPER User Guide v 7.31

Set selection causes current filter settings to be applied, and **Add to selection** lets you add to the existing filter selection. For example, you can create a filter on Note then add to it one based on Pitch. You can also specify settings to **Remove from (current) Selection**. **Set filter from selection** will automatically create a new filter based on the current MIDI Editor note selection.

The **Filter Button** includes a right-click context menu which can be used to toggle on/.off the options **Show only events that pass filter**, **Invert filter** and/or **Solo**.

Track List

This button opens (on) and closes (off) the Track List panel. This is explained in this chapter, in the section [Working with Multiple Tracks](#) and/or Items. For the time being, leave this set to off.

To the right of the track list button are six toggle icons, **Quantize** (on/off), **CC selection follows note selection**, **Show grid**, **Snap to grid**, **Step Sequencing** (use MIDI inputs for step recording, on/off) and **Dock editor**. Right-click over the Snap to Grid button to set behavior for when snap is enabled – **Always snap notes to the left**, **Snap notes to end of grid** (the default), or **Snap relative to grid**. The final icon **Dock editor** can be used to dock and undock the MIDI Editor window.

Note: If both Media, MIDI preferences to **Create new items as .MID files** and **Import existing MIDI files as .MID file reference** are enabled, the MIDI Editor toolbar will on the left display two further buttons - **File, Save MIDI file** and **File, Revert to saved MIDI file**.

Tip: The **View, Piano Roll Timebase** command includes the options source beats, project beats and project time. MIDI data is always defined in beat-based terms, but in the time view mode the grid is adjusted to reflect any tempo changes in the project. If there are no tempo changes, the beat and time views will be identical. You also have the option to select **Project synced**. This synchronizes the timeline of the project and MIDI item together. It also ensures that both windows are synchronized during such actions as zooming and scrolling.

The Ruler

The MIDI Editor follows your Arrange view settings. For example, if the option **Loop points linked to time selection** is enabled, click and drag along the MIDI Editor ruler will define both loop and time selection.

The Transport Bar



This is found at the bottom of the MIDI Editor window. It contains the transport buttons and a number of drop down lists. The six buttons (not shown) are self explanatory – left to right they are rewind, start, pause playback, stop playback, jump to end, and toggle repeat loop mode on/off. The loop area can be set on the timeline in either the MIDI Editor or the Arrange window. The drop down lists (shown above) from L to R are:

Grid: The grid division box is used to set the grid division unit, in notes. Select a values between 1/128 and 4.

Grid spacing type: Options here are straight, triplet, dotted or swing. If you choose swing, several other parameters will also be displayed on this bar. These are discussed later in the context of [quantizing](#).

Notes: This is used to select the default note length (expressed as a fraction of a note) that is used when new notes are added. In the example above, this has been set to be the same as the grid setting. It can be overwritten using the main menu command **Options, Drawing or selecting a note sets note length**.

Scale and Chord: Enabling the key snap option allows you to select a scale and a chord from the two drop down lists. You can also use the chords button (here labelled "Major") to load a REAPER .reascale file.

Track List: Where more than one track contains MIDI item, this selects which track is to be made active in the MIDI editor. This can also be used to show or hide the track list panel.

Channel: Use this to select a channel from 1 to 16 for current editing (or All). The **Filter** box modifies selected channel behavior: when off, all channels are displayed, but the selected channel is still used for note entry.

The Main Window

The main window by default consists of two panels. The larger (top) panel displays your MIDI notes. Here you do your editing. The default view is Piano Roll View. Click on any piano key to play that note. The smaller (bottom) panel is the CC lane, used to display various information, such as note velocity or pitch.

Move your mouse over the main window area (where the notes are displayed) and you can see your mouse cursor displayed as a pencil. This indicates the **current edit position**, for example for inserting notes. Both the position on the timeline and that on the piano roll are shown in the top left corner, just beneath the toolbar.

Working with MIDI Items

The Scroll Bars

The MIDI Editor window includes vertical and horizontal scroll bars which can be used to navigate and zoom in and out of the contents of the MIDI item(s).

The CC Lane(s)

By default, **Velocity** information is shown in the CC lanes. This can now include a visual display of the note length, as shown below (**Options, CC/Velocity lane, Show note length in velocity lane**). To change to another item, *either*:

- Click on the right pointing arrow (right) to see a menu of items (including standard MIDI control messages) that you can choose to display in the CC Lane instead of velocity. A small selection of the available choices is shown on the right, *or*
- Click on the small + button next to the drop down list arrow to add extra CC lanes. Select any item from the list to display it in the selected lane.

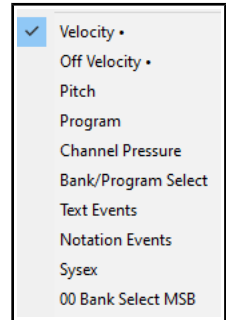
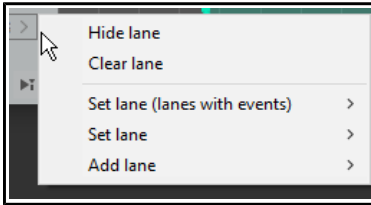

Right-clicking over the shaded area at the edge of the top border of a CC lane will produce the menu shown on the left. It can be used to hide a CC lane, clear it, change its contents, or add an extra lane. You can choose

from sub-menus of either only those with existing events or one of all lanes.

To remove a lane from view, click on the small minus sign that appears to the immediate right of its drop down arrow.

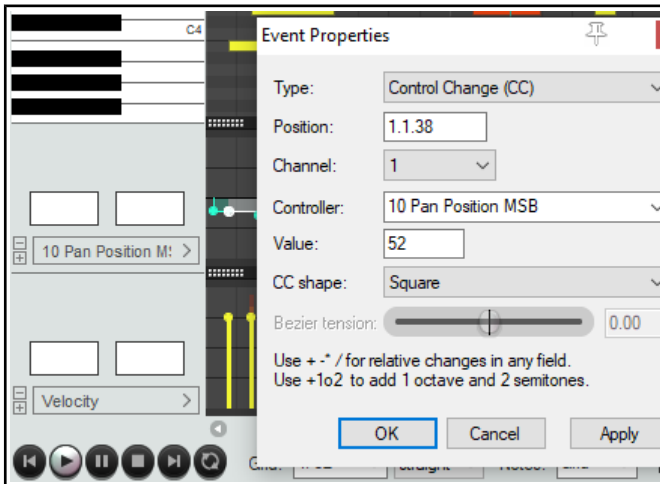

Provided the lane height is tall enough, the existence of CC messages can also be seen on the MIDI item in the main window (see left).

13.7 Control Change Messages

Control change messages are used to change the status of a MIDI parameter. If using an actual MIDI device, these messages can be used to physically control the foot pedals, volume sliders, modulation wheels, and other controls on electronic instruments. Within REAPER, control change messages can simulate this effect when playing back your MIDI data thru a software synthesizer.

Controller data is used for various purposes. The different controller data streams are numbered

from 0 to 127. Some of these controller numbers are industry standard. For example, controller 7 is generally used to control volume and controller 10 for panning. A control change message has two parts. The first is the control change number, which determines which parameter is to be set. The second is the desired value for that parameter. For example, first, you might send a CC #7 message to specify that you want to adjust volume. Next, you send a value that sets the actual volume level required.

A control change message can act as either an *override* (setting the parameter to the exact value specified), or an *offset* (adjusting the parameter up or down by the amount specified).

MSB and LSB

MSB and LSB stand for *Most Significant Byte* and *Least Significant Byte* respectively. MSB control change messages typically act as coarse controls, while LSB messages generally allow fine adjustments. Some control change messages have both MSB and LSB versions. Most MIDI devices that contain sounds/patches respond to both Bank Select MSB and LSB control change messages.

Some of the more commonly used cc parameters are listed below. Don't worry if you don't understand them all. You should consult your MIDI device's documentation for more details.

Parameter	Description
Bank Select MSB Bank Select LSB	Many MIDI devices offer a total of more than 128 instruments, in which case these instruments are grouped into banks. Thus, depending on the device, a full program change message might consist of five parts – cc #0 (Bank Select), followed by the Sound Bank MSB value, then cc #32 (Bank Select LSB) followed by the Sound Bank LSB value, then finally the Program Change number. Program change numbers are discussed in more detail in the sub sections that follow after this one.
Velocity	The measure of the speed with which a key on a keyboard is pressed. A lane is also available for Note Off Velocity .
Mod Wheel	This can add vibrato or other changes to a sound.
Breath	Varies from 0 (no force) up to 127 (high force).
Portamento	Determines the smoothness of the glide from note to note
Balance	Typically used to adjust the volume of stereo parts without affecting the panning.
Expression	Used to create relative volume changes.
Sound Timbre	The property of a sound that gives it its unique "color".
Sound Release	Determines how long it takes for a sound to fade out.
Sound Attack	Controls how long it takes for a sound to fade in.
Sound Brightness	This adjusts a sound's filter cutoff, allowing you to create filter "sweeps".

13.8 Control Change Basics

MIDI Data Control Change (CC) messages can be recorded during live performance, and edited or manually entered using the CC lane in the MIDI Editor. The CC Lane appears at the bottom of the MIDI Editor. Data is displayed horizontally according to its position on the Timeline, and vertically according to the value of the data. Where it makes sense to do so, you can cut/copy/paste CC events from one lane to another. Note that the edit cursor will be moved when you click your mouse in a CC lane.

Most CC data has a value of 0 at the bottom of the CC Lane, and 127 at the top of the CC Lane. The example (right) shows Velocity. Exceptions to this rule include Pitch, Pan and Pan Position, which are displayed as positive or negative variations from a centre line.

The information displayed in the CC Lane is selected from the drop-down list at the left of the window. Most CC events are displayed as linear and curved envelopes, similar to track envelopes (velocity being one exception). The topic of envelopes is covered in depth in [Chapter 18](#).

CC Data is entered or edited by double-clicking or clicking and dragging the mouse. To delete an event, select it, then press **Delete**. The default segment (point) shape is set on the [Editing Behavior, MIDI Editor](#) page of your **Preferences** (see below right).

Notice that as you sweep your mouse along the lane, the values at the current mouse position are displayed in the panel to its left.

The [Mouse Modifiers](#) page of REAPER's **Preferences** includes the ability to customize left drag and double-click behavior when working with MIDI CC events.

Some Notation Editor events can also be displayed in lanes, where they can be edited, moved or deleted, or new such events added – see [Editing Notation Events in Other Views](#).

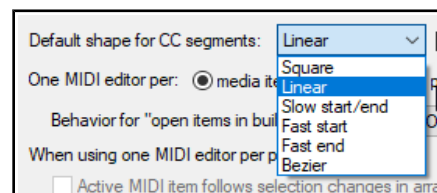
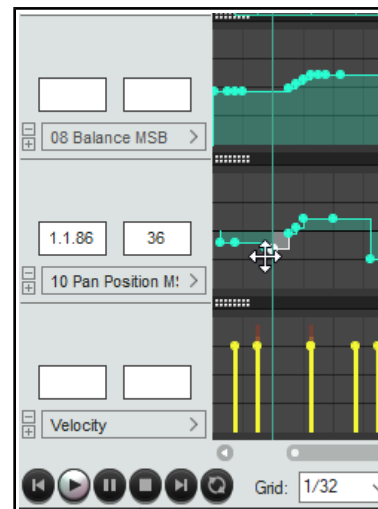

Working with MIDI Items

13.9 MIDI Editor CC Lanes

As discussed earlier, clicking on the small + (plus sign) to the right of the of the CC lane name will add a new lane. Clicking on the down arrow will display a list CC lane types (Bank Select, Mod Wheel, etc) from which you can make your choice.

Section 13.10 will show you the “nitty gritty” of working in these lanes – adding events, deleting events, etc. First, though, let’s take a closer look at the CC lane environment. Right click over the CC lane panel area to display a menu of options.

Select all events in lane

Unselect all events in lane

These are self-explanatory

Event properties ...

Displays the event properties dialog for selected item.

CC curve shape

Allows you to change the CC curve (envelope) shape for selected events. Available shapes are square, linear, square, slow start/end, fast start, fast end and bezier. See also [Chapter 18](#). Note that for parameters whose value is either on or off (such as Off Velocity) the only available shape is square.

Default CC curve shape

Allows you to change the default CC curve shape for new events.

Nudge events left/right

Move events left/right by grid

Nudge/move selected events in lane left or right.

LFO...

Adds a low frequency oscillator to either the entire lane or within the current time selection. LFO types are **straight**, **triplet**, **dotted** or **swing**.

LFO parameters are as shown here

There are a few interesting items that you can display in your lane or lanes that are worth a special mention, because they might otherwise slip under your radar. These include Notation Events, System Exclusive messages, Text Events, and Bank/Program Select.

13.9.1 Notation Events

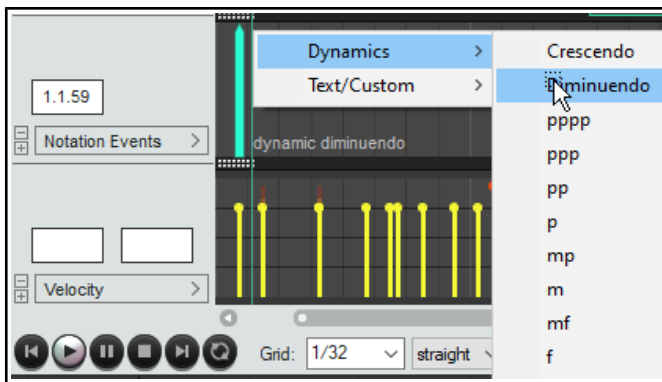

A Notation Events lane will display certain notation editor events, notably text and lyrics, tuplets and dynamics.

These can be edited (double click), deleted (select and press delete) or moved (drag).

You can also use this lane to add events to the notation. Right click at the required point in the CC lane and select from the menu.

The [notation editor](#) is explained in detail in the chapter following this one.

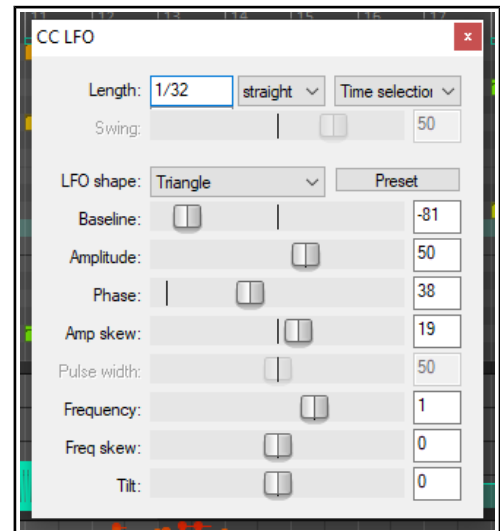
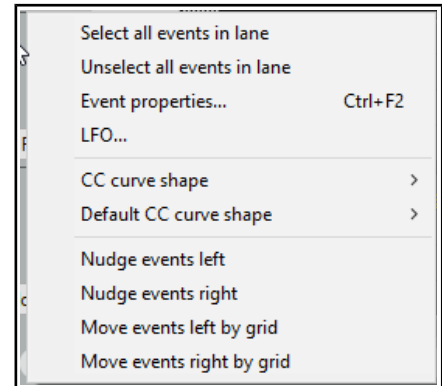

13.9.2 Sysex Events

System exclusive (Sysex) messages are MIDI data that is only understood by the make and model of the device that created them. For example, all synthesizers should respond to CC messages like Volume or Pan control, but system exclusive messages created by a Roland synthesizer would not be understood by, say, a Yamaha synthesizer.

You can add a lane to manage system exclusive (Sysex) messages. In this example, a Sysex lane is displayed in addition to a Velocity lane.

Some MIDI hardware, especially older devices, can accept sysex messages to initialize or change device settings. Sysex messages are raw MIDI data, represented as a list of hexadecimal bytes.

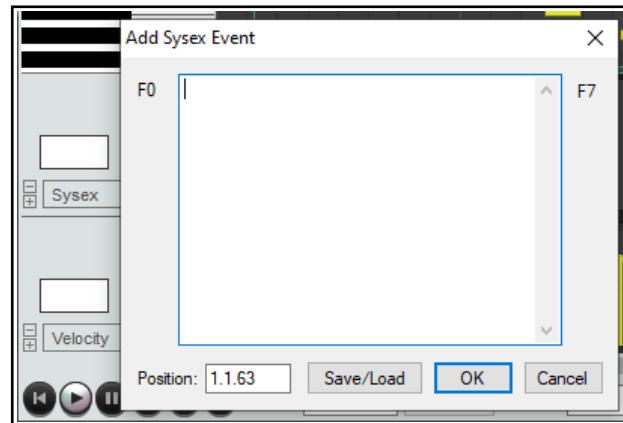

Sysex events may be added, edited, moved, or deleted in the same way as text events (see below). Double click in the lane to open the **Add Sysex Event** dialog box, enter the message and click on **OK**. Click, hold and drag on any sysex event to move it, press **Delete** to delete it. Double click on any existing sysex event to edit it, or right click for a menu of options which includes **Cut**, **Copy**, **Paste**, **Delete** and **Select all**. Other commands are **Right to left reading order**, **Show unicode control characters**, **Insert unicode control character**, and **Open IME**. Sysex events can be saved to, or loaded from, sysex (.syx) files, using the **Save/Load** button.

13.9.3 Text Events

The **Text Events** option lets you display a CC Lane which can be used to display text in a lane below your MIDI notes. These could be, for example, lyrics, or marker information or any of the other available text types.

Just double click at any point in the lane to open the **Edit Text Event** dialog box, type your text, specify its type, and click on **OK**. As with system exclusive events, double click on any existing text event to edit it, drag it to move it, right click to delete it.

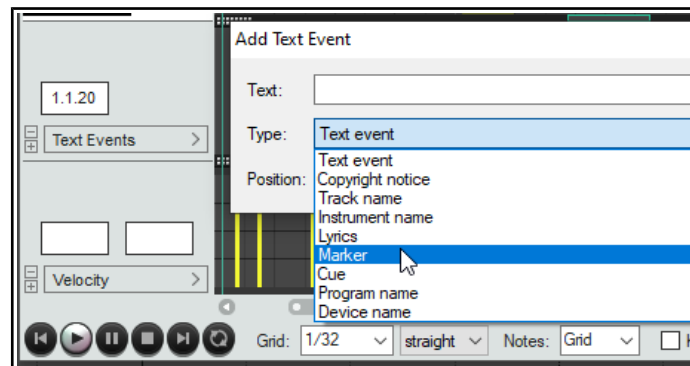

13.9.4 Bank/Program Select

When you choose the **Bank/Program Select** option for a CC lane, you can double click at any point to open the **Bank Program Select** dialog box.

Here you can select any bank/program combination, and assign it to any channel. The combinations available to you will depend on what instruments you are using (see example, right).

If using a synthesizer which has its own instrument definition files, you can load a file into the MIDI Editor by clicking on the **Load File** button to open the **Load MIDI instrument bank/program file** dialog.

Navigate to the correct directory and select the required file. There is an option to set this file to be used as your default bank/program file in future.

An example of program changes is shown here. To edit any program change message, just double click on its CC Lane bar. This will open the Bank/Program Select window. Also, click and drag to move a program change message, double-click to edit it. To delete it, simply right click over its CC Lane bar.

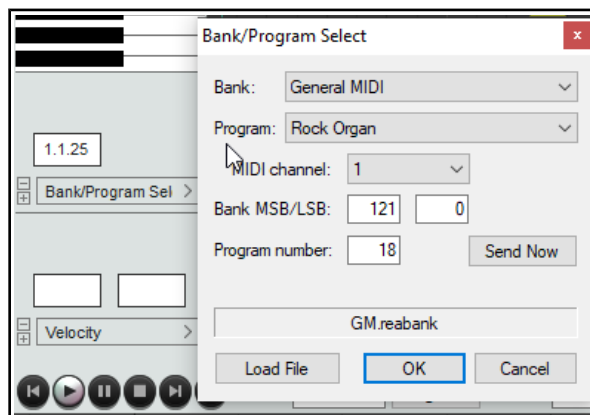

Working with MIDI Items

13.10 MIDI CC Lanes: Tips & Tricks

REAPER's MIDI CC lanes additional features are described here. There are also a number of [preferences](#) to determine how – and how many – CC lanes are displayed. At least one lane will always be displayed in arrange view (space permitting).

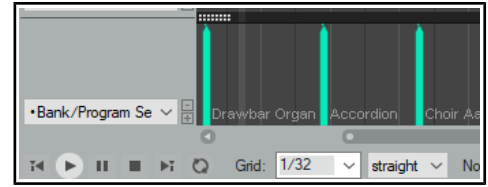

13.10.1 General CC Lane Editing Techniques

Many of the CC message types – such as Mod Wheel, Breath, Portamento, Pan, Volume etc. – can be expressed either as a continuous range of values or as discrete items. For messages of this type there are a number of standard techniques you can use to enter, edit or delete them.

- To make a single entry, double click in the appropriate CC lane at the required point. The nearer the top of the lane, the higher the value of the message. The entry point can then be dragged as required (right). To delete a point, use Alt click.
- To add a point to an existing envelope, **Shift click** on the envelope. To edit a point and view/change any of its properties, **Shift double-click**.
- To enter data as a continuous sweep, use mouse pencil to click and drag (below right).
- To delete a message, right click over it. Alt right click sweep will delete a series of messages.
- For items that take discrete values only (e.g. Velocity), double-click to enter a data point, click drag up/down to change value.
- Double-click in the CC lane header area (left of event display) to select all events.
- For vertical zoom within a CC lane use Ctrl Mouse wheel: for horizontal zoom use Ctrl Alt Mouse wheel. For scroll use Alt Mouse wheel.

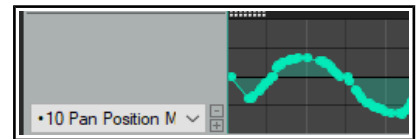
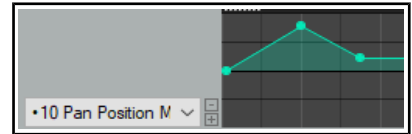

13.10.2 Right Click Marquee Selection

Right-click and drag within any CC lane to select multiple events. You can work with your selection in the CC lane, as well as (if appropriate) in the piano view window. For example, if the CC lane displays Velocity, then there will be one event shown in the CC lane for each note in the piano view. Selecting events in the CC lane will select those same events in piano roll view. You can work with selected events in the MIDI Editor or in the CC lane itself. For example you can:

- Delete them or adjust their values (up or down).
- Right click over the CC lane for a context menu (see right), including nudge or move events.
- Click and drag to move the selection left or right, control click and drag to copy.

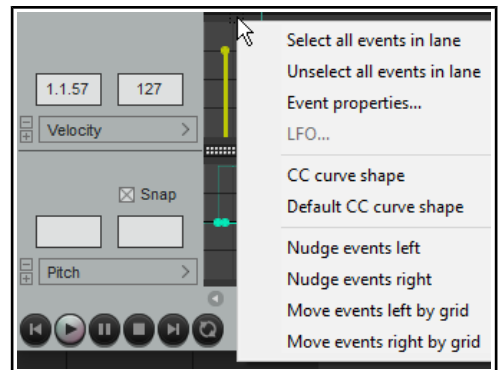

The exact behavior depends on whether individual CC events are directly linked to individual notes. For example this would usually apply to velocity events but not to pitch change events. Thus, you would need to move the notes in the piano view window and the velocity events would move with them. You would move pitch change events in the CC lane itself.

13.10.3 Managing CC Lanes

The CC Lane dropdown menu includes **Set lane (lanes with events)** which will display a list of all lanes that already contain data, whether they are currently displayed or not. Shown here, this includes Velocity, Off Velocity and Pitch. Select one to display that lane. When using the pitch lane, you can set a custom pitchwheel range (in semitones), by right clicking over the text "Snap" and typing a number. Optionally, you can also engage the snap option. Additionally, the MIDI actions list includes actions for doing this.



To scroll through the list of available CC lanes: to do this, hover your mouse over the currently displayed name and scroll with the mousewheel (see left).

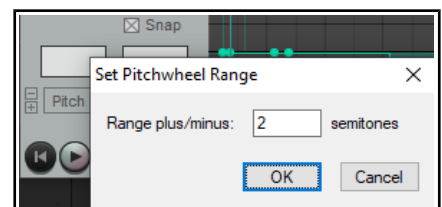
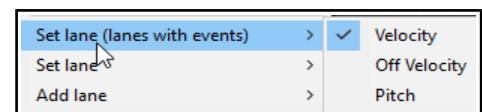

13.10.4 Renaming CC Lanes

You can rename CC Lanes, importing your preferred names from a previously saved note names file. This is explained in detail [at the end of this chapter](#).

13.10.5 14-bit CC Lanes and Actions

The CC Lane drop down menu includes a complete range of options for 14-bit CC messages. These can be found at the end of the drop down list. There are also actions that can be used to select any message type for any lane. Use of the [Actions List Editor](#) is explained in detail in Chapter 15, but in brief:

1. From the MIDI Editor **Actions** menu choose **Show action list ...**
2. In the Action List, select one of the actions **CC: Set CC lane to ...** (e.g. *Set CC lane to 007 Volume 14-bit* or *Set CC lane to 007 Volume MSB*). You can now assign a shortcut key to that action (see Chapter 15). Close the Action List Editor.
3. Now you can at any time select a MIDI Editor CC lane and use the shortcut key to use that CC lane for the chosen message type: existing data will be displayed and new data can be inserted and/or edited.

13.10.6 Resizing CC Lane Height

You have three options for changing the height of CC lanes. All involve clicking on the dotted "handle" (shown here) on the "ceiling" boundary above the CC lane in question. The mouse cursor becomes a vertical double-headed black arrow. You can then drag the mouse up or down. When you have only one CC lane displayed all three actions do exactly the same thing. However, when there are two or more CC lanes shown, these three actions will behave differently.

Control Click and Drag: Simply click and drag up/down to increase/decrease the portion of the MIDI Editor window used to show the selected CC lane. Increasing this portion will decrease the height of the piano roll window and vice versa. Other CC lane heights remains unaffected.

Shift Click and Drag: Shift click and drag up/down will increase/decrease the height of all CC lanes and adjust the height of the piano roll window accordingly.

Click and Drag: Control click and drag will adjust the height of just the one CC lane, leaving other CC lane heights unchanged.

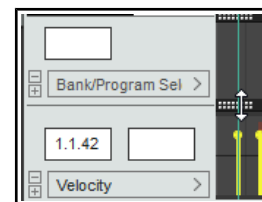

In addition, you can double-click on the dotted handle (also known as "grippy area") of any open CC lane to toggle between viewing and minimising it.

13.11 Navigating the MIDI Editor Main Window

The MIDI Editor's menus and action list contain any number of techniques that you can use for precision navigation: we'll get to these shortly. First, you should familiarise yourself with the tools that you have available for "broad brush" navigation. The horizontal and vertical scroll bars in the MIDI Editor window are used for scrolling, and their respective plus and minus buttons can be used for vertical and horizontal zooming. You can also use your mousewheel. This can be customized in the [Actions List Editor](#) (see Chapter 15), but by default the settings are:

Mousewheel: Horizontal Zoom

Ctrl Mousewheel: Vertical Zoom

Alt Mousewheel: Horizontal Scroll

Ctrl Alt Mousewheel: Vertical Scroll

The keyboard shortcuts **PageUp** and **PageDown** can be used to zoom in/out vertically, and **+** and **-** to zoom in and out horizontally. These too can be changed in the Actions List Editor if you wish.

13.12 Basic Note Selection and Manipulation

The MIDI Editor's menus and action list contain any number of techniques that you can use for precision editing and manipulation of your notes: we'll get to these shortly. First, you should familiarise yourself with the most basic tools that you have available for quick and basic editing.

To do this ...	You need to do this ...
Add a note	Click and drag in the MIDI editing area.
Delete a note	Double-click on the note.
Select a note for editing	Click once on the note.

Working with MIDI Items

To do this ...	You need to do this ...
Select a range of notes	Right click and drag around the selection.
Select all notes in a range	Right click and drag keys in piano roll.
Add to an existing selection	Hold Alt and Ctrl while right clicking and dragging around notes.
Change a note's length	Hover mouse over the start or end of the note - the mouse cursor is now a double headed black arrow. Click and drag left or right , as required.
Move a note	Click and drag note to new position then release.

13.13 Loop/Time Selections and Smart Editing

To move the position of the cursor, click on the timeline (ruler) in the MIDI Editor window.

Loop and time selection within the MIDI Editor will behave in accordance with whether or not you have enabled the option **Loop points linked to time selection** on REAPER's main **Options** menu. These notes assume that you have this disabled.

You can select an area to be looped, as in the main REAPER window, by clicking and dragging along the MIDI Editor timeline (see above right). You can also use the REAPER arrange view timeline to define and modify loop areas if you wish. Use the **Toggle Repeat** button on the MIDI Editor Transport Bar to enable or disable looping.

To make a time selection, click and drag along the boundary between the piano roll display area and the CC lane (see right). The mouse cursor becomes a horizontal double-headed arrow. Notice that the time selection is mirrored in REAPER's Arrange view.

This facilitates **smart editing** (see Chapter 7). For example, within the docked MIDI Editor window you could work on the part of a MIDI item that you wish to copy or move to another track and then, still in the MIDI editor, mark that as a time selection.

In Arrange view, you could then **Ctrl Click Drag** that area to another track (or elsewhere on the same track) and create your copy. If using this feature, you should first decide whether or not you wish to enable **Auto-select CC when moving/copying within time selection** from the **Options** menu.

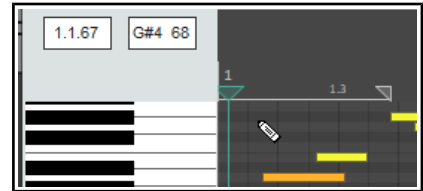

13.14 The MIDI Editor Menus

This section is an overview of the MIDI Editor's main menu commands. When docked, the main menu is not displayed, but you can access these commands by right-clicking over the window's tab in the docker. You can also access the MIDI Editor menu by right-clicking just above the piano keys or timeline.

The File Menu

Rename MIDI take ...

Renames the MIDI Item.

Export to new MIDI file ...

Exports active MIDI track to a file. MIDI events are normally stored in the Project file itself.

Notation: Export as MusicXML

Available in musical notation view only – [see next chapter](#).

Lyrics

Used to import or export track lyrics in .txt format. Mostly useful with [Notation Editor](#).

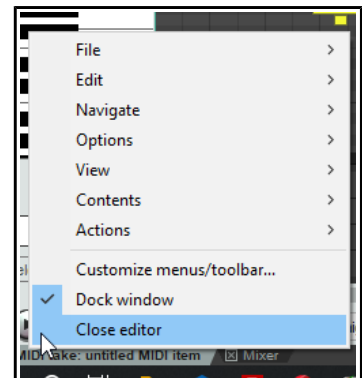

Up and Running: A REAPER User Guide v 7.31

Note/CC names

Displays a sub-menu. **Rename last clicked note...** Use this in Piano Roll or Named Notes mode to name the currently selected note. After entering a name you can use **Tab** to move to the next note in the piano roll, **Shift Tab** to go to the previous note. **Rename last clicked CC lane ...** allows you to select a CC lane (in piano roll or named note view) and rename it.

Choose **Load note/CC names from file...** to browse the file list. Recently used files will also be displayed on the menu. When loading from the recent file list, hold **Shift** with this command to merge imported names with existing note names rather than replace them. See also [Custom MIDI note and CC names](#).

Another option is to **Save note/CC names to file...**

There is an option to **Clear note/CC names** and a toggle option **Note name actions apply to active channel only**.

Scale/chord definitions

Displays a sub-menu. **Load/Unload ReaScale file**. ReaScale files can include scale definitions, chord keymaps, etc.

Close Editor

Closes the REAPER MIDI editor, and returns you to the main REAPER window.

The Edit Menu

Undo, Redo, Copy, Cut, Paste, Select all, Delete

These features work as expected on all selected MIDI notes. Note that you can cut, copy and paste between MIDI Editor windows, and into some external applications.

Also, the **Actions list** includes several **Select** actions, e.g. various actions for selecting CC events in time selection, actions to select CC events under selected notes, actions to select muted notes, actions for selecting all notes in measure, and actions for selecting all notes at pitch cursor.

Paste, Paste preserving position in measure

Paste will paste to the current cursor position. Where a selection of notes (rather than a single note) has been cut or copied, the entire selection will be pasted starting at the current cursor position.

Paste preserving position in measure pastes to the next measure after the cursor position, retaining the relative position of the item pasted.

Select all

Selects all notes.

Delete

Deletes current note selection.

Mute

Mutes current note selection.

Insert note

Inserts new notes at the Edit Cursor.

Split notes

Splits selected notes (using the S key). If no notes are currently selected, all notes currently under the Edit Cursor are split.

Join notes

Joins selected notes together.

Set note ends to start of next note (legato)

Sets ends of selected notes to start of next notes by adjusting end points of all notes in selected range.

Quantize ...

Opens Quantize Events dialog box. See also the [Quantize](#) section and the MIDI Toolbox section.

Quantize submenu:

Quantize using last settings

Quantize position to grid

Unquantize

Freeze quantization

See the [Quantize](#) section for more information.

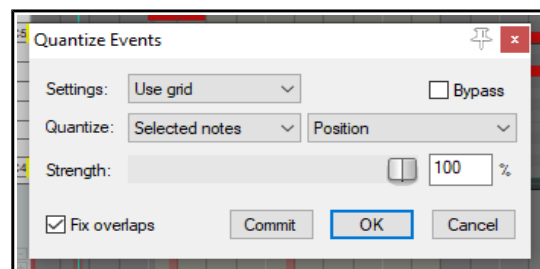

Working with MIDI Items

Humanize ...

Opens the dialog box shown here. Humanizing can make the exact timing of MIDI generated music sound less “clinical” and more realistic. It does this by allowing you to introduce random small and subtle imprecisions in timing and velocity. This command is also available as an assignable action.

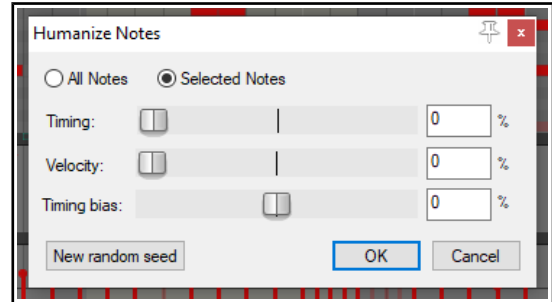

Transpose ...

Opens the dialog box shown below, which can be used to transpose all or a selection of MIDI notes. You can transpose by a specified number of semitones, with a snap to scale option, or from one specified key/scale to another.

The Navigate Menu

This menu presents a number of options for moving notes in any direction, either by grid or by note:

Move cursor left by grid **Move pitch cursor up a semitone**
Move cursor right by grid **Move pitch cursor down semitone**

The following commands can be used to jump to and select a note, either instead of or in addition to any current selection:

- Select note nearest cursor**
- Add note nearest cursor to selection**
- Select previous note**
- Select next note**
- Select previous note with same pitch**
- Select next note with same pitch**
- Select all notes with same pitch**
- Add previous note to selection**
- Add next note to selection**
- Move edit cursor to start of selection**

More note selection actions are available in the MIDI Editor's action list, including actions to select the next note with higher or lower pitch.

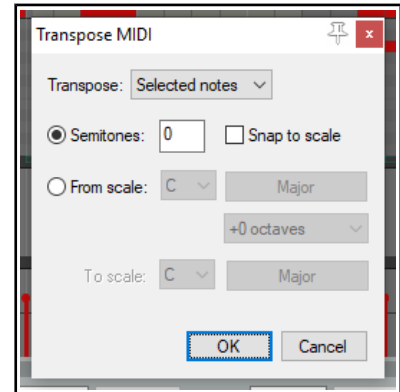

The Options Menu

Dock window

Moves MIDI Editor to the Docker. The MIDI Editor's main menu will no longer be displayed. This menu can then be accessed by right-clicking over the window's tab in the docker (right).

Sync editor transport to project transport

Synchronizes MIDI Editor transport to REAPER's main Timeline.

Use the same grid division in arrange view and MIDI editor

This makes the displays in arrange view and the MIDI editor consistent with each other.

Chase MIDI note-ons in project playback

When playback starts anywhere other than at the very start of a project, notes that begin just before the playback position might not be heard. This could be the case, for example, if you start playback in the middle of a long note. Leaving this option on prevents this from happening.

Time format for ruler, transport, event properties

Gives you the choice of **Measures.Beats.100ths** or **Measures.Beats.MIDI_ticks** and option for **Ruler in Measures.Beats only**.

Snap Settings

Displays sub-menu of snap toggle options: **Snap notes/CC to grid**, **Soft snap notes to other notes**, **Always snap notes/CC to the left**, **Snap note ends to grid** and **Snap notes/CC relative to grid**.

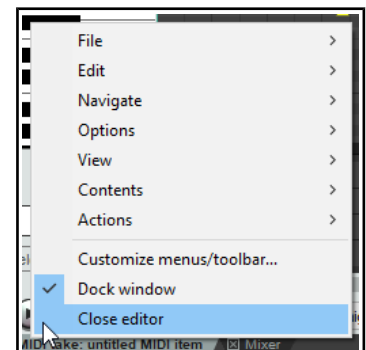

Note preview

Displays a sub-menu enabling you to select any or all of four situations when you would like notes to be previewed (i.e. audibly heard) – **Preview notes when inserting or editing**, **On velocity change**, **On keyboard action**, and/or **All selected notes that overlap with selected note**.

CC events in multiple media items

Options are available to **Draw and edit on all tracks**, **Edit on all tracks**, or **Do not draw CC events in non-editable contexts**.

CC/velocity lane: Several options are available:

CC selection follows note selection and **Bank program selection follows note selection**
Default CC curve shape and **Reduce CC events while drawing**
Apply default CC shape to recorded events
Allow CC shape in bank and LSB lanes
Show note length in velocity lane and
Edit CC/velocity only when mouse is near event.

Drawing or selecting a note sets the new note length

Over-rides the default note length set by the drop down Notes box on transport bar.

Selecting a single note sets the channel for new events

Causes channel for new events to automatically follow channel of last selected note.

Allow MIDI note edit to extend the media item

Ensures the media item length will be extended when a note is moved or copied within a time selection.

Display 14-bit MSB/LSB CC data as a single entry ...

If enabled, ensures that 14-bit MSB/LSB CC data will be shown as a single entry (rather than separate entries) in event list view and properties,

Automatically correct overlapping notes

Toggles on and off the automatic correction of overlapping notes.

Use F1-F12 for step recording (see also section "Step Recording")

When enabled, the function keys (F1 - F12) can be used to enter notes. These keys are mapped to the 12 Semitones of an Octave, with F1 having the lowest pitch and F12 having the highest pitch. The starting pitch for F1 is set by the location of the highlight bar.

To bypass any snap settings when using step recording, hold **Shift** while pressing the function key.

Use all MIDI inputs for step recording

Toggles the use of MIDI inputs when step recording.

MIDI editor mouse modifiers

Opens the mouse modifiers page of your preferences window. Here you can select actions to be assigned to mouse behavior in various contexts. This is discussed [later in this chapter](#) and in [Chapter 15](#).

Customize menus/toolbars ...

Opens the Customize Menus/Toolbars window. See [Chapter 15](#).

The View Menu

Filter events..., Quantize..., Humanize..., Transpose ...

Opens one of these dialog boxes, which are individually discussed elsewhere in this chapter.

Event properties ...

Opens the Note properties dialog box. This topic is covered later in this chapter. Note properties now share this common dialog box with other events including control change, pitch, and channel pressures.

Raw MIDI data

Opens a window displaying raw MIDI data for currently selected item.

Mode: piano roll

Displays a standard, white/black piano key view. This is the mode most commonly used for MIDI editing.

Mode: named notes

Replaces the Piano Roll view with note names. Note: Only works when using a VSTi that reports note names, such as Expansion's BFD. Check the REAPER forum to see if a note namer plug-in has been posted for the VSTi you want to use. For example there are EZDrummer note namers available.

Mode: event list

Displays the event list. This is explained later in this chapter.

Working with MIDI Items

Mode: musical notation

Displays MIDI notes in musical notation view. See [next chapter](#).

Piano roll notes

Displays a sub menu of **Rectangles**, **Triangles** and **Diamonds** to determine how notes are displayed. There are toggle options to **Show velocity handles on notes**, **Show velocity numbers on notes**, **Show note names on notes**, **Show notation text on notes** and/or **Show velocity and names only on active media item**. The example here shows, velocity handles and note names.

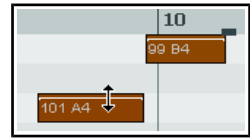

Color notes by

Selects the criteria used for coloring notes. Options are **Velocity**, **Channel**, **Pitch**, **Source (using color map)**, **Track**, **Media item** and **Voice**. When coloring by track or media item, you can choose to **Use theme color** for any or all of **selected note body**, **selected note border**, **unselected note body**, and **unselected note border**. Note that the MIDI editor actions list includes the action **View: Load note color map from file**, as well as options to set color map by track or by media item, as you prefer.

Show/hide note rows.

Displays a sub-menu with four options: **Show all note rows**, **Hide unused note rows**, **Hide unused and unnamed note rows** or **Show custom note row view**. Hide options exclude piano roll view.

Piano roll ruler

Provides options to display or hide **project markers**, **project regions** and/or **tempo/time signature markers** on the piano roll ruler. These are displayed above the ruler, and tempo/time signature markers can be edited by double-clicking on them. You can also right-click for a context menu.

Piano roll timebase

Sets the timebase for the piano roll. Options are **Project beats** (the default), **Source beats** (from media source item), **Project time**, or **Project synced** (which syncs the piano roll timebase to arrange view). For more information, choose **Timebase help** from this menu. If you are opening several MIDI items in a single MIDI editor, then choosing source beats can cause some MIDI editor functions to be disabled.

Notation view options

Displays a sub-menu of various options that are only relevant when working in [notation view](#). These are explained in the chapter immediately following this one.

The Contents Menu

Track List/Media Item Lane

Toggles the display of these panels which list and display tracks and MIDI items respectively.

One MIDI editor per

Opens sub menu where you can specify one MIDI editor window for each item, each track, or the project.

Behavior for "open items in built-in MIDI editor"

Select whether opening items in arrange view, using the media item menu, should **Open the clicked item only**, **Open all selected MIDI items**, **Open all MIDI items on the same track as the clicked item** or **Open all MIDI in the project**.

Options when using one MIDI editor per project

Options are **Active MIDI item follows selection in main view**, **Media item is linked to visibility** and **Media item selection is linked to visibility**. There is also an option to **Close editor when active media item is deleted in arrange view**. See section ["Managing Multiple MIDI Tracks and Items."](#)

All media items to be editable in notation view: a toggle option.

List of project tracks/MIDI items

This menu lists all tracks which contain MIDI items and all items themselves. A tick indicates that the item is currently open and the active item. Select an item from this menu to open it in the MIDI Editor window, closing all other items: hold Shift while doing so if you do not wish to close all other items.

The Actions Menu

This has two default commands - **Show action list** and **Show recent actions**. **Show action list** opens the **Actions ...** window with the **MIDI Editor** section automatically selected. When **Show recent actions** is enabled, the Actions menu will list your most recent activities and actions on this menu (see right). Some examples appear later in this chapter. The [Actions List Editor](#) is covered in detail in Chapter 15.

13.15 Note Creating and Editing

Overview

A MIDI Item can contain data from up to 16 channels. The MIDI Editor can display and edit all 16 MIDI channels, or you can use the Filter Events window or Channels drop down list to limit the channel display.

If you select Channel from the Color drop down list, each channel will be assigned an individual color, visible in both the Piano Roll and the CC lane. The MIDI Editor uses as its default a Piano Roll interface to display and edit MIDI information. Notes are displayed vertically according to their corresponding value on a Piano Keyboard, and horizontally according to the duration of each note and their location within the MIDI Item or the Timeline.

Preview Keyboard

The Preview Keyboard at the left of the screen provides a visual representation of the value of the notes on the Piano Roll, and allows you to audition a note without having to enter or edit it first. Clicking a key on the Preview Keyboard will send a MIDI note of the corresponding value to the MIDI Instrument that is connected to the Track. The Preview Keyboard can mimic a velocity sensitive keyboard. Clicking on the far left of a key will generate a soft note, while clicking on the far right of a key will generate a loud note.

Entering / Editing Notes

MIDI notes can be recorded as part of a performance, imported from an existing MIDI file, or they can be manually entered using the MIDI Editor.

Using the Mouse:

Notes can be entered by dragging your mouse from left to right across the Piano Roll. The duration of the note will increase as you drag the Note. If Snap is enabled, the duration will Snap to the nearest Grid Line (depending on the strength of your Snap settings). Notes can also be entered by double-clicking on the Piano Roll (in a space not already occupied by another note). In this case, the duration of the note is determined by the value of the Grid Setting. Notes can be deleted by double-clicking on the Note.

The duration of an existing note can be altered by dragging the edge of the note. While holding it, you can drag the note out, move it up and down, etc. When you let go, the notes will be positioned according to your snap setting. A note's velocity can be adjusted by clicking and dragging up or down from the top of the note, in similar fashion to that used for adjusting the item volume button or handle in REAPER's main window. Notes can be moved by dragging in any direction. Dragging left or right will change the location of the note in the Timeline, while dragging up or down will change the note value.

The Right-Click Piano Roll Context Menu

Copy/Cut/Paste

These are standard Windows editing commands which perform standard Windows functions.

Paste preserving position in measure

This pastes notes to the next measure after the cursor, retaining the relative position of the item(s) pasted.

Select all

Selects all notes in this MIDI Editor window

Delete

Deletes all notes in current selection.

Mute

Mutes according to context the current note selection or the note under the mouse cursor.

Insert note

A very quick way to insert notes. Inserts notes according to the current snap values at the edit/play cursor position.

Split notes

Notes can be split at the Edit Cursor by selecting **Split notes (S)** from the right-click menu. All notes that are under the Edit Cursor will be split.

Copy	Ctrl+C
Cut	Ctrl+X
Paste	Ctrl+V
Paste preserving position in measure	Ctrl+Shift+V
Select all	
Delete	
Mute	Alt+M
Insert note	Shift+I
Split notes	S
Join notes	J
Set note ends to start of next note (legato)	
Select previous note	
Select next note	
Select previous note with same pitch	
Select next note with same pitch	
Select all notes with same pitch	
Rename current note...	
Event properties...	Ctrl+F2
Note channel	>
Note velocity	>
Notation	>

Working with MIDI Items

Join notes

Joins all notes in current selection to make one note per row.

Set note ends to start of next note

Extends the end of each note in a selection to the start position of the next note in the selection.

Select previous note/ Select next note

Selects previous or next note in place of current selection.

Select previous note with same pitch

Select next note with same pitch

Select all notes with same pitch

Selects previous, next or all notes with the same pitch as the currently selected note.

Rename current note

Allows you to rename in the piano roll the note underneath the mouse cursor.

Event properties (see right)

Certain events can be edited by entering values into text boxes. For example, for notes you can change **position, length, channel, note, velocity, off value**. You can use + or – to make relative changes. For example, for note value, entering +1o2 will raise the pitch by one octave and two semitones. You can also enter note names directly into this field.

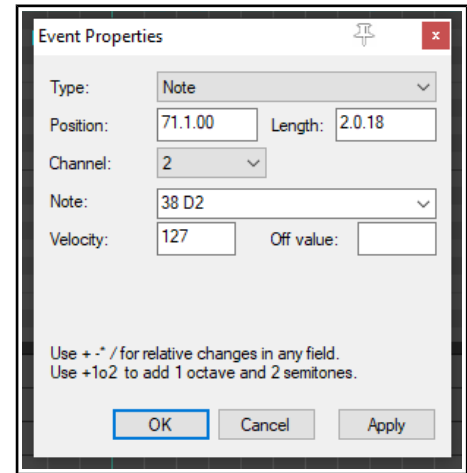

Other editable events include poly aftertouch, control change, program change, pitch, and song select.

Note channel (1-16)

A quick way to change the channel for the current note selection. For example, choosing channel 8 will ensure that a note will use channel 8 -- and will send that note to the vsti or midi instruments channel 8.

Note velocity (1-127)

Used to change the velocity for a note or note selection to a specified value, within the range 1 to 127.

Notation

Presents a limited submenu of musical notation options – **Voice, Phase/slur, Articulation, Ornament and Note head**. These are explained in the [chapter immediately following this one](#). Notation data can be displayed in a [MIDI editor lane](#). It is selected in [the same way as other data](#) such as Velocity, Pitch, etc.

13.16 Using the Keyboard

Notes can be entered at the position of the edit cursor by using the Keyboard Shortcut **I** or at the mouse cursor by pressing **Insert**. Looking at the right click Notes menu you can see that default keyboard shortcuts have been assigned to many of these commands. There are others that are not shown on the menus. Some of the most useful of these are listed here.

The **Edit Cursor** position on the Timeline is adjusted by using any of the following Keyboard Shortcuts.

To do this use this shortcut
Move edit cursor right by one grid division.	Right or Ctrl Num 6
Move edit cursor left by one grid division.	Left or Ctrl Num 4
Move edit cursor right by one pixel.	Shift Right or Ctrl Alt Num 6
Move edit cursor left by one pixel.	Shift Left or Ctrl Alt Num 4

Notes can be **moved** using any of the following Keyboard Shortcuts.

To do this use this shortcut
Move selected note(s) down one octave.	Alt Num 2
Move selected note(s) down one semitone.	Num 2
Move selected note(s) up one octave.	Alt Num 8
Move selected note(s) up one semitone.	Num 8
Move edit cursor left by one pixel.	Alt Num 4

For a bound hard copy of the latest version of this User Guide (printed in B&W) go to LULU.com

Up and Running: A REAPER User Guide v 7.31

To do this use this shortcut
Move edit cursor left by one grid unit.	Num 4
Move edit cursor right by one pixel.	Alt Num 6
Move edit cursor right by one grid unit.	Num 6

Note display can be **filtered** for channels 1 to 10 using any of the shortcuts **Shift 1** thru **Shift 0**. **Shift `** removes the note filter and restores all notes to view.

Using F1-F12 as step sequencer:

When **Use F1-F12 as step sequencer** is selected, the keys F1 thru F12 can be used to enter notes. These keys are mapped to the 12 Semitones of an Octave, with F1 having the lowest pitch and F12 having the highest pitch. The method for using this is the same as already described under the MIDI Editor's main **Options** menu.

Note Properties:

The keyboard shortcut **Ctrl F2** can be used to open the Note Properties box, as an alternative to choosing the command from the right-click menu.

Selecting / Editing multiple Notes:

Multiple notes can be selected by holding down the Ctrl or Shift keys while selecting notes with the mouse, by drawing a Marquee (Right-click and drag) around a group of notes, or by using Select All (**Ctrl A**).

- ◆ The value of all selected notes can be adjusted by dragging one of the selected notes.
- ◆ The duration of all selected notes can be adjusted by dragging the edge of one on the selected notes.
- ◆ The note velocity of all selected notes can be adjusted by dragging the Velocity handle (when active) of one of the selected notes.

The default Velocity value for notes created in the MIDI Editor is taken from the last selected event - e.g. if the Velocity of the last selected event was 70, then the Velocity value for the next created note will be 70.

13.17 Transposing Notes

As an alternative to using the **Edit, Transpose** command to transpose MIDI notes you can use a number of keyboard shortcuts. First select the required notes, then use one of the following shortcuts:

Move notes up one octave	Alt NumPad 8
Move notes up one semitone	Ctrl Up or NumPad 8
Move notes down one octave	Alt NumPad 2
Move notes down one semitone	Ctrl Down or NumPad 2

13.18 General MIDI Program Patches

We have already seen that you can use a Bank/Program Select lane to make program changes within an item. It's worth noting that REAPER includes a file GM.reabank (in the \Application Data\REAPER\Data folder) which can be used to select standard General MIDI banks and patches. An example is shown here.

If the General MIDI banks are not automatically available in the Bank drop down list, click on the **Load File** button, navigate to the REAPER data directory and select the file **GM.reabank**.

13.19 MIDI Preview Scrub

Within Piano Roll View and Named Note View you can preview your MIDI material by clicking and dragging the edit cursor along the timeline. This is similar to audio scrub: exact scrub behavior will be determined by the settings under **Options, Preferences, Audio, Playback**.

13.20 F3 - The Panic Button

The **F3** key can be your best friend when you are working in the MIDI Editor (and also when you are playing back MIDI items in REAPER's main Arrange View). Pressing F3 will set all notes to all MIDI outputs off, until you stop and recommence playback.

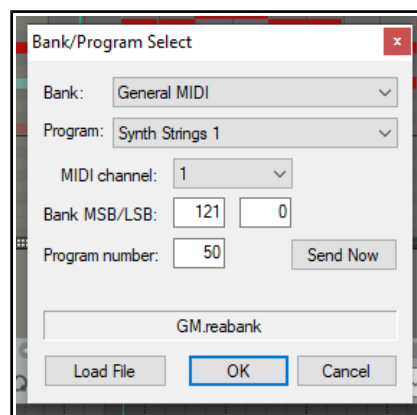

Working with MIDI Items

13.21 MIDI Editor Modes and Views

13.21.1 Note Modes

The MIDI Editor has four modes, accessible from the **Views** menu.. These are **Piano Roll** (keyboard shortcut **Alt 1**), **Named Notes** (**Alt 2**), **Event List** (**Alt 3**) and **Musical notation** (**Alt 4**). Musical notation view is covered in the chapter immediately after this one.

Up until now, the only view used in this User Guide has been Piano Roll. Before moving on to examining the other two views, there are a couple of points that you might find interesting.

Named Notes Mode:

In this mode you can double right click in the left pane to enter text, as shown. If you select the option on the View menu **Piano roll notes, Show note names on notes**, then the names will be shown on the actual notes themselves. If you leave this option enabled, the names will also be displayed in **Piano Roll View**.

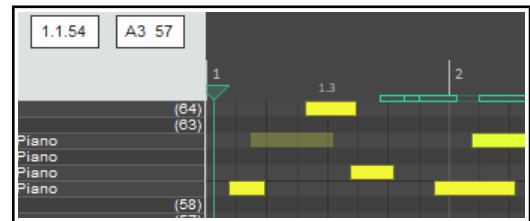

You can re-order the note rows into a custom order. Simply hold the **Control** key while dragging a piano key up or down the order.

In named note mode, you also have the options (**View** menu, **Show/hide note rows** command) to **Show all note rows**, **Hide unused note rows**, **Hide unused and unnamed note rows** and **Show custom note row view**. The first option is the default.

Hiding unused note rows can make it easier for you to navigate thru the MIDI Editor to work with existing notes (see above right). However, problems may occur if you then want to add or move notes to rows that are currently empty. The option to **Hide unused and unnamed note rows** can help you to get round this. By taking the time *before* you choose this command to name any empty rows that you are likely to need, you will ensure that these rows will still be available to you. **Custom note row view** causes the left piano roll column to display any note names that you have added or imported rather than the piano keys.

Note names can be saved to, [exported to and imported from note name files](#) from the **File** menu.

Event List Mode:

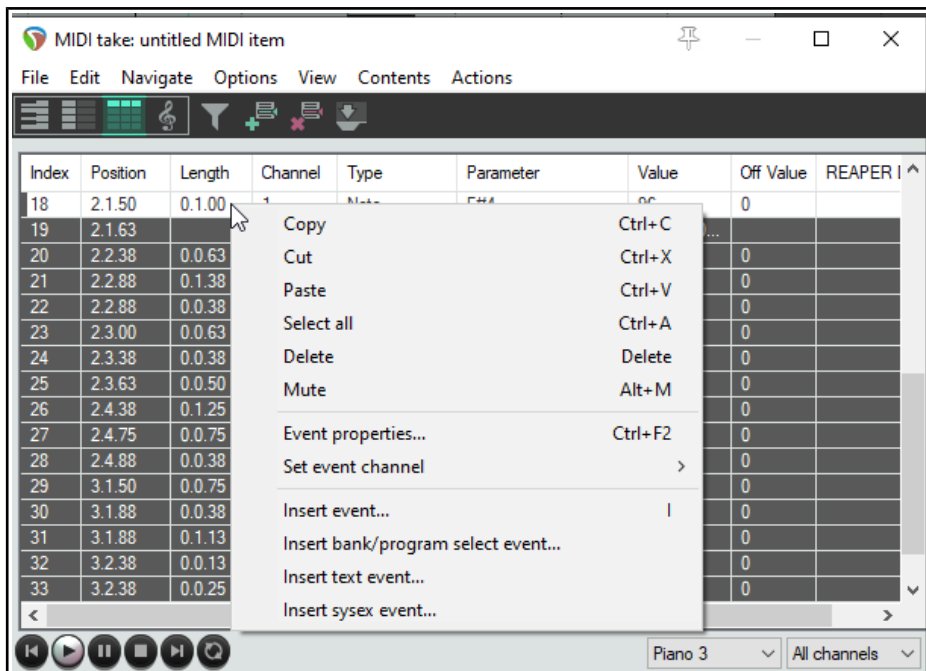

Event List mode (**View** menu) displays the MIDI information as a list of events, in tabular form.

In this mode you can use the right click menu (shown left) to i(for example) insert, copy, cut paste, delete or mute any events. The full menu is shown above.

Up and Running: A REAPER User Guide v 7.31

You can also double click on any event to modify that event's properties (see example, right). The information displayed in the Event Properties dialog box will in large measure depend on the event type of event.

The Event List view toolbar is simpler than that of the other two views. The **Filter** button is used to filter only those events that you want displayed. The **Add** button will insert a new event immediately before the currently selected event, and the **Del** button will delete the currently selected event. The last button toggles the docking of the MIDI Editor on and off.

Note: From the **Options** menu, the toggle command to **Display 14-bit MSB/LSB CC data as a single entry in event list view and event properties dialog** is by default enabled. This causes 14-bit MSB/LSB CC data to be shown as a single entry rather than separately.

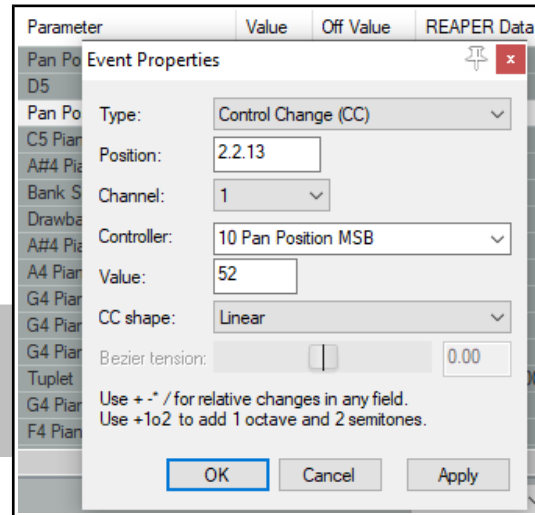

13.21.2 Note Styles

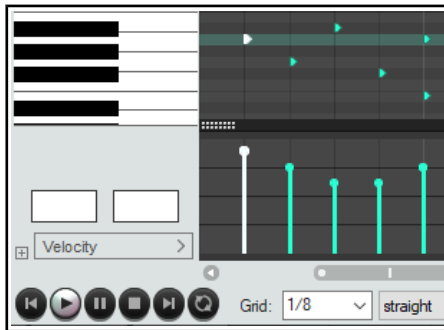

The default display note style used by the MIDI Editor is rectangular. This is the style that has been displayed in all of the Piano Roll View and Named Note View examples up to now. However, two further options are available, specifically for use with drum sounds.

These are triangle and diamond modes. To choose a note style, click on the appropriate toolbar icon, or use the **View, Piano Roll Notes** command and select **Rectangle**, **Triangle** or **Diamond**.

An example which uses triangles instead of the default rectangles is shown on the left.

13.21.3 Note Coloring Options

As briefly mentioned earlier, you have several options for how you wish to color your MIDI notes. These are accessed via the **View, Color notes by** command. By default, REAPER draws its colors from its own color map, but you can import your own if you wish. Options are **Velocity**, **Channel**, **Pitch**, **Source**, **Track**, **Media Item**, or **Voice**.

There are also options **when coloring by track or media item** whether to use theme colors for note bodies and/or borders.

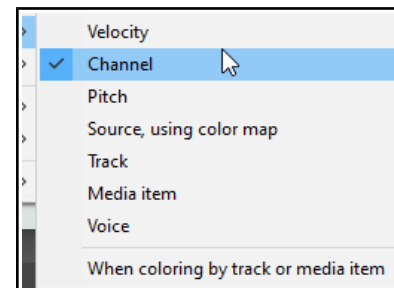

13.22 Arrange View MIDI Processing Options

Arrange view offers you a number of options for processing MIDI items as a whole (rather than working on notes or note selections). These are available by selecting **Item processing** from the right-click context menu:

Explode multichannel audio or MIDI items to new one channel items: this will create a new track and a new item for each channel that contains MIDI data. For example, if you have data on (say) channels 1, 4 and 5 this will create three separate items, one for each channel.

Explode MIDI items by note row (pitch): this will create a separate track/item for each row that contains notes.

Convert active take MIDI to .mid file reference: creates a .mid file for the track MIDI data. If you now view source properties you can confirm that this data is now stored in a .mid file.

Convert active take MIDI to in-project source data: this is the exact opposite of the previous command. It converts data currently held in a .mid file into MIDI notes, as if they had been entered directly into the MIDI Editor.

Working with MIDI Items

13.23 Quantizing MIDI Data

The term **Quantize** refers to a process of aligning a set of musical notes to a precise setting. This results in notes being set on notes and on exact fractions of notes. When you quantize a group of MIDI notes, the program moves each note to the closest point on the timing grid.

The point of quantizing is to provide a more uniform timing of sounds. It is often applied to MIDI notes created by a musical keyboard or drum machine. Quantize is available by choosing the **Edit, Quantize events** command from the MIDI Editor menu. This causes the dialog box shown on the right to be displayed.

The first choice you have is between the **Use Grid** and **Manual Settings** option. We'll come to Use Grid shortly. Shown right is the dialog box interface that appears when the Manual option is selected. The various quantize parameters are explained below.

Notice the **Bypass** option (top right). Disabled it lets you see the result of different quantize parameter settings as you tweak them. Enable this until you are finished if you don't want this to happen. Toggle it to compare how your music sounds with and without quantizing applied.

All Notes, Selected Notes, All Events or Selected Events. The first Quantize drop down list allows you to quantize selected notes or events (not just notes) or the whole sequence (all notes or all events). This can come in handy if you just need to quantize a certain off section, or perhaps just a certain instrument, such as the hi-hats of a drum section. The second Quantize drop down list works in conjunction with whatever selection you make from the first. You can choose to have the quantizing of notes and/or events applied to the **Position** only, **Position and Note End**, **Position and Note Length**, **Note End Only** or **Note Length Only**.

The **Strength** setting adjusts how strictly notes are quantized. The lower you set the strength, the less 'magnetism' the grid has to the midi notes. This introduces subtle imprecisions to the quantizing which can make the outcome seem less clinical.

The **Grid** and **Length** values determine which units (measured as fractions of a note) are used for quantizing. These can be selected from the drop down lists or entered manually in their respective boxes. They act in conjunction with the **Allow notes to** options (see below). Grid type can be straight, triplet, dotted or swing. If swing is selected, you will also need to specify swing strength.

Move left and **Move right.** If Quantize Position is enabled, these will ensure that notes are individually quantized to the start or end of the specified note fraction, whichever is nearest. Move left only will only quantize notes to the start, move right only will only quantize notes to the end.

Shrink and **Grow.** These are applied if Quantize Length is enabled. REAPER will extend or shorten notes by moving the end position of each note. You can enable either or both of these options.

The **Only quantize range** faders let you specify a percentage range for quantizing. 50% represents the mid-point between the grid lines. Values more than 50% are only really meaningful if "allow move right" or "allow move left" is disabled. The distance is measured from the grid line being quantized: normally it will select the closest line so that you will never be more than 50% away.

Fix Overlaps can be enabled to stop notes from overlapping as a result of being quantized.

When the **Use Grid** Setting is selected, the Quantize Events dialog box will be as shown on the right.

From the **Grid** drop-down list (at the bottom of the MIDI Editor window, next to the transport bar), select a note length value (such as 1/32, 1/16 or 1/8) and then select an item from the **grid spacing type** list. This can be straight, triplet, dotted or swing. If you choose **Swing** a

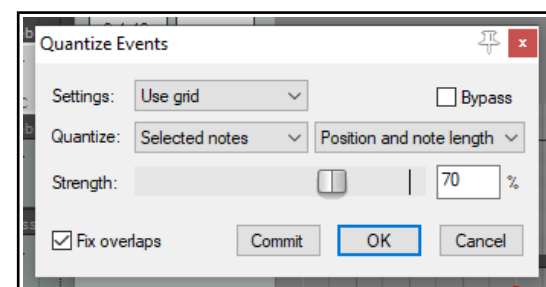
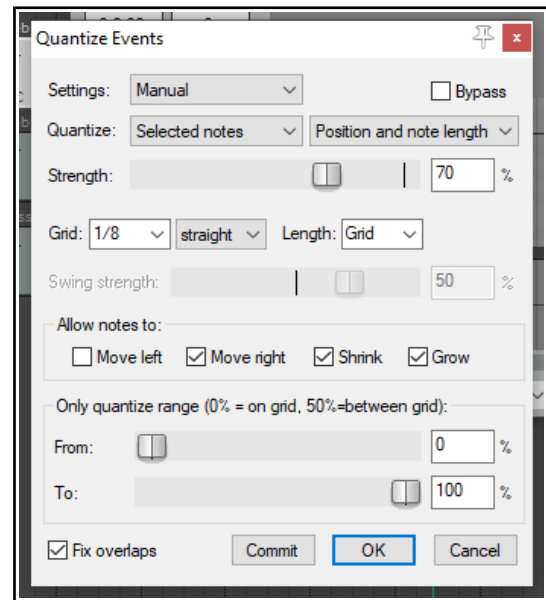

Up and Running: A REAPER User Guide v 7.31

strength fader is displayed (see above). This is used to adjust the swing setting within a range of -100% to 100%, or you can enter a value directly into the **Swing %** edit box to its immediate right. You should also set a **Notes** value: left at Grid, this will take its value from whatever is chosen for the grid. Otherwise you may select any other required value from the drop down list.

Used well, swing can result in a more musically pleasing output.



In essence, you define a

percentage delay to be applied on the upbeat. For example, if you apply swing to 1/4 notes then those which coincide with the 1/2 note divisions will be unaffected by the swing, those that fall between these divisions will be delayed by the amount specified. Small amounts of swing (even 5% or less) can help to prevent a part from sounding too rigid.

Quantize is non-destructive – that is to say, the process can be reversed at any time. The various other commands on the **Edit** menu that are used with quantizing are:

Quantize notes using last settings

This bypasses the **Quantize Events** dialog box, making it easier for you to apply the same quantization settings to various disparate selections.

Quantize notes position to grid

This quantizes notes according to your grid settings.

Unquantize events

Removes quantization and returns the notes to their previous state.

Freeze quantization for events

Freezes the quantization for all currently selected events.

Shown above is an example. The top picture shows two unquantized notes selected. In the second picture they are quantized by moving them left. In the third picture, they are quantized by moving them to the right.

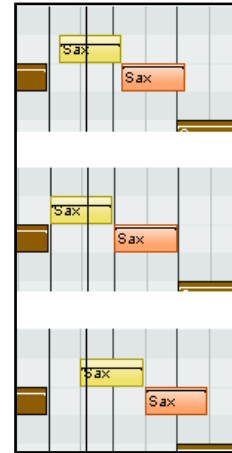

More **quantize** options are available in the MIDI Editor **Action List**, including actions to quantize note positions to specific divisions, ranging from 1/4 down to 1/64.

13.24 Input Quantization

Input Quantization is a process by which MIDI notes are automatically quantized as they are entered. This could be, for example, by playing your MIDI keyboard, or the [REAPER Virtual Keyboard](#).

Input quantization is applied on a per track basis. Right click on a track's red record arm button (TCP or MCP) or on its record options button (TCP) and choose **Track Recording Settings** from the menu. The dialog box shown on the right will be displayed.

Select the option to **Quantize track MIDI recording**. Options then available include:

- The note length to be used for quantization (e.g. 1/8).
- Quantize positioning preference. Options are **Nearest value**, **Previous value** and **Next value**.
- Whether to quantize note-offs.
- Quantization strength. A lower setting will allow more subtle variation, creating a more "human" effect by allowing minor variations in how strictly the quantization is applied.
- Swing setting. This can be between 0% and 100%. You can use this setting to add a touch of delay to those notes that do not fall on the upbeat. The best way to understand how these settings affect how your notes sound is to try a few examples.

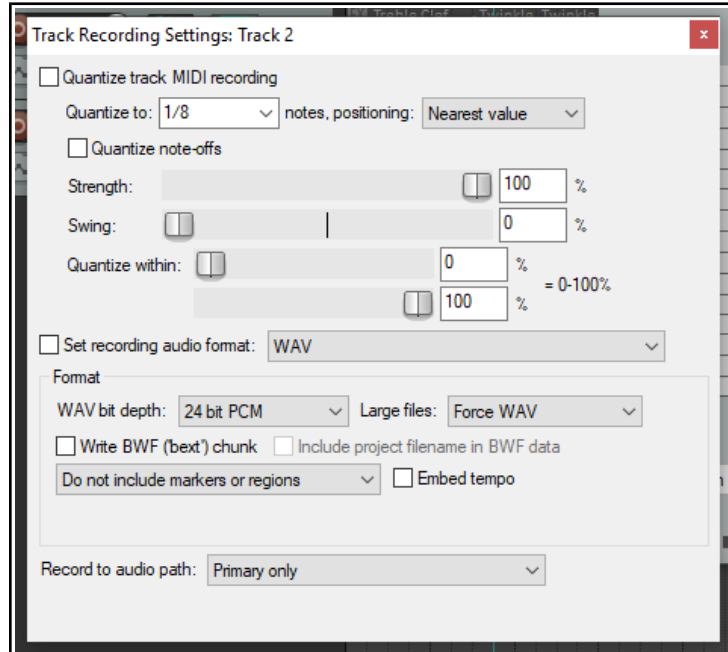

Working with MIDI Items

- Quantize within % range. These are similar to the Nearly Quantized and Far From Quantized faders in the Quantize Events dialog box (see previous section).

In addition, the **Main (alt Recording)** section of the **Action List** includes actions to:

- Toggle MIDI input quantize for all tracks, selected tracks, or last touched track.
- Enable or disable MIDI input quantize for all tracks, selected tracks, or last touched track.

13.25 Humanize Notes

Humanize Notes (from the Edit menu) can be used to introduce subtle variations – some might say imperfections! – to a MIDI item that is just too exact, too perfect. For example, no human pianist will ever complete an entire live performance on an acoustic piano with every key being struck with exact precision and perfect timing. Therefore, you might not want your MIDI items to be too perfect.

The **Humanize Notes** dialog box (right) can be used to introduced random variations in timing and velocity to an existing MIDI item to make it sound ... well, more human!

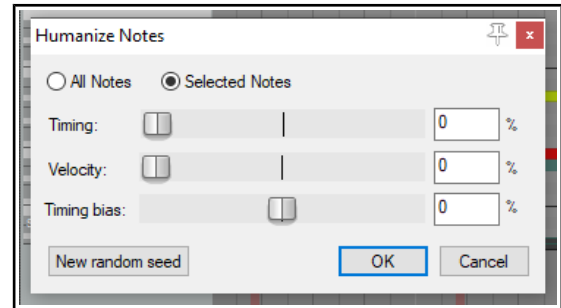

13.26 Step Recording

Step recording is a method of recording a sequence of MIDI notes within REAPER's MIDI Editor, one step at a time. In overview, you start by choosing a step size (such as a quarter or eighth note), then play your notes using a MIDI keyboard or the function keys F1 to F12. Each note you play is recorded and the insertion point is moved into position ready for the next note. You can then continue, playing more notes as you wish. You can also, if you wish, change the note size while recording. Let's see how this is done:

1. From REAPER's main menu, choose **Insert, Virtual Instrument on new track**. Select your instrument and click **OK**. The track will be inserted armed for recording, with input monitoring on.
2. Display the **Input** drop down list for this track and select a MIDI channel (or All channels) for your MIDI keyboard.
3. Click and drag in the arrange area to define the length of your required MIDI item. From the menu, choose **Insert, New MIDI item** to insert the item.
4. Open the item in the MIDI Editor. Double-click on item will do this, or you can choose **Open in built-**

in MIDI

editor
from the
right-click
context
menu.

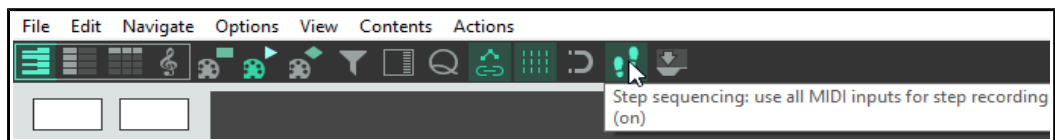

5. If you are using a keyboard, enable step recording either by choosing **Use all MIDI inputs for step recording** from the MIDI Editor Options menu, or by clicking on the equivalent toolbar button.
6. If you wish to **Use F1 - F12 for step recording**, enable this menu option. These keys are then mapped to the 12 semitones of an octave. In this example, we'll use these keys. Remember, however, you could use a MIDI keyboard if you have one.
7. Select a note length (e.g. 1/4, 1/8) from the drop down list next to the MIDI Editor's transport bar.
8. In the piano roll keyboard, select a note (e.g. C4). This note will now be represented by F1, with subsequent function keys moving up the scale to higher notes. Press function keys as required to enter notes and to advance the cursor according to snap settings (hold Shift if you wish for snap settings to be ignored). These notes can be edited like any others, for example to adjust velocity.
9. Selecting a different note in the MIDI editor keyboard will reset the value of F1 (and all other function keys accordingly).

These instructions represent the essentials of step recording. Depending on which virtual instrument you use, and on your MIDI keyboard setup, you might need to "tweak" them to suit your exact requirements.

13.27 Working with Multiple MIDI Tracks and/or Items (Overview)

From Arrange view by choosing the command **Open in built-in MIDI editor** (right click context menu) will make MIDI items available for editing. This offers four mutually exclusive options – **Open clicked MIDI item only**, **Open all selected MIDI items**, **Open all MIDI on same track**, and **Open all MIDI in project**. You can set a default option in the [Editing Preferences, MIDI Editor](#) page of REAPER's preferences (see Chapter 22).

Double-clicking on the item opens the MIDI Editor according to your preferences. For example, if you set your preference to one MIDI editor per media item, then each MIDI item you double-click on will open in a separate MIDI editor instance. If set to one MIDI editor per project then all MIDI items being opened in the MIDI editor when any single MIDI item is double-clicked: The double-clicked item will be the selected and active item.

If **All MIDI in the project** is specified you should also specify whether to open the clicked MIDI item only, all selected MIDI items, all MIDI items on the same track, or all MIDI items in the project (see right).

Within the MIDI Editor, your default preference settings can be overridden on a per project basis from the **Contents** menu. This will be discussed shortly.

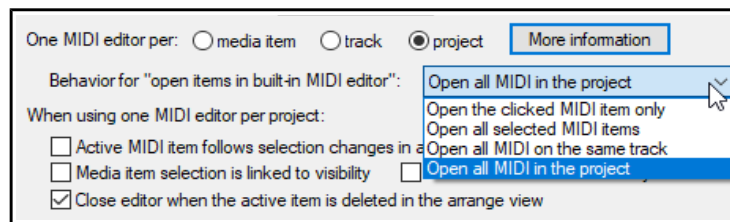

Tracks and items can be managed by displaying the **Media Item Lane** (second button on toolbar toggles) and the **Track List** (first button on toolbar toggles). Both these options are also available on the **Contents** menu.

The illustration below shows an example of the MIDI Editor window opened with four MIDI tracks, some of which include several items. Both the Track List (right of window) and the Media Item Pane are displayed.

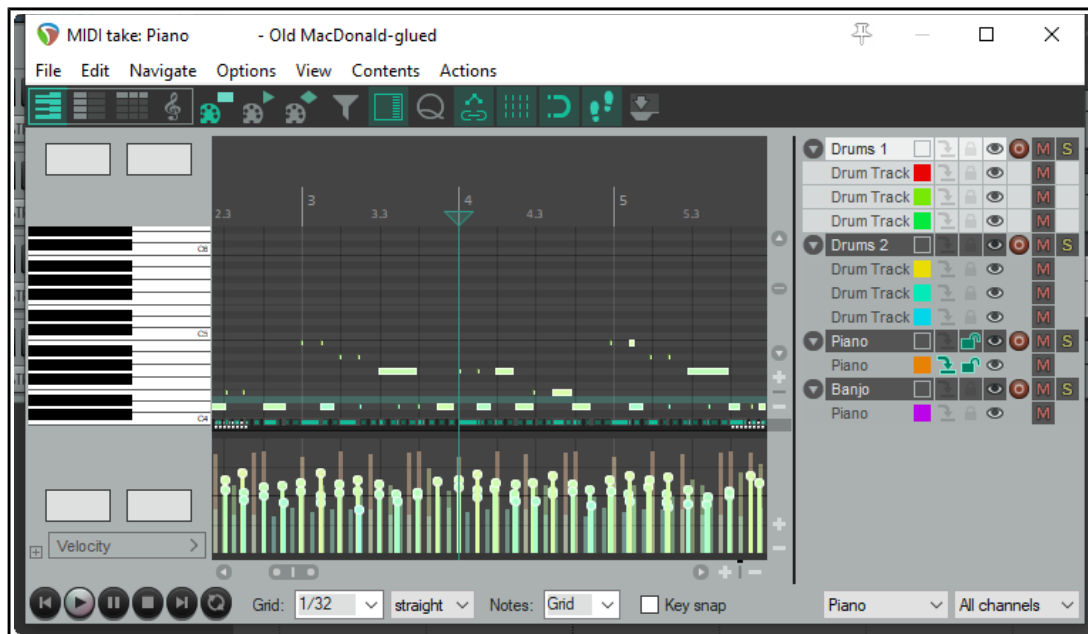

In the MIDI Editor Contents Track List each item is assigned three qualities – active status, editability status, and visibility status, These can be set as required to allow you to work with different items at different times.

Active means that the item can be used for inserting, copying, pasting notes, etc.

Editable means that mouse edits (move, lengthen, etc.) and commands such as quantize, transpose and humanize can be performed on an item's notes. One and only one item at a time may be active, but as many items as you wish may at any time be visible and/or editable.

Visible means the item and its notes are displayed in the MIDI editor window.

Note that:

- An item can be visible without having to be editable or active. One or more items may be visible.
- An editable item will also be visible but need not be active. One or more items may be editable.

Working with MIDI Items

- An active item will also be editable and visible. One and only one item is active at any time.

Any track or combination of tracks can be made active using the “eye” column in the track list (see above right). A track can be made active by selecting it in the track list, or from the **Contents** menu, or using the drop down list near the end of the transport bar (see right). If the track contains only one MIDI item, that item will be made active. If it contains more than one item, all items will be visible and editable but only one item will be active.



The **Filter Events** window (accessed from the toolbar) allows you to select multiple channels for display and editing. If you select two or more channels in this window, the drop down channel list at the foot of the MIDI editor window will read “Multichannel” or “All channels”. Alternately, you can simply use the drop down channel list to select “All.”

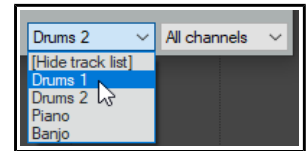

The **MIDI** column in the **Track Manager** (Chapter 12) can also be used to open items in/remove items from the MIDI Editor, and to show items in/hide items from the MIDI Editor track list. Tracks can also be selected to be shown in or hidden from the track list using the track list’s context menu.

13.28 Managing Multiple MIDI Tracks and Items

The Track List

Track List display is toggled on and off by the Track List icon on the MIDI Editor toolbar, or from the **Contents** menu. Right-click on the track list area to open the Track List context menu (shown here). If you need to override the preferences default setting, you can specify whether you want **One MIDI editor per media item, track, or project**.

Behavior for “open items in built-in MIDI editor” options are to open **Clicked item only**, **All selected MIDI items**, **All MIDI items on same track as clicked item** or **All MIDI in project**. These options are also found on the MIDI editor **Contents** menu.

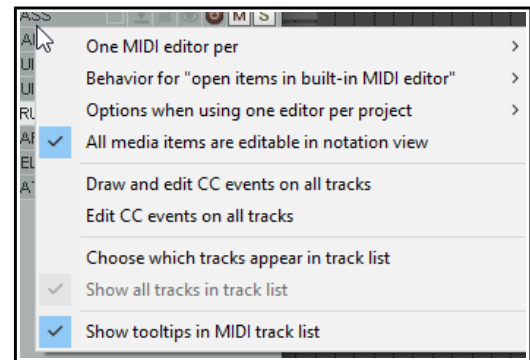

Two mutually exclusive options from the MIDI Editor **Options** menu are repeated here: these are **Draw and edit CC events on all tracks** and **Edit CC events on all tracks**. You can enable neither or one of these at a time, but not both.

You can run the action **Choose which tracks appear in track list** to hide tracks from or restore them to the track list. Selecting this command causes the **X** symbol to be displayed beside each track name. This toggles track display. In its default gray state, the track is marked for display, when red it will be marked to be hidden.



After making your selection, again select **Choose which tracks appear in track list** from the context menu to implement this selection. Those tracks marked with a red **X** will now be hidden. The command **Show all tracks in track list** will restore them to view. Also, you can choose whether to **Show tooltips in MIDI track list**.

The **Options when using one MIDI editor per project** command (also on the MIDI editor **Contents** menu) includes further ways in which you can specify MIDI Editor behavior when selecting and editing items:

Item selection toggle commands are **Active MIDI item follows selection changes in arrange view**, **Selection is linked to visibility** and **Selection is linked to editability**. Select any, all or none of these.

If both selection link options are set to off, then all items displayed in the piano roll can be edited.

However If item selection is linked to visibility, items which are visible but not editable will be displayed in the piano roll window but cannot be edited (e.g. moved or deleted).

If item selection is set to editability, then those items defined as editable will be displayed and can also be edited. Items defined only as visible will be displayed but cannot be edited.

- Item editing toggle options are **Only MIDI items on the same track as the active item are editable** and **Close editor when active MIDI item is deleted in arrange view**. Enable both or neither of these.

Up and Running: A REAPER User Guide v 7.31

In the example shown here (below) three tracks are listed and displayed, containing in total seven MIDI items. The Piano and Bass tracks holds three items each. The Flute just one item.

- The symbol that contains an arrow (to the left of each track name) opens and closes a list of MIDI items on that track.
- This track list operates in a similar fashion as the arrange view track list. Click on an item name to select it, or on a track name to select all items on that track. You can use control+click or shift+click to build a selection. The first item in a built selection will be made active, but you can also click on the “make active” icon of other items. You can use the various other icons to set qualities such as icon color, solo, mute or editability for the entire selection. The small colored square to the right of an item name opens the color picker: this can be used to select a different color to be used for this item in the Media Item Lane.
- The column to the right of the color picker is the “make active” column. Click here to make any item current for inserting events (shown by the green arrow). It will then also be made editable and visible.
- Click in the next column to the right of this to make any item visible and editable, indicated by the green unlocked padlock icon. If contents do not appear visible, check 1) the scroll settings for the MIDI editor window, and 2) the channel filter, to ensure that the required channel is included in the filter. This same green icon can then be used to toggle editability.
- The eye symbol to the right of this toggles the visibility of any item (or item selection) in the MIDI Editor. The gray/red circle to the right of this (for tracks) toggles record arm status for that track. This is used in conjunction with the Record button on the Arrange view Transport Bar.
- Use the **M** button to the right of this to toggle mute status for individual tracks or items. Use the **S** button to the right of this to toggle solo status for any track.



13.28.1 The Media Item Lane

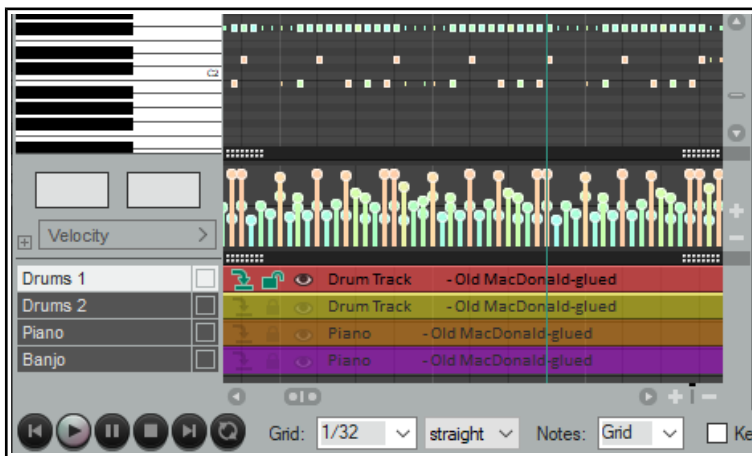

The media item lane (**Contents** menu) displays the MIDI items and their position in the arrangement. Clicking on any item highlights, selects it but does not make it active. As with the track list, you can use control+click or shift+click to build a selection. The individual media item right-click context menu offers you various options for setting items to custom colors or random colors.

The Media Item Lane duplicates most of the features of the Track List, including the color picker, target, padlock and eye icons.

The Contents menu also includes (at the bottom) a list of MIDI items that are currently open. Selecting any item from this menu makes it active and displays its contents in the piano roll window.

13.29 Optimizing MIDI Editor Workflow

Working in REAPER’s MIDI Editor can be quite a challenge, especially for the newcomer faced with a projects that contain multiple MIDI tracks and items. Happily, Seventh Sam has produced an excellent free guide **How to Set Up REAPER’s MIDI Editor for Better Workflow** which is available at:

<https://seventhsam.com/guides/blog/6791049/how-to-set-up-reaper-s-midi-editor-for-better-workflow>

13.30 Editing Multiple MIDI Items

In order to be able to edit different MIDI items at the same time you will first need to select those items that you wish to make available for editing, as explained in the previous section. You can then perform normal mouse editing activities on any part of the selection, such as copying or moving, adjusting velocity, stretching, shrinking, etc. The table below gives some examples of how you can apply this to various MIDI editing tasks.

Working with MIDI Items

If you want to do this do this!
Change track/item name.	Double-click on name in track list and edit.
Copy/move a note (or note selection) to another item within MIDI editor.	Make sure source item(s) editable. Select note(s), press Ctrl C (copy) or Ctrl X (cut). Make the destination item active. If required, position play cursor. Press Ctrl V (paste).
Copy/move a note (or note selection) to another item in Arrange view.	Make source item(s) editable in MIDI Editor. Select note(s), press Ctrl C (copy) or Ctrl X (cut). Select destination item in Arrange view, make it active in MIDI Editor, position play cursor. Press Ctrl V (paste).
Mouse edit a selection of notes in more than one MIDI item.	Make items editable. Select notes and use mouse (e.g. drag to move, click drag from edge of any note to lengthen or shorten notes).
Delete selection of notes across more than one item.	Make items editable. Select notes and press Delete key.
Mute/Unmute note selection across more than one item.	Make items editable. Select notes and press Alt M , or use Mute events command from Edit menu.
Change note properties for a selection of notes	Make items editable. Select notes and press Ctrl F2 . Make changes then OK .
Quantize, Humanize, Transpose across multiple items.	Make all required items editable. Make note selection and choose Edit menu command, e.g. Quantize, Humanize, Transpose.
Adjust velocity of notes selected in two or more items.	Display velocity lane and make items editable. Select required notes. Click/drag mouse up/down from top edge to increase/decrease velocity.
Edit CC data across multiple MIDI items.	Display CC lane and make items editable. Select required events and perform edit as required with mouse or via Event Properties dialog.
Show/Hide all MIDI items on tracks in Track List.	Click (for one track) or Shift click (for all tracks) on diamond symbol to the left of any track name in Track List (toggle).
Show/Hide all tracks/MIDI items in Track Folder.	Click on circle symbol to left of folder name in Track List (toggle).

MIDI Editing with Multiple Items: Some Tips and Examples

These notes assume that you are by now familiar with the basic MIDI editor navigation and editing techniques explained earlier in this chapter and, for example, shown in the exercise in section 13.26. Indeed, you are advised not to experiment with editing multiple MIDI items until you are confident that you have mastered the techniques for editing the contents of a single MIDI item.

13.31 MIDI Editor Mouse Modifiers

The Mouse Modifier dialog is opened by the **Options, MIDI editor mouse modifiers** command. Here you can customize exactly how you would like the mouse to behave when you are working in the MIDI editor.

There are several areas in which you can modify mouse behavior within the MIDI Editor. These include **MIDI note**, **MIDI note edge**, **MIDI CC lane**, **MIDI CC event**, **MIDI Source loop and marker**, **MIDI ruler**, **MIDI marker/ region lanes**, **MIDI piano roll** and **MIDI editor**. In many cases, separate contexts are available for left click, left drag and double-click behaviors. For example, if you wanted to, you could ensure that, say, **Shift Alt Left click** is used to toggle a note's mute status.

For much more about [mouse modifiers](#), including MIDI Editor mouse modifiers, see [Chapter 14](#) and [Chapter 15](#).

13.32 MIDI Editor Actions

REAPER's Action list Editor lets you assign [keyboard shortcuts](#) to any command or action, or [sequence of actions](#), including many not shown on the MIDI Editor menus. Chapter 15 will show you how to do this, including [adding actions to the MIDI Editor menus](#).

Up and Running: A REAPER User Guide v 7.31

The Action list is displayed by choosing **Show actions list** from the **Actions** menu. One of the first things to notice about it is that it contains a whole load of assignable actions beyond those that are shown on REAPER's menus. This means that you are able to create your own keyboard shortcuts for any of these actions, and even for sequences of actions.

Notice also (below right) that when using the MIDI Editor Action List, you are able to assign MIDI commands and actions to keystrokes so that those keys will behave differently in the MIDI Editor from the way they behave in the main REAPER environment. You can see that there's quite a few, and that some already have keys assigned to them. You can assign your own keys to other actions.

Let's take a simple example. Being able to select notes quickly and easily is important when you are working with the MIDI editor.

If in the Action List filter box you type (for example) **add note** then only those actions which included these characters will be displayed (see right). One of these is **Add next note to selection**. You can assign a shortcut to this action.

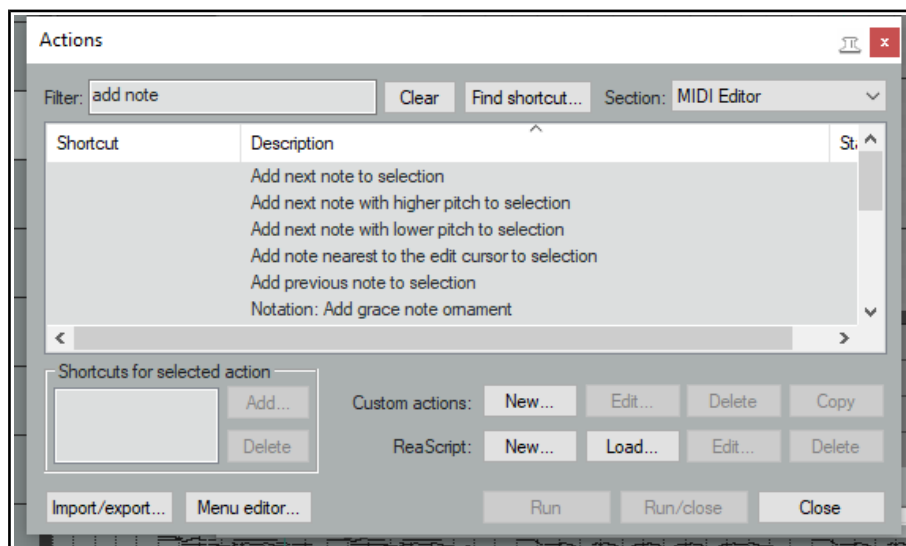

You'll see in [Chapter 15](#) that the Actions List Editor lets you do much more than this. For example, you can:

- Chain together any sequence of actions so that the sequence can be executed with a single keystroke.
- Add actions and custom actions to your MIDI Editor toolbar and/or the MIDI editor Actions menu, and/or any of REAPER's MIDI Editor menu commands (File, Edit, Navigate, Options, etc.)
- REAPER's MIDI Editor commands (such as Edit -> Delete events, Edit -> Insert note, Edit -> Quantize, Navigate -> Select next note, Options -> Correct overlapping notes when editing, etc.) can all be found in the Action list. In addition there are many hundreds of actions, some very precise, which are not shown on the menus. The table that follows should help guide you thru many of these.

Category/Group	Examples of MIDI Editor assignable actions(not fully comprehensive)
Note/event selection	Select all notes with same value, note nearest to edit cursor, all muted notes. Add next/previous note to selection, Add note nearest edit cursor to selection. Select/unselect all CC events, Select/unselect all CC events in last clicked lane. Select all notes in time selection, Select all notes starting in time selection, Select all CC events in time selection (several variations).
Activate item/track	Activate next/next visible/previous/previous visible MIDI item. Activate next/next visible/previous/previous visible MIDI track (if multiple items/tracks are open).
CC lane management	Next/previous CC lane. Set CC lane to <i>parameter</i> . Set CC shape to xx. Set default cc shape to xx.
Channel display	Show only channel xx, Show only next/previous channel, Toggle channel xx, Color notes/CC by channel, Allow CC shape in sustain lane.
Grid actions	Set grid type (straight, dotted, triplet, swing). Adjust swing grid strength.
Navigation	Actions to navigate by channel, voice, pitch (all views) or staff (notation editor).

Working with MIDI Items

Category/Group	Examples of MIDI Editor assignable actions(not fully comprehensive)
Remove duplicates	Separate actions to remove duplicate notes only/all duplicate events.
Note coloring / inserting / editing/ manipulating / moving/ transposing	Color notes by velocity/channel/media item custom color/using colormap/by track custom color. Delete all notes/trailing notes less than [1/128 to 1/8] note in length. Lengthen/shorten one grid unit/one pixel. Make notes legato, preserving note start times/relative note spacing. Move notes down/up one octave/semitone (transpose) Move notes left/right one grid unit/one pixel. Invert selected/all notes, Reverse selected/all notes, Invert chord voicings. Edit note velocity +/- 01/10. Set note length to grid size/double/half, Set length for next inserted note to grid. Trim left/right edge of notes to edit cursor. Insert note [1/128 to 1] note length. Set note length to [1/128 to 1] Set note ends to start of next note. Set note position to edit cursor. Split notes on grid. Copy/cut/duplicate notes within time selection, Fit notes to time selection. Paste events into active media item regardless of source media item (<i>allows items to be copied from a selection of media items into a single media item.</i>).
Loop/time selection	Loop point: set start/end point. Remove loop point. Double/halve loop length. Set time selection to selected notes, Remove (unselect) time selection, Remove (unselect) time/loop point selection. Move cursor to start/end of loop/time selection.
Cursor movement	Cursor advance [1/128 to 1]. Cursor advance [1/32T to 1/4T]. Move cursor left/right one measure, To start/end of current measure. Move edit cursor left/right by grid.
Lyric events	Align lyric events with notes. Import lyrics for selected notes from file. Insert/edit text/lyric event at first selected note. Select next/previous lyric event. Shift lyric events backward/forward one note.
Mouse modifiers	Actions are available to set mouse modifier behavior within the MIDI Editor for each of the categories CC event left drag, CC lane left drag, MIDI editor right drag, note edge left drag, note left click, note left drag, piano roll left click, piano roll left drag, ruler left click and ruler left drag. The list of actions is exhaustive.
Playback	Chase MIDI note-on/CC/PC/pitch in project playback (toggle).
Project sync actions	Timebase: sync to arrange view – <i>syncs midi editor timebase to arrange view.</i> Timebase: toggle sync to arrange view – <i>sets sync on/off.</i>
Toolbar management	Options in MIDI Actions List to open custom MIDI toolbars 1-16.

13.33 MIDI Output Direct to an External Synth

The MIDI output of any track selection can be sent directly to an external hardware synthesizer instead of (or as well as) to the master. From the track's right-click ROUTE button menu, choose MIDI output, then the device name, then the channels. Optionally, you may also disable output to the master send.

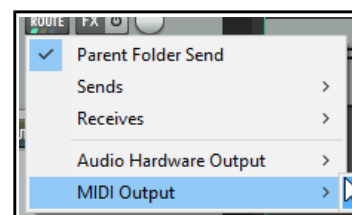

13.34 In-Line MIDI Editing

To use the in-line editor on any MIDI item, first select the item then either use the default shortcut key **E** or right click and from the menu choose **Open items in editor** then **Open in in-line editor**. The in-line editor will only be displayed if there is sufficient track height.

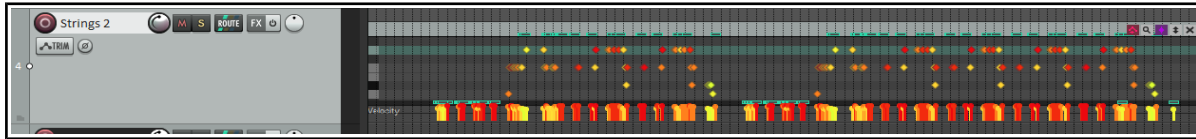

REAPER's main MIDI Editor is recommended for serious and in-depth editing of your MIDI items. However, many common tasks can be carried out using the in-line editor if you prefer. This allows you to edit the MIDI item without leaving the main window.

The in-line editor displays piano roll view only, and the contents of CC lanes will be determined by whichever lanes were selected last time the item was opened in the MIDI Editor. If it has never been opened in the MIDI Editor, the Velocity lane will be selected by default. You can adjust the boundary between the editing area and the CC lane with the mouse to adjust its height, just as in the MIDI Editor.

Right-clicking over the editing area opens a menu showing which editing tasks can be carried out with the in-line editor. In summary, the following types of commands and actions are supported within the in-line MIDI editor:

- Note editing mouse actions, including change length, change velocity, marquee, move, delete and insert.
- Most commands on the MIDI Editor's Edit and View menus, including quantize and humanize.

When working with the in-line editor, any keyboard shortcuts and custom actions that you have defined in the main MIDI Editor will apply, along with any defaults. For example, **PageUp** and **PageDown** will zoom vertically in and out within the in-line editor. You can run your MIDI Editor custom actions within the in-line editor. The in-line editor also displays a small toolbar in its top right corner. From left to right, the function of these tools is:

- The **Move CC with events** toggle tool: serves the same purpose as its equivalent tool in the MIDI Editor window.
- The **Show/Hide** tool (magnifying glass): toggles between **Show all note rows**, **Hide unused and unnamed note rows**, **Hide unused note rows** and **Custom note row view**.
- The **Item Style** tool: toggles between rectangle, triangle and diamond note display.
- The **Vertical Scroll/Zoom** tool. Click and hold on this and drag vertically up or down to scroll vertically up and down, left and right to zoom vertically in and out (see example, right). You can double-click on this button to zoom to contents.
- The **X** tool. This closes the in-line editor and restores normal display.



The MIDI Editor and In-line Editor are designed for editing your MIDI *events*. Remember also that many of the *item* editing tasks, functions and activities that you discovered in Chapter 7 can also be applied to MIDI *items* as a whole. For example, in arrange view items can be dragged and dropped, split, copied, muted, grouped in selection sets, locked and so on. Plug-ins can be added directly to an item's FX chain. Selecting a MIDI item in Arrange view and pressing **F2** will display its Item Properties window where you can shift pitch, change play rate, loop enable/disable, and do much more.

13.35 Copying MIDI Items in Arrange View

When you make a copy of a MIDI item in arrange view, then depending on your preferences and on how you make the copy one of two outcomes will occur:

The first of these is that the new item will be created as a new instance of the original item, and will use the same source data as the original. In this case, any changes made to either item will be applied to the source data, and therefore also to the other item. This might be what you want, for example, if you have a melody, a bass line, or a drum pattern that you wish to repeat throughout a project. You're still working on the line, and you may need at some future time to make changes to these items, and you wish to do this in such a way that when you make these changes to any one item they will automatically be applied to all of the others.

In the alternative scenario, the new MIDI item becomes a discrete item in its own right, so that you can independently edit either item without affecting the other.

Working with MIDI Items

By default, when you copy and paste items using the menus or keyboard shortcuts (such as **Ctrl Shift C** and **Ctrl V**), the former method (with common source data) is applied. The items are also added to the [Project Media Bay](#) (see [Chapter 12](#)) where they are listed as MIDI pool items.

To change this default behavior, disable the preference (under [Options, Preferences, Media, MIDI](#)) to **Pool MIDI source data when pasting or duplicating media items** (see also [Chapter 22](#)). Items will then by default be copied as discrete items. Note that a new MIDI pool item is never created when an existing MIDI item is split. Note

also that by default MIDI items added to a project from the Project Media Bay are not pooled. The default behavior when you copy an item by dragging with the mouse depends on your mouse modifier settings for the context **Media item drag**.

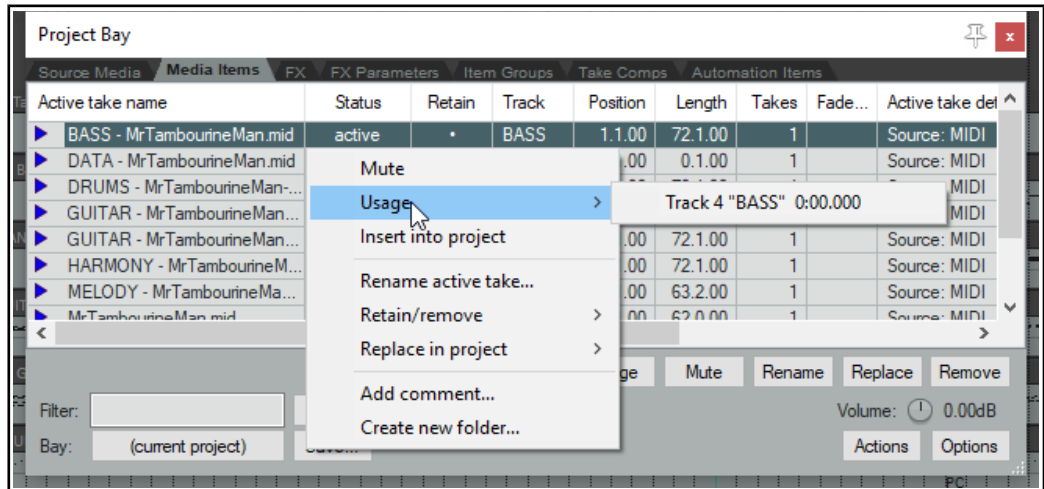

By default, the following apply when dragging MIDI items:

- Drag and drop** Move item ignoring time selection
- Ctrl with drag and drop** Copy item as discrete item
- Shift Ctrl Alt with drag and drop** Copy item, pooling MIDI source data.

For a complete list of mouse modifiers, see the [Editing Behavior, Mouse Modifiers](#) page of your Preferences. Select **Media item left drag** from the context list. You can change any assignments if you wish. The [method is explained](#) in [Chapter 15](#).



You can remove any individual MIDI item's pooled status and convert it into a discrete item. To do this, either display the item's source properties window (**Ctrl F2** or use the context menu) and click on **Un-pool this item**, or click on the item's pooled status icon (see above).

13.36 Joining MIDI Items

There may be times when you wish to join a number of MIDI items together. This might, for example, be to create a single loop enabled item, or simply so that you can edit them as one item, or perhaps to be able to export the MIDI data as a single MIDI file. For example, you might have several MIDI items that you wish to export together as a single file. The track shown below might be an example of this.

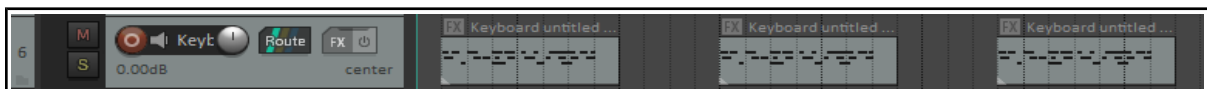

You can select all of the items (right-click and drag is often the easiest way to do this) and glue them together: right-click anywhere on the selection and choose **Glue items** from the context menu.



You can then double-click on the glued item to open the MIDI Editor, from where you can export it as a single MIDI file (**File, Export to new MIDI file ...**).

13.37 MIDI Preferences Settings

To specify MIDI preferences, choose the **Options, Preferences** command (**Ctrl P**) and then select the **Media, MIDI** page. You'll find these shown in detail in Chapter 22, but for now note that you can:

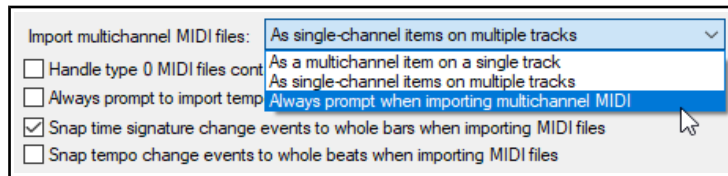

- Specify whether by default new MIDI items are created as REAPER media items (the default) or .MID files.
- Specify how your edits to imported .MID files are to be interpreted – that is, whether to apply your edits only to the item in the REAPER project file or also to the original file on your disk.
- Set the default behavior for imported multichannel MIDI files – as multichannel on a single track, as single-channel items on multiple tracks, or always prompt to ask.

Using in project MIDI items (rather than separate .MID files) for your MIDI items bestows some important advantages. For example, you can use your undo history to readily undo MIDI editing actions. You can also save different versions of the same project with different MIDI arrangements. Overdub/replace recording will not work correctly with .MID files.

13.38 Exporting Project MIDI

From Arrange view, the **File, Export Project MIDI ...** command can be used to export either an entire MIDI project or selected items or tracks, or a time selection within that project (all or selected items) to a single MIDI file. If no time selection is made, data will be exported for the entire timeline.

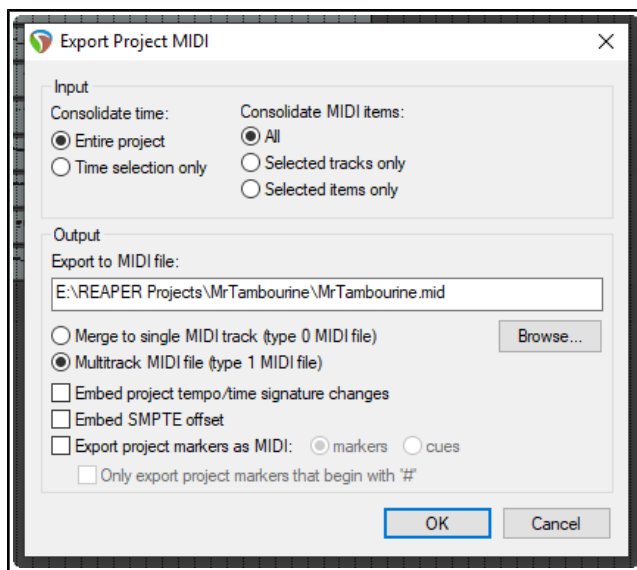

An example of such a project file is shown here. It includes six tracks with MIDI events (a different channel for each track), enclosed in a folder whose FX chain includes a virtual instrument. For the most part, the options shown here require little explanation.

You can choose to export the **Entire project** time or the current **Time selection only**.

You can include **All** media items, or **Selected tracks only** or **Selected items only**. In the example shown, **All** MIDI items has been chosen.

You can merge MIDI tracks to a **single MIDI track** as a type 0 file or export it as a **Multitrack MIDI file**, with the integrity of the different tracks maintained in the type 1 file.

You also have options to **Embed project tempo/time signature changes** and/or **Embed SMPTE offset** and/or **Export project markers as MIDI markers or cues**. This includes an option to

Only export project markers that begin with #.

13.39 MIDI Routing, MIDI Buses and ReWire

REAPER's track routing capabilities includes the use of MIDI buses. Your MIDI tracks can use up to 256 MIDI buses, each comprising 16 MIDI channels. When sending MIDI data from one track to another, you can specify the bus/channel combinations for both source and destination tracks (rather than just a channel). See the section [MIDI Routing: Track Sends and MIDI Buses](#).

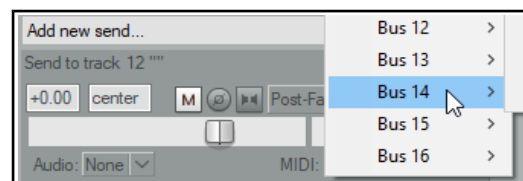

These options are available in the drop down lists in the track's routing windows.

Plug-ins can receive MIDI on a specified MIDI Bus and transmit MIDI on a specified (different) MIDI Bus.

MIDI data sent from one track to another in this way can be directly routed to any VST or AU synth in that track's FX chain: right-click over the plug-in's "In/Out" button and choose the required MIDI Bus from the MIDI

Working with MIDI Items

Input menu (below).

The same context menu can also be used to assign MIDI output from that plug-in to any bus, and/or to assign the synth's audio input or output to any track channel or channels.

When a track FX chain includes volume and pan MIDI controls (e.g. ReaControlMIDI), moving the volume/pan fader within the track's routing window will generate MIDI CC7/CC10 events. When a send's MIDI routing button is enabled, these CC events are sent to the destination track.

ReWire users note that MIDI data routed in this way can be also be mapped to ReWire, using any permutation of buses/channels that you require. For more information about [using ReWire with REAPER](#), see Chapter 17.

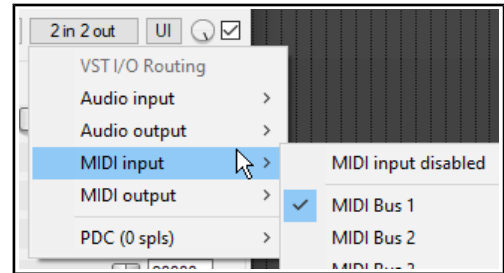

13.40 ReaControlMIDI

ReaControlMIDI can be used to set a track's various MIDI parameters, including volume and pan. It can be inserted from the track's FX chain, or by right-clicking over the track name or number and choosing **MIDI track control** then **Show MIDI track control panel** from the menu.

You can use different instances of this plug-per track to send different MIDI messages to different channels (for example, to send control messages to a synth or virtual instrument placed after ReaControlMIDI in the FX chain).

Many DAWs have MIDI tracks with MIDI-specific controls, like bank/program select, MIDI volume and pan, etc. REAPER instead uses ReaControlMIDI, which provides a MIDI track TCP for any track.

You can insert multiple instances of ReaControlMIDI, or insert it at any point in an FX chain, either for the track as a whole or for individual items. Notable features of ReaControlMIDI include:

Load File: You can load a REAPER .reabank file or Cakewalk .ins file of instrument definitions and then select a preferred bank/program combination.

Control Change: Up to five CC items can be selected from the drop down lists. Any and all of the items available for CC lanes in the MIDI Editor are available.

Show Log reveals a log of MIDI activities. You can choose to include any or all of **control change**, **sysex**, **all-notes-off** and/or **meta-message** activities.

With ReaControlMIDI you can also create MIDI CC track envelopes to automate any of the plug-in's enabled CC sliders. Automation will be explained in [Chapters 18](#) and [19](#). You can also assign track controls to the TCP and/or MCP to manage its various parameters. This is explained in [Chapter 11](#).

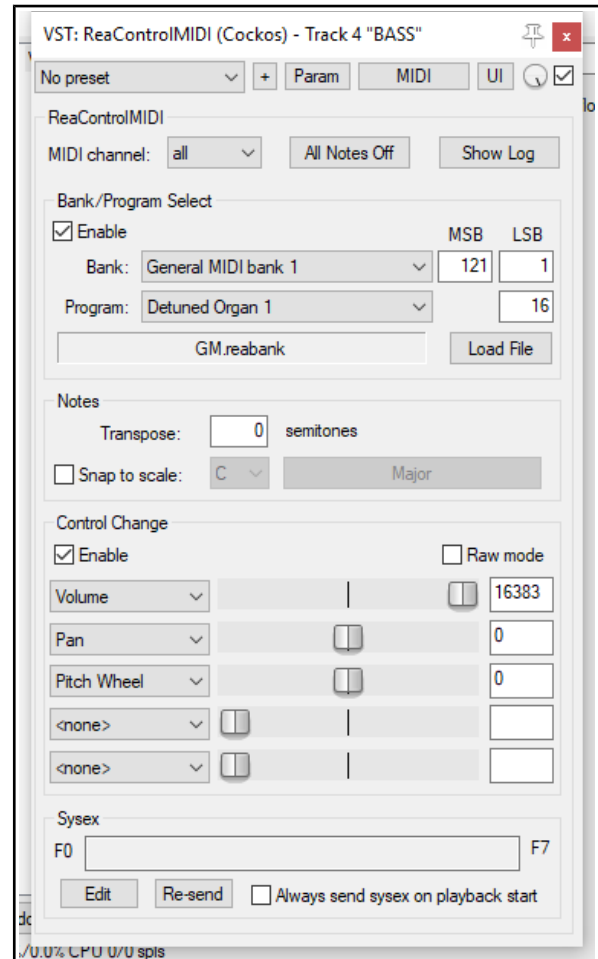

13.41 Some MIDI Plug-ins

REAPER includes about 40 JS MIDI plug-ins that can be placed in the FX chain of any of your MIDI tracks or MIDI items. The basic steps involved in inserting and using Track FX are covered in the section Track FX Basics. If you are unfamiliar with these steps, you should review that section before proceeding.

If you display the **Add FX** window and type *midi* into the filter list box (as shown above), you will see a list of those Midi FX that are currently available. Below are listed just a few examples.



For a bound hard copy of the latest version of this User Guide (printed in B&W) go to LULU.com

MIDI CC LFO Generator	A LFO Controlled CC generator.
MIDI Duplicate Note Filter	Blocks duplicate notes.
MIDI Map To Key	A MIDI key mapping utility.
MIDI Snap To Key	This is a good cheat for bad pianists.
MIDI Router/Transpose	Routes events from one channel to another
MIDI Tool and MIDI Tool II	These do interesting and fun things to MIDI note events.
MIDI Transpose Notes	Transposes a note or a range of note.
MIDI Velocity Variation Generator	This is a pattern based velocity modifier.
MIDI Velocity Control	Used to vary and control velocity on a MIDI track.
MIDI Pitch Wheel LFO	A LFO Controlled automatic pitch wobulator.

These plug-ins can be made even more powerful by the use of automation envelopes, which can be applied to any of their parameters. How to create, manage and apply [automation envelopes](#) will be covered in Chapter 18.

For more information about how to use these and other MIDI plug-ins, visit the Cockos web site, and in particular http://www.cockos.com/wiki/index.php/Jesusonic_Effects_Documentation#MIDI

13.42 MIDI Controlled Pitch Shift with ReaVoice

The **ReaVoice** plug-in can be used in conjunction with a recorded vocal track to create pitch shift harmonies. As with many other plug-ins, **ReaVoice** can be used in a number of ways. In this section we will take you thru just one example. After completing this example you should be able to experiment with this plug-in's capabilities for yourself. The procedure for using ReaVoice is as follows:

- Record the Vocal Track.
- Insert a new track immediately below the Vocal Track.
- Create a send from the Vocal Track to the new track. Initially at least, this should be Pre FX.
- Insert ReaVoice into the FX Window of the new track.
- Arm this track for recording. Make your MIDI keyboard the Input Device and turn Input Monitoring on.
- Mute all tracks except these two.
- Play the song. As you do so, play the keyboard, experimenting until you find an appropriate range of notes.
- Work out what you want to play, press **W** to return to the beginning, then **Ctrl R** to record. Stop recording when finished.
- If you do not have a MIDI keyboard, you can either use REAPER's Virtual keyboard, or you can enter the notes by hand using the MIDI Editor.
- If you wish, you can record more than one take, selecting **Play All Takes** for the MIDI track items.
- After finishing recording, you can use the MIDI Editor to polish your work.

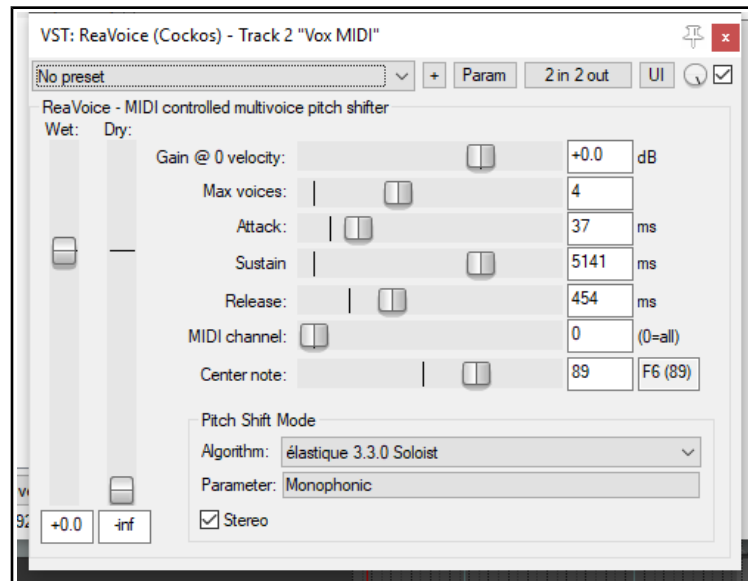

Example

In this example, you'll have some fun and explore how ReaVoice works at the same time.

1. Open the file **All Through The Night.rpp** and save it as **All Through The Night REAVOICE.rpp**.
2. Mute all tracks except the Vox track.
3. Move the Vox track to the top, select it and press **Ctrl T** to insert a new track. Your Vox track is now track 1 and the new track is track 2.

Working with MIDI Items

- Name the new track **Vox MIDI**.
- Display the **Routing** window for the **Vox MIDI** track and add a new **Pre FX Receive** on **Audio 1/2** from the **Vox** track.
- Insert the **ReaVoice** plug-in into the FX chain for this track. For now make its settings as shown above. Note in particular the number of voices and the long sustain setting.
- In the **Vox MIDI** track, insert an empty MIDI item from about the 13 sec mark to about the 50 sec mark. This should coincide with the first vocal passage on the Vox track.
- Double click on this to open it in the MIDI Editor.
- Create a pattern of notes similar to that shown above. You don't need to follow this precise pattern!.
- As you play the song, make sure that the two vocal tracks are soloed. You can of course edit any individual note or notes, for example, by moving them up or down, by lengthening them or shortening them, or by changing their pitch. Here are some more possibilities, just for fun and to give you some ideas.
- Within the MIDI Editor window, press **Ctrl A** to select all events.
- Press **Ctrl F2** to display the **Event Properties** dialog box.
- Select **Note** as the Event Type. In the **Note** value box, type **+2** (as shown) then click on **OK**. This raises the entire selection by two semitones.
- Play the song. Notice the vocal effect!
- Experiment with other settings as you wish. Save the file finished.
- Now experiment with adjusting some of the ReaVoice settings.

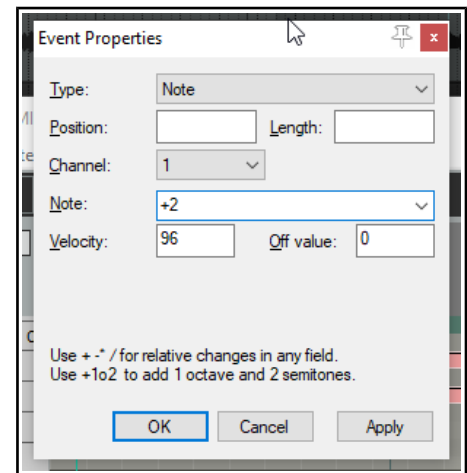
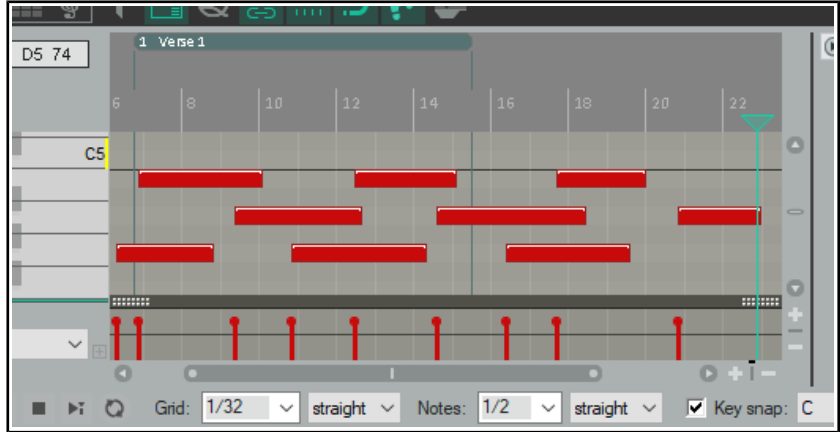

13.43 The Scale Finder

- REAPER's main Arrange View includes a feature that MIDI users may find useful – the Scale Finder. It can be used to identify those scales which contain any given set of notes.
- The Scale Finder is opened using the command **View** then **Scale finder**. Notes can be typed directly or entered using a MIDI device (including the Virtual MIDI Keyboard).
- The file sample reascale (provided and installed with REAPER) can be used with the scale finder, or you can click on the button at the bottom of this window and use the Load command to import a file of your own choosing.

You also have the option to use the notes that are currently selected in the MIDI Editor.

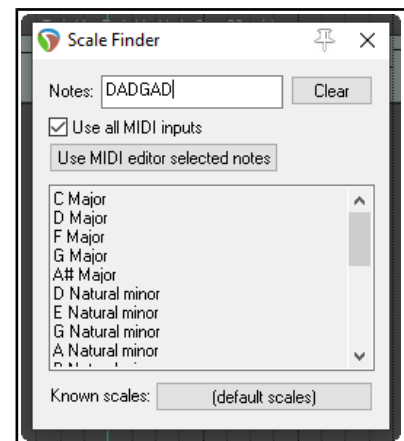

13.44 MIDI Item Source Properties

The MIDI Item Source Properties dialog box (shown right) is accessed from Arrange View by choosing **Source properties...** from the right-click context menu.

This dialog displays basic information about the MIDI item, such as the number of MIDI events it contains. In addition, you are able to specify a number of options here, such as:

- Only play selected channels.
- Send as channel number.
- Overwrite project tempo.
- If the item is **pooled**, options to select all pooled items or to unpool the item.

13.45 Feedback Routing with MIDI Tracks

We have already mentioned (Chapter 2) that REAPER's **project settings** allow you to use feedback routing. You will need to enable this feature if you wish to route MIDI output from one track to another, then audio output from the second track back to the first.

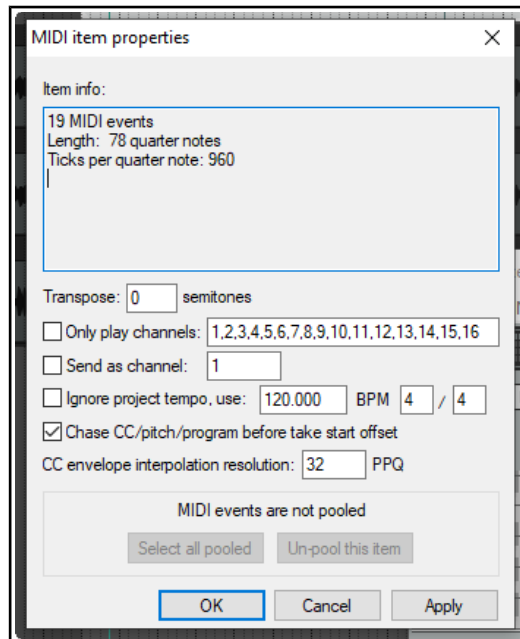

13.46 Working with Piano Roll Synced to Project Arrange View

Here is an example of how you can work with the MIDI Editor piano roll synced to the project. This is what we have done:

1. Imported a sample or recorded an instrument as a wave file, then edited it as we wished.
2. Created a new empty MIDI item and double-clicked to open it in the MIDI editor.
3. Used the MIDI editor command **View, Piano roll timebase, Project synced**.
4. Right-clicked on title bar and chosen **Dock Window**.

We can now work in the MIDI Editor as we wish: any MIDI editor notes and/or other events that we record/add will be visually aligned with the recorded instrument.

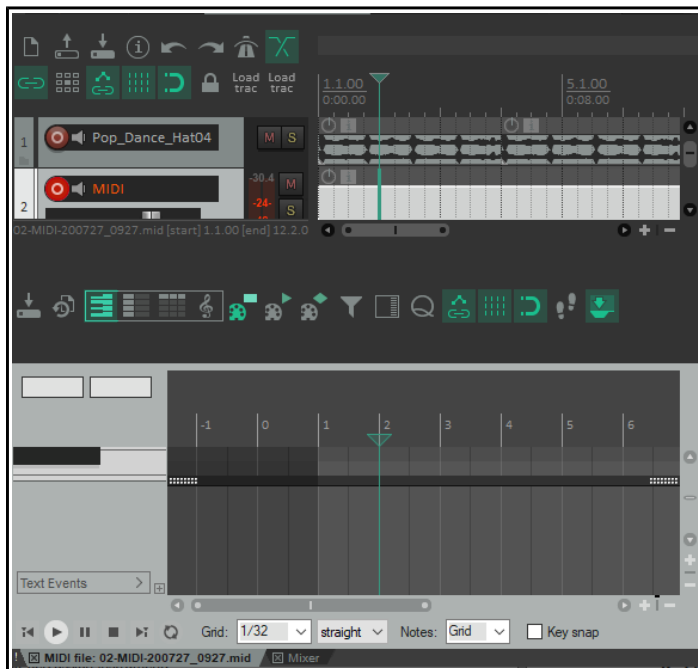

13.47 Sequencer Megababy

Sequencer Baby is a pattern sequencer which can be used to play a MIDI synthesizer under program control. This section is intended to

introduce relatively new users to the concept of pattern sequencing, together with a simple example of how one can be used. Beyond this, don't hesitate to explore and experiment for yourself!

We'll start by working thru a step by step example, then go on to examine Sequencer Megababy in more detail.

Example

1. Create a new file, and insert a single track.
2. Open the track's FX chain and add an instance of **JS: MIDI Sequencer Megababy**.
3. You need a synthesizer to use with Sequencer Megababy. You could use one of your choice, but for this example insert an instance of **ReaSynth**. For now, leave its settings at their defaults, except (as a

Working with MIDI Items

- precaution) Volume. Set this to about -15 dB. If this turns out to be too low, you can later raise it.
- Also as a precaution, insert the **JS: MGA JS Limiter** and set **Ceiling** to -3.0 dB.
 - Select the Sequencer Baby plugin. Some of its main controls are shown below.
 - Click and drag in a few places (example shown below) to enter a note pattern.
 - Click **Play** on REAPER's transport bar. This pattern will play over and over again.
 - Stop playback. Change the **Steps per beat** value to 8 and play again. Notice the music plays faster.
 - Set this to 2: notice playback becomes slower. Set this back to 4.
 - Change **Sequence length** to 24. The sequence becomes longer. Draw some more notes.
 - Click on the number **1** above the pattern grid (but below the parameter controls). A new screen is shown: here you can create another pattern. Do this!
 - Now hold the **Alt** button while clicking on the number **1** button. Notice the column headers change color.
 - Play the music. The two patterns (0 and 1) are now chained. You can chain up to 16 patterns.
 - If you wish, save the file.
 - You can also record the synth's output as an audio item. Arm the track for recording, choose **Record output (stereo)**

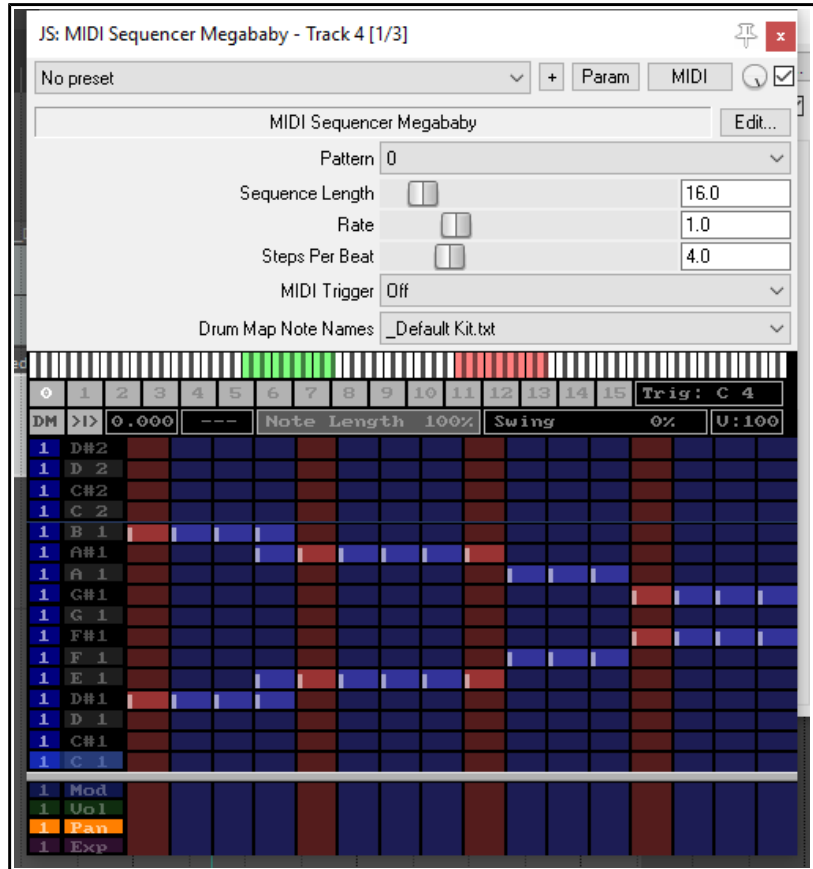

from the record arm context menu, then press **Ctrl R**.

Note: The four lanes below the pattern grid area can be used to set modulation, volume, pan and/or expression values for individual notes or any sequence of notes. Click/sweep to create an envelope: right-click on any node to delete it, right-click/sweep to delete entire envelope.

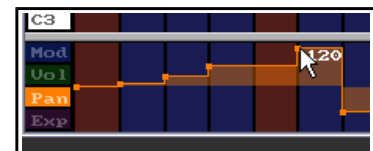

Summary Examples of Sequencer Baby Keyboard/Mouse Control Combinations

- | | |
|---|--|
| Left click-drag | Draw new notes/ erase existing notes. |
| Right click-drag | Audition notes without drawing. |
| Shift Ctrl Alt Left click-drag | "Sweep" draw notes freehand / erase existing notes. |
| Ctrl Left click-drag | Adjust note velocity. |
| Shift Left click-drag | Adjust note start offset.. |
| Ctrl Left-click / Ctrl Right-click | Halve steps per beat, slow down / Double steps per beat, speed up. |
| Left click pattern number | Select pattern number. |
| Ctrl right-click pattern number | Clear pattern. |
| Alt Left-click pattern number | Set pattern chain end. |

A more complete list can be displayed by clicking on the plugin's **Edit** button.

13.48 Using MIDI CC Messages to Control FX Presets

This is an advanced topic and as such not recommended for novice users.

Bank/Program Select CC messages can be used to switch programmatically between presets for any FX on any track during playback in real time. This can be done using a dedicated MIDI item that is placed on the same track as the media item containing the FX whose presets you wish to automate. The procedure can be a little bit “fussy” so be prepared to take your time over this, especially at first, until you get used to it.

1. After recording the item, insert the required FX into the track's FX chain and (if it is not already displayed) import the required preset library. To do this, click on the + symbol to the right of the presets drop down and choose **Import preset library (.rpl)**.

2. The available presets can now be displayed from the presets drop down list. The example here shows the default presets library for ReaDelay, but you can do this for any plug-in. You could delete any presets that you do not wish to keep and/or create and save more presets of your own if you wish. The self-evident commands for doing this can be found on the same presets + menu that you used in step 1. above. If you do this, it is recommended that you then export the presets library with a new name. For the purposes of this example, we will be content to use just the supplied set of ReaDelay presets shown on the right.

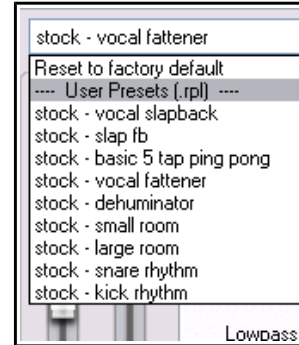

3. You now need to create a .reabank patch/bank file. This is in fact an ordinary text file, but it must be laid out in a certain way, and it must be saved with a .reabank extension. You can use any text editor for this.
4. Joel Sampson has available (free of charge) on his web site an excellent and comprehensive five page PDF manual explaining just about every aspect of reabank files and how to create them. Summary instructions follow below, but I would strongly recommend that you download and study **The Art of Reabanks** from www.djemberecords.com/reaper.html
5. An example of a reabank file for the default ReaDelay preset library is shown below. In this case, Notepad has been used to create the file. Note the comments at steps 7 and 8.
6. The bank line is the first line of the file. It sets the most significant byte (MSB) and least significant byte (LSB) of the Bank Select number, then the bank name. You can set both numbers at zero.
7. Each subsequent line consists of a patch number (starting at zero) and \name, which is shown here the same as the name displayed in the FX presets drop down. However, you may use different names if you wish, as the selection process is based on the patch number.
8. Save the file and close the text editor when finished. A sensible place to save to is in a subfolder of your \Application Data\REAPER\Data folder or equivalent (depending on whether you are using Windows or Mac).
9. Start REAPER and open the appropriate track's FX chain. Select the FX. From the preset + menu select **Link to MIDI program change** and select a channel (e.g. Channel 16).
10. In the track's context menu, set **Free item positioning** on to ensure that you can place two or more items underneath each other on the same track.. This command will now appear on this menu with a tick beside it.
11. Select the track with the media item whose FX plug-in presets you wish to control. Make a time selection that includes this item. Now from the **Insert** menu choose **New MIDI item** to create an empty MIDI item alongside (parallel to) the existing media item. The result of this is shown below:

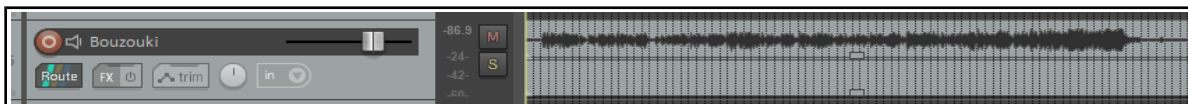
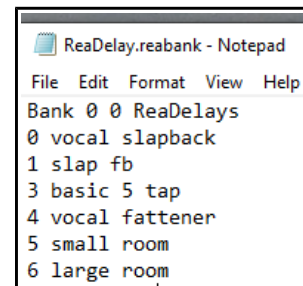

13. Open the empty MIDI item in the MIDI Editor. Ensure that the **Bank/Program Select** lane is visible.
14. At the point where you want to make your first automated preset change, double-click in the Bank/Program Select CC lane. This will display the Bank/Program Select dialog box.
15. Click on **Load File**. Navigate to and select the file that you saved at step 9. and click on **Open**.
16. The preset bank will now be loaded. Display the Program drop down list and select the required preset (see right). Be sure to select the same channel as you specified at step 10. Click on **OK**.

Working with MIDI Items

- Repeat step 16. as many times as you wish to create as many automated preset changes as you require.
- You should now be able to see your program changes displayed in the MIDI Editor CC lane (see below).
- Play the song. Your ReaDelay presets will now automatically change according to your instructions!

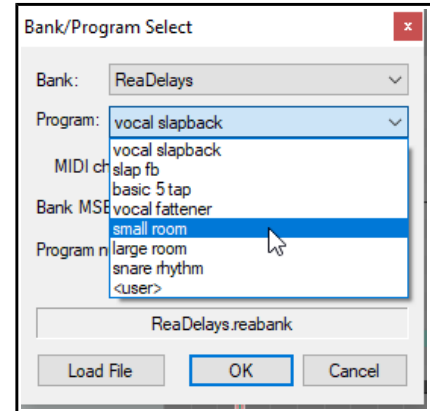
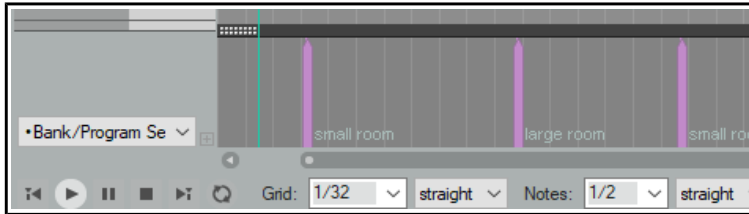

13.49 Custom MIDI Note and CC Names

You can define your own MIDI note and CC names and save them into a text file, which can then be imported into any MIDI project file using the command **File, Note names, Load note names from file**. A sample file is provided with REAPER: you can edit this file to suit your needs, or create your own files using any standard text editor.

To locate the sample file, choose from the main arrange view menu the command **Options, Show REAPER resource path**, then double-click on the folder **MIDINameNames** to open it. You should then see a file named **note_name_sample.txt**. Right-click on this file name and choose **Edit** from the context menu to open it in your default text editor. The sample file content is shown here (right).

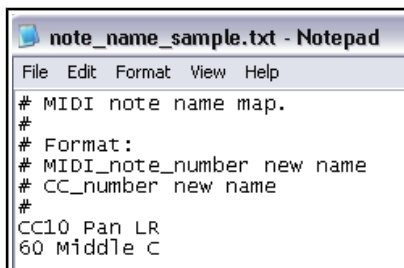

The # sign at the start of each line means it is a comment for illustration only and will be ignored by REAPER. To create actual names, simply type the extra lines in the format shown (without the #). An example is shown on the left. You can also delete any comment lines that you do not wish to keep.

Save the file and close the text editor. This file can now be imported into any project file, using the method described in the [MIDI Editor Menus](#) section.

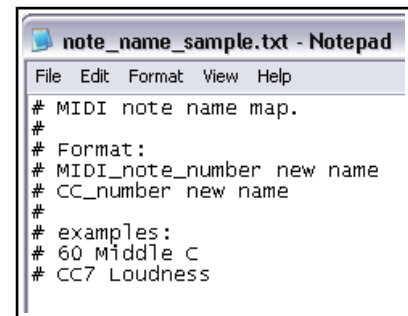

13.50 Recording and Routing thru MIDI Channels

Recording Thru MIDI Channels

If you don't hear any sound coming from REAPER when you play your keyboard then (assuming the keyboard is switched on and physically connected to your computer or sound card) most likely one (or more) of these circumstances may apply:

- The MIDI Keyboard has not been installed for REAPER. See the section [Setting Up For MIDI](#).
- Channel mismatch: the channel being used by your keyboard for MIDI output does not match the channel selected on the REAPER track for MIDI input.
- The REAPER track has not been record armed.
- Input monitoring is not been enabled

Most MIDI keyboards let you select which channel is used for MIDI output. Many use channel 1 by default. You will need to check your keyboard's documentation to find out how to select a MIDI channel of your choice (from 1 to 16) for MIDI output.

To select a MIDI channel for REAPER input, first right-click on the track control panel over the red record arm button. You should then choose (from the menu) **Input MIDI**, then the device, then select the channel of your choice, or all channels.



Up and Running: A REAPER User Guide v 7.31

Input monitoring can be enabled from the same menu. Record arm is enabled by clicking on the red button to the left of the track name.

Within some instrument plug-ins (e.g. Kontakt, SampleTank) you can select which of the 16 MIDI channels will drive each loaded instrument: you will need to check out the plug-in's user manual.

The same applies for some effects plug-ins (e.g. those from MeldaProduction, where MIDI can be used to automate the plug-in parameters).

See also the section [Recording MIDI from Keyboard Check List](#).

Routing with MIDI Channels

The section [REAPER Routing Essentials](#) introduces track sends in REAPER. You might wish to review this.

The same principles apply whether you are routing audio or MIDI data from one track to another. You can send data from any channel (or all channels) on one track to any channel (or all channels) on another track.

In the example shown (above right), drag and drop routing (from the send track's routing button to the receiving track on the track control panel) has been used to send MIDI data from track 4 channel 3 to track 5 channel 1. Note that the audio send is set to None.

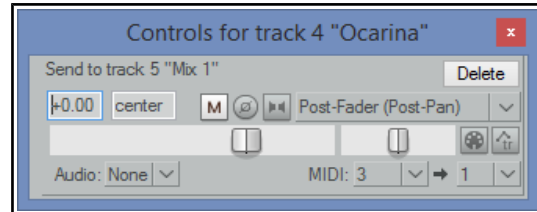

Routing with MIDI Buses

REAPER's MIDI track routing capabilities includes the use of MIDI buses. By default, your MIDI tracks can use up to 256 MIDI buses, each comprising 16 MIDI channels. When sending MIDI data from one track to another, you are able to specify bus/channel combinations for both the source and destination tracks.

REAPER's 256 MIDI Buses vastly increase the MIDI routing options available to you. Each bus can carry up to 16 channels, offering you 2048 virtual MIDI channels.

This is an advanced topic, not recommended for novice users! You'll find a detailed explanation of MIDI Buses together with some practical examples in [Chapter 17](#).

13.51 Retroactive MIDI Recording

REAPER's action list (main section) includes five actions which enable you to record MIDI material retroactively. This enables you to experiment with your keyboard so that if you create a passage that you like you can retroactively record it. These actions (which can be assigned to a toolbar if you wish) are:

MIDI: Clear retroactive history

MIDI: Insert all available retroactively recorded for armed and selected tracks

MIDI: Insert all available retroactively recorded for armed tracks

MIDI: Insert recent retroactively recorded for armed and selected tracks

MIDI: Insert recent retroactively recorded for armed selected tracks

Example

This example uses REAPER's Virtual MIDI Keyboard, but you could use any installed external MIDI input device.

1. In Arrange view, create a new track and add a virtual instrument (e.g. ReaSynth) to its FX chain.
2. Click on the track's red record arm button to arm it. Right click over the button and make sure that **Monitor input** is enabled.
3. Right click on the record arm button, select Input MIDI, then your input device (e.g. Virtual MIDI keyboard), then a channel or All Channels.
4. Run the action **MIDI: Clear retroactive history** to clear out any existing history from the buffer.
5. Arm the track but do *not* press the record or play buttons on the transport bar.
6. Make sure that this track is selected and play a few notes on your input device. Stop playing after a few seconds.
7. Run the action **MIDI: Insert recent retroactively recorded for armed and selected tracks**
8. The notes that you have just played will be inserted as a new midi item.

14 Music Notation and REAPER's Notation Editor

14.1 A Brief Introduction to Notation

In a broad sense, the term *notation* can be applied to any system that uses written symbols to represent musical notes. Thus, the piano roll view of REAPER's MIDI Editor can be seen as a type of notation, as is the use of guitar tabs, which you might have encountered elsewhere. However, in practice the term "notation" is often used to refer to modern staff notation. This was developed for use with European classical music, but is now widely used to represent music of many genres. This chapter will focus on the use of REAPER's notation editor for modern staff notation. First, here is a general introduction.

The practice of notation writing is sometimes also known as *scoring*. Notation is a huge subject about which there is much to learn, and the journey from complete beginner to competent achiever can be a long one. Many books are available on the subject, including *Music Notation (Theory and Technique for Music Notation)* by Mark McGrain and *Music Notation and Terminology* by Karl Wilson Gehrkens (available on line as a free download from Gutenberg). A handy short general introduction to understanding music theory and notation can be found on line at method-behind-the-music.com and tutorials at http://jkornfeld.net/complete_theory_text.pdf

If all this intimidates you, don't let it! You don't need to be able to read or write musical scores to be a musician. Robert Johnson, John Lennon, Paul McCartney, Bob Dylan, Jimi Hendrix, Eric Clapton, Tommy Emmanuel and many, many others are all proof of that!

This User Guide does not aim for the impossible goal of teaching everybody everything they could ever wish to know about notation scoring and editing, in just a few pages! Its purpose is to help you to learn how to start using REAPER's notation editor with such knowledge and skills as you can bring to the table.

Below are illustrated some of the basic elements and terminology of notation scoring:

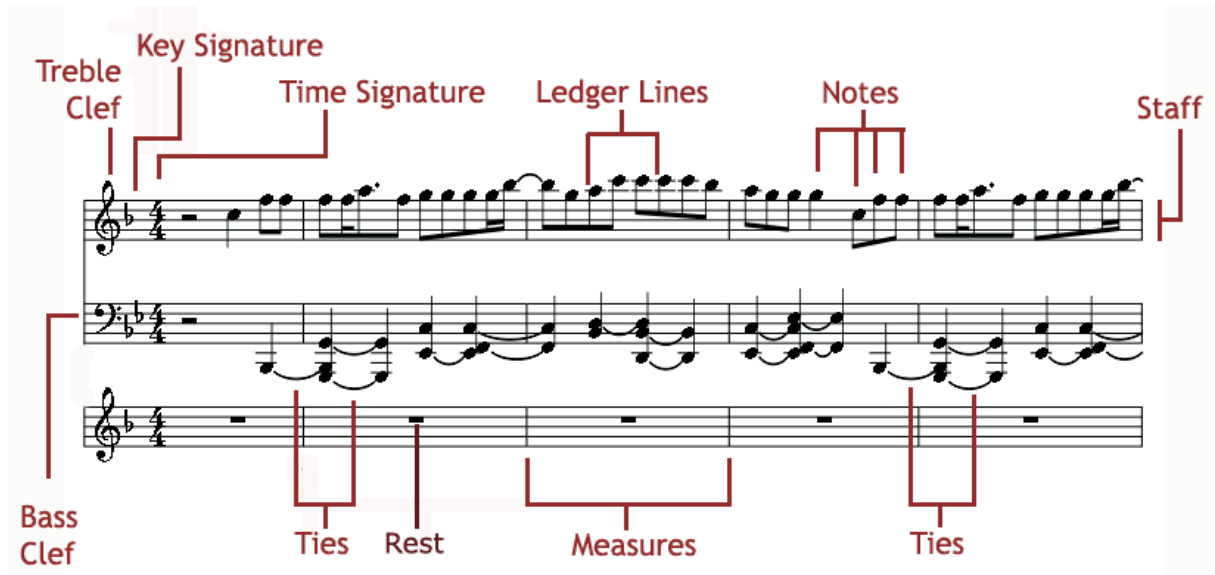

The **staff** is the five line grid on which notes can be written, and which is used to display the notes. If a MIDI item recorded using a keyboard or created by hand within the MIDI editor is opened in the notation editor, then that item will be automatically scored. You can also edit that score, or add to it, within the notation editor. The staff is divided into a number of **measures** for the duration of the piece. The number of beats to a measure is itself determined by the **time signature** (see also below).

On the left end of the staff is displayed the **clef**. For the **treble clef** the first (lowest) line of the staff represents **E** this goes up alternately thru grid spaces and lines to **F, G, A, B, C, D, E**, and **F**. The **bass clef** uses the same musical alphabet but goes up **G, A, B, C, D, E, F, G**, and **A**. Where a note needs to be displayed above or below the range covered by the staff, this is done using **ledger lines**.

A different symbol is used to represent each **note**, from double whole note or breve (not shown) thru (shown from left to right below) whole note (semibreve), half note (minim), quarter note (crotchet), eighth note (quaver), sixteenth note (semiquaver), thirty-second note (demi-semiquaver) and sixty-fourth note (semi-demi-

Up and Running: A REAPER User Guide v 7.31

semiquaver). Above you can see where **ties** have been used to join together two or more adjacent notes of the same pitch, effectively creating a single longer note.

To the immediate right of the clef are the **key signature** (if present) and the **time signature**. The **key signature** designates notes to be played higher or lower than its corresponding natural note. The **time signature**

determines how many beats there are per measure, and what kind of note gets the beat. For example, in 4/4 time there are four beats per measure with the quarter note getting the beat. In 3/4 time also the quarter note will get the beat, but with only three beats in a measure.

Finally in the diagram you can see **Rests**. A rest represents a period of silence in a bar. The duration of the rest corresponds to a note length and is indicated by the symbol used, as illustrated in the examples shown on the right.



14.2 REAPER's Notation Editor: a First Look

The single most important thing for you to understand about REAPER's notation editor is this:

It is a fully integrated part of the MIDI Editor, not a stand-alone module. Any changes you make when editing will be to the MIDI item itself, and will show up in every view. This architecture has a number of significant advantages, such as:

- If you are familiar with working in, say, [piano roll view](#), then learning to use the notation editor presents a significantly less steep learning curve than would otherwise be the case. Indeed, you would probably be unwise to attempt to use the notation editor without first getting to know the MIDI Editor, and especially piano roll view.
- You can make your edits (such as moving, copying or modifying notes) in whichever view you find it easiest to work. The results of the edits will be visible (and audible) in any view.

The MIDI Editor's different views are selected from the **View** menu. The different modes (already introduced in [Chapter 13](#)) are:

Mode: piano roll (Alt 1)

Mode: named notes (Alt 2)

Mode: event list (Alt 3)

Mode: musical notation (Alt 4)

Consider the example on the right. This is a fairly simple MIDI item. It could have been imported from an external MIDI file, recorded using a keyboard, or crafted in the REAPER MIDI Editor piano roll view or musical notation view. It is shown here in piano roll view (top) and musical notation view. When you switch between views, you are seeing exactly the same notes each time.

You can also see that the MIDI editor environment is also the same. For example, the menus and toolbars are the same, as is the essential MIDI Editor functionality. In either of the two view shown here, for example, you can add, delete or move notes.

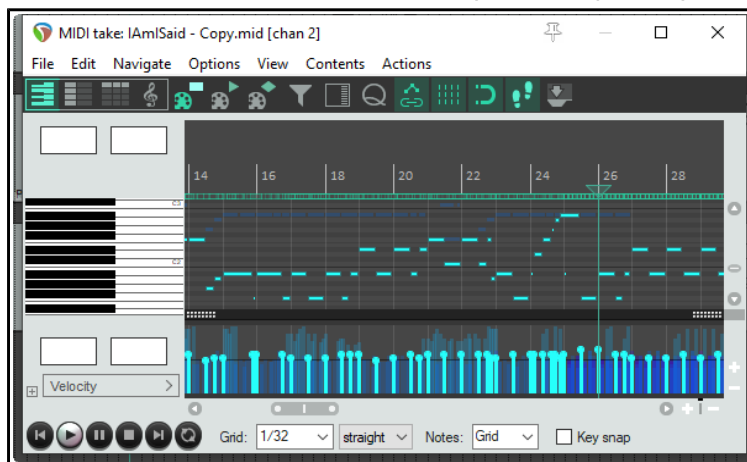

Music Notation and REAPER's Notation Editor

Note that a MIDI item can be displayed in only one view at a time (e.g. musical notation mode or piano roll mode, but not both at once), although different items may be open at the same time in different views in separate MIDI Editor instances.

Note also that the methods employed when working within the different views (or modes) are as far as possible, the same.

For example, use double-click to insert a new note. Use right-click-drag to select a series of notes (**marquee**). You can perform tasks on your selection such as delete, move, copy, quantize or **humanize**, and so on.

As you will see later in this chapter, musical notation view also incorporates a large number of extra features that are specific to scoring music.

First, let's return for a moment to our simple example.

For example, you could add some more notes in the piano roll view.

When you switched to musical notation view, you would see that your edits were also displayed there.

Thus the process of working and moving between the different modes is quite seamless.

If you are working with projects which contain more than one track with MIDI items, and/or more than one MIDI item

per track, it is important that you understand your options for managing how the MIDI Editor (including musical notation mode) can handle these. You might already be familiar with this, from sections 13.27 to 13.29 of this guide. If necessary, refer back to these sections, but there follows a brief summary.

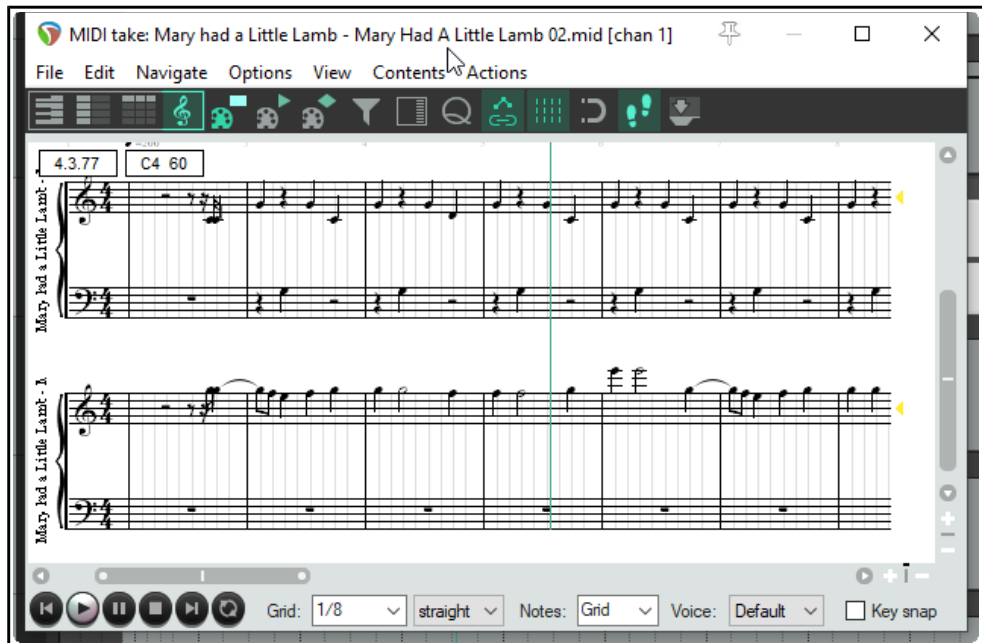
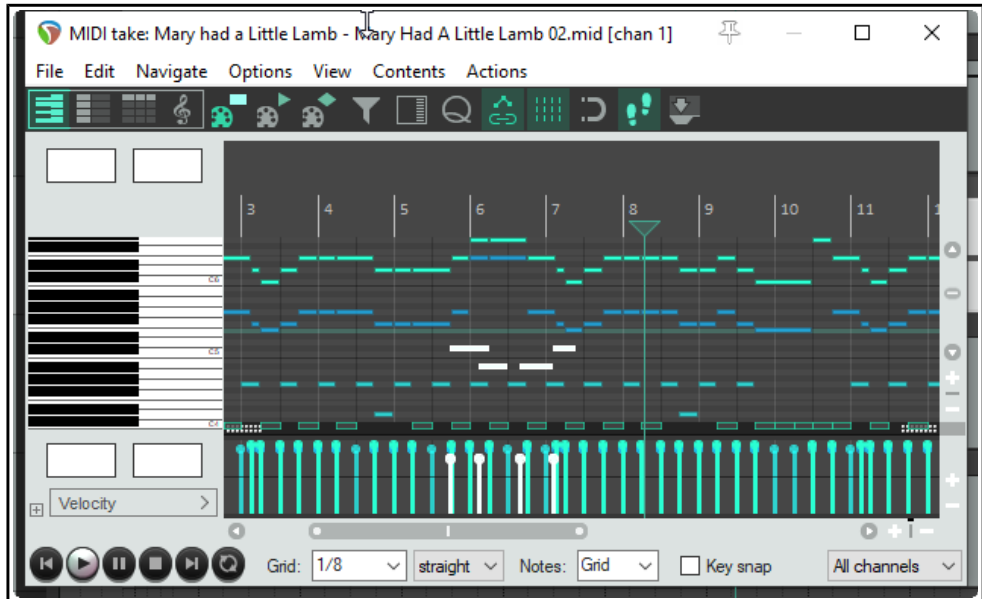

14.3 Opening MIDI Items in the Notation Editor

Under **Options, Preferences, Editing Behavior, MIDI Editor** you can specify your default preference as to whether you want one MIDI editor instance opened for each item, for each track, or for the entire project. When in musical notation mode, it can often be helpful to have all MIDI items open together.

On the same page, you can also determine what happens by default when you open a MIDI item in the MIDI Editor, either by double-clicking, or using the **Open in built-in editor** command. The options are to open the clicked item only, all selected MIDI items, all MIDI items on the same track, or all MIDI items in the project. Your default setting can be overridden for individual projects from the MIDI Editor's Contents menu. There are also a number of other options, shown above.

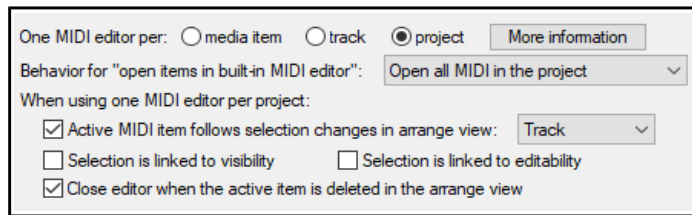

14.4 REAPER's Notation Editor: A Closer Look

Once opened, musical notation mode can be selected (**View** menu) and the option to view the track list should be enabled from the **Contents** menu. This can be used, amongst other things, to determine which items are visible and optionally editable, as well as which is to be used when inserting notes (see 13.27 to 13.29). You should make sure that you have a sound understanding of the track list and its features before working in musical notation view.

Shown here is an example of a folder with a synth inserted in its FX chain and two child tracks, each containing a MIDI item. Both are open together in the MIDI Editor's musical notation view. By looking at the panel on the right you should be able to see that both tracks are visible in this window. Both are currently selected as editable: the first has also been selected for inserting any new notes.

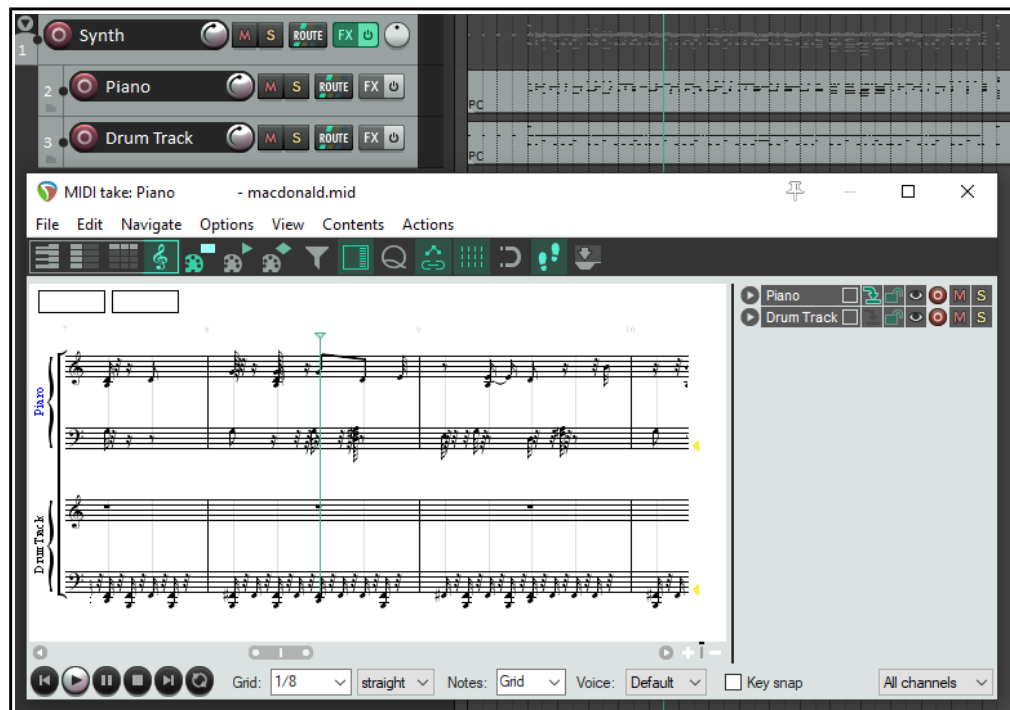

Let's look first at some of the things that you can already see here:

- If more than one track is visible, track names are displayed to the left of the staff. Both track and item names are visible in the track list panel. Clicking on the track name (in the notation or in the track panel) will make that track the target track for inserting events, and will make the items on that track editable.
- Notes that are not currently editable are shown in a lighter shade of gray.
- There are two boxes at the top left corner of the display, just below the toolbar. If you hover your mouse over any note, these boxes will display that note's time position and pitch.
- The tempo is displayed above and slightly to the right of the time signature.

Music Notation and REAPER's Notation Editor

- To the right of the page, at the end of each pair of rows there is a pitch cursor in the form of a small gray triangle. This shows the current pitch that will apply when keyboard actions such as insert note are applied. An accidental (sharp or flat) will be shown beside it if the pitch is not in the current key. This symbol is editable by dragging up or down with the mouse.

Now let's take a look at some other features that might not be as immediately apparent. You can see several things in this illustration, which will be explained shortly.

- Lyrics have been added just below the first staff.
- Notations (in this example, crescendo, play very loud, and diminuendo) have been made above the staff.
- A time selection and separate loop selection have been made. This could initially have been done in arrange view, but can also be edited in notation mode. For example, you can grab the handles with the mouse to adjust the start and end points of the loop.
- Some notes are also marked with color. These are the currently selected notes. How they are colored will depend which option you have set – channel or velocity or pitch, etc. Setting color to velocity can be especially useful, as in notation (as opposed to piano roll view) there is no other way to display velocity.



Example

Before digging any deeper, familiarise yourself with the basics of the musical notation mode environment. Make a copy of one of your MIDI projects, then, as a first exercise, strip it back to a few simple MIDI items on no more than two or three tracks.

Open this in the MIDI editor and get used to the feel and flavor of musical notation mode. Don't yet be too ambitious: restrict yourself at first to simple tasks like adding or deleting notes, moving or copying loop selections, etc. Get to grips with switching between modes and editing in both. Don't worry if you mess it up occasionally – it's just a scratch pad!

We'll get to explaining how you manage the other (and perhaps more interesting) features shortly, but there's a couple of other points worth making first.

14.5 Notation Editor View Options

The MIDI Editor main menu **View** command includes a number of notation view specific options:

Proportional (musical) note spacing.

Enabling this option selects proportional note spacing rather than absolute spacing (as in piano roll view) - see images, right. With absolute spacing (top image), the timing grid is evenly spaced, and the notes placed in their absolute timing positions on it. With proportional spacing (lower image) the grid is adjusted to suit this: longer notes need not take up their larger actual time-portion of the bar and the grid tends to be narrowed, shorter notes are no longer compressed into their actual short time-space and the grid is widened accordingly.

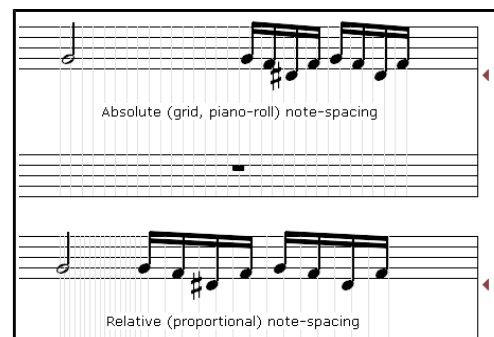

Continuous view always, regardless of zoom level:

This toggle option determines how your notation is displayed in the MIDI Editor: it is explained in [section 14.7](#).

Minimize ties for all notes by default: a toggle option.

Automatically double dot notes: a toggle option.

Automatically triple dot notes: a toggle option.

Display pedal events: A toggle to determine whether or not pedal events are shown.

Up and Running: A REAPER User Guide v 7.31

Bracket tracks by folder: Enabling this option will cause a bracket to be drawn to the left of the score to indicate where a number of consecutive tracks belong in the same folder.

Color note heads: Determines whether or not note heads are colored in accordance with whichever option has been selected (**View, Color notes by** command).

Position dynamics below the staff by default: a toggle option that determines positioning of dynamics on the staff.

Automatically detect triplets: a toggle option. Tuplets and triplets are discussed later in this chapter.

Automatically voice overlapping notes: Voicing allows the notes that make up a chord to be arranged in various ways so as to vary the sound. The automatic voicing of overlapping notes can be toggled on and off.

Show project tempo changes: A toggle to determine whether or not project tempo changes should be displayed above the score in the notation editor.

Key signatures: Allows you to specify how key signature should be managed. Sub-menu toggle options are **Key signature change affects all tracks** and **Transposing display affects key signatures..**

Display quantization: The default setting is 1/16 but you can use the slider to choose 1/64, 1/32 or 1/8.

Display quantization, Minimum note length: The default setting is 1/64, but you can use the slider to instead choose 1/256, 1/128, 1/32, 1/16 or 1/8.

Neither your display quantization nor your minimum note length settings will affect the underlying MIDI in any way. They only determine how notes are displayed. To understand how these two options work, you need to consider them together.

The display quantization setting ensures that for display purposes all but the shortest notes will be rounded to whatever value is selected. The minimum note length setting allows shorter notes to be displayed regardless of the display quantization setting. For example, if display quantization is set to 1/16 and minimum note length to 1/64 (the default settings), then notes slightly longer or shorter than 1/16 will be displayed as 1/16, those slightly longer or shorter than 1/8 will be displayed as 1/8, and so on. It will, however, still be possible to display notes shorter than 1/16, such as 1/32 or 1/64.

In addition, the **Contents** menu includes a toggle option **All media items are editable in notation view**.

14.6 Basic Note Selection and MIDI Editor Tasks

[Basic note selection](#) and [MIDI editing tasks](#) are covered in detail in Chapter 13, including the commands on the **Edit** menu. As well as the more obvious commands and actions, there are a number of mouse and keyboard shortcuts. Most mouse behaviors that work in the piano roll will also work in musical notation mode.

Zoom and Scroll

Make yourself familiar with the MIDI Editor's zoom and scroll controls. In addition to the various buttons and sliders displayed in the MIDI Editor window, the following mouse and keyboard actions are also useful:

Mousewheel: Horizontal Zoom (**Num +, Num -**) **Ctrl Mousewheel:** Vertical Zoom (**Pg Up, Pg Dn**)

Alt Mousewheel: Horizontal Scroll (**Alt Left, Alt Rt**) **Ctrl Alt Mousewheel:** Vertical Scroll (**Alt Up, Alt Dn**)

Common Tasks

Below are listed some common tasks that can be used in both the piano roll and musical notation mode..

Delete note or note selection	Marquee to make selection, press Delete .
Move note or note selection	Marquee to make selection, Click and drag to new position.
Copy note or note selection	Marquee to make selection, Ctrl click and drag to new position.

The Action List

You also have available to you **Actions:** The [MIDI Editor actions list](#) includes the notation mode commands as well as several actions not on the menus that are specific to notation mode, for example:

Notation: Hide selected notes	Notation: Minimize ties for all notes by default
Notation: Unhide all notes	Notation: Toggle minimize ties for selected notes
Notation: Select all notes in staff	Notation: Identify chords on editor grid **
Notation: Remove all chord notation	

** Applies to all notes playing, not just notes starting at the target time position.

Options like these can be enabled or disabled. You can also assign your own shortcut keys for any actions, or add them to the MIDI Editor's menus or toolbars. The actions list is covered in more detail in Chapter 15: some time spent browsing thru this list could prove to be time well spent.

Music Notation and REAPER's Notation Editor

Default Mouse Modifiers

REAPER includes a large number of default mouse actions. These can be customised thru the **Editing Behavior, Mouse Modifiers** page of your preferences. Generally most useful when working in the notation editor is the MIDI piano roll context, whose actions also apply in this environment. These are marked with ** in the table below.

Listed below are some of REAPER's default mouse modifiers. MIDI Editor mouse modifiers were introduced in [Chapter 13](#), and you can learn more about them in [Chapter 15](#).

This list includes examples of other categories (such as piano roll and MIDI note) that can be useful if your workflow finds you switching back and forth between the notation editor and the piano roll.

Piano Roll Left click **

Default	Deselect notes, move edit cursor.
Ctrl	Ditto, ignoring snap.
Alt	Deselect all notes.
Shift+Alt	Insert note ignoring snap.
Shift+Ctrl+Alt	Insert note.

Piano Roll Double click **

Default	Insert note.
Shift	Insert note, ignoring snap.

Piano Roll Left drag **

Default	Insert note, drag to extend.
Shift	Ditto, ignoring snap.
Ctrl	Copy selected note(s).
Alt	Erase notes.
Shift+Alt	Paint notes, ignoring snap.
Ctrl+Alt	Paint a straight line of notes.
Shift+Ctrl+Alt	Paint notes and chords.

MIDI Note, Double click

Default	Erase note
Shift	Activate MIDI item

MIDI Item Edge, Left drag

Default	Move edge
Ctrl	Ditto, ignoring group/selection
Alt	Stretch item
Ctrl+Alt	Ditto, ignoring group/selection

MIDI Editor, Right drag

Default action	Marquee select notes/CC.
Shift	Marquee add to notes/CC selection.
Ctrl	Marquee toggle notes/CC selection.
Alt	Marquee select notes/CC and time
Shift+Alt	Ditto, ignoring snap
Ctrl Alt	Select notes touched while dragging
Shift+Ctrl+Alt	Hand scroll

MIDI Note, Left drag

Default	Move note
Shift	Ditto, ignore snap
Ctrl	Copy note
Shift Ctrl	Move note on one axis only
Alt	End note velocity
Shift+Ctrl+Alt	Move note vertically, ignore scale

MIDI Note, Left click

Default	Select note, move edit cursor
Shift	Add range of notes to selection
Ctrl	Toggle note selection
Shift Ctrl	Select note, move cursor, no snap
Alt	Select note-
Shift+Alt	Select all notes in measure
Ctrl+Alt	Select note and all later notes

MIDI CC lane, Left click/drag

Default	Edit selected CC events if any
Shift	Insert CC event

This list is by no means comprehensive. You can explore the other possibilities yourself through **Options, Preferences, Editing Behavior, Mouse Modifiers**.

You should also make sure you understand the purpose of the MIDI Editor's other controls, especially those located near the bottom of the window, to the right of the transport bar. These are labelled **Grid, Notes, Scale**, etc. For example, the Notes drop down list sets the default length for new notes when they are inserted. If necessary, refer back to [Chapter 13, section 13.6](#).

14.7 Notation Editor Specific Tasks and Functions

Before delving too deeply into the notation mode's editing capabilities it's worth pausing to take on board a few **important points**:

- If you have several MIDI items open together in a single notation editor you should display the track list (**Contents, Track list**). This enables you to make sure that any item that you wish to work on is at least editable, and, for many actions, also selected as the target for inserting events. One simple way of doing this is to make it the only item visible at the time (below right).
- Within the MIDI editor track list, use **Ctrl Click** on any track name to close a track, or **Alt Click** to close all other tracks.

Up and Running: A REAPER User Guide v 7.31

- Each MIDI item can have its own key signature, or no key signature. If no key signature is specified for an item, it will take its key signature from the previous item on the same track. If there is no previous item on the same track and no key signature defined, it will not have a key signature.
- Only a relatively small number of the commands that are exclusive to musical notation view *affect the actual MIDI notes themselves*. These include deleting and inserting notes and setting tuplets. Other actions such as articulations, lyrics, notations, etc. *will only affect what is drawn on the page, not the underlying notes themselves*.
- You can right-click on the timeline (which displays the bar/measure numbers) to access the MIDI editor's general context menu.

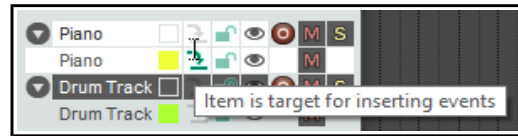

How the score is displayed

When only a single track is being viewed, the notation will by default be displayed as a page, running from left to right and top to bottom, unless you are zoomed so closely as to display less than one full measure.

When less than a full measure or more than one track is displayed, the display is continuous, running always and only from left to right. The MIDI Editor's main **View** menu includes a toggle **Notation view options, Continuous view always**. Enable this if you wish to use continuous view regardless of zoom level.

The Staff and Note Context Menus: Editing Commands and Options

The tables in this chapter use the default notation editor context menus, as they come with REAPER "out of the box." However, both the notation staff and the notation note context menus can be customised to suit your particular requirements. How to customise menus is explained in the chapter following this one.

Track/measure task	Method
Change default clef	<p>To change the default clef, right-click over the clef and select Default clef from the menu. Options include Treble + Bass, Treble, Bass, Alto, Tenor, Treble -8, Treble +8, Treble+15, Bass -8, Bass-15, Percussion Percussion (one-line) or Chart.</p> <p>The chart option creates a staff with no notes, just beat markings, chords, and other notations.</p>

Music Notation and REAPER's Notation Editor

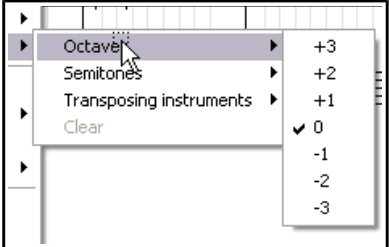
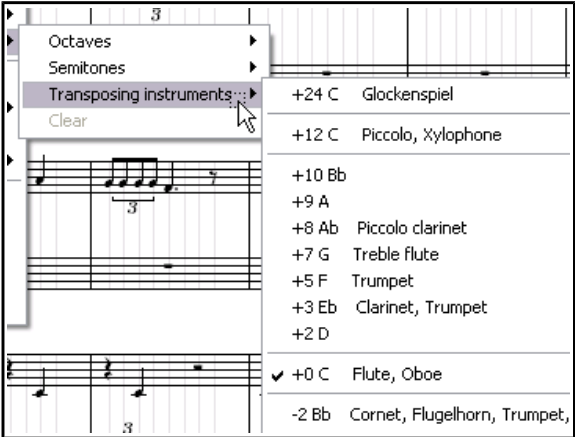
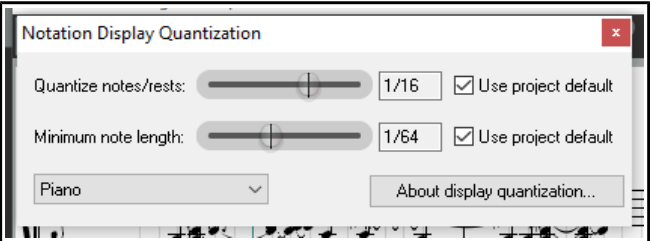
Track/measure task	Method
<p>Transposing note display: Octaves and Semitones</p> <p>(See also Transpose Options.)</p>	<p>The Transpose display command can be used to cause the notes on a track to be displayed up or down by up to 3 octaves and/or 11 semitones. This affects only the way notes are displayed, not the underlying MIDI. Right-click at the start of a measure, choose Transpose display from the context menu, then select Octaves or Semitones.</p> <p>Octaves can be transformed within a range of +3 to -3.</p> <p>Semitones can be transformed within a range of +11 to -11.</p> <p>You can transpose by a combination of octaves and semitones if you wish: simply use this command twice.</p> <p>Use the Clear command from this menu to restore transposed notes to their previous state.</p> 
<p>Transposing note display: Instruments</p> <p>(See also Transpose Options.)</p>	<p>To transpose notes for a specific instrument, choose Transpose instruments from the Transpose display menu, then make your choice. Part of the range of options for transposing instruments is shown on the right.</p> <p>For example, to transpose the <i>display</i> for a clarinet you would select +3 Eb.</p> <p>Transposing display by itself does not result in any changes being made to the MIDI data.</p> <p>Note, however, that you do also have an option to allow transposing display to affect key signatures. This is discussed towards the end of this table.</p> <p>Use the Clear command from this menu to restore transposed notes to their previous state.</p> 
<p>Display quantization</p>	<p>This command can be used to quantize your notation display, either for the whole project or on a per track basis. Tracks can be selected from the drop down list. Click on About display quantization... for further information.</p> 
<p>Changing the clef</p>	<p>To insert a new clef at the start of a measure, right-click over the existing clef and choose Change clef then select from the list of available choices. These choices are the same as those available on the Default clef menu.</p> <p>To delete such a clef, right click and choose Delete from the change clef menu.</p>

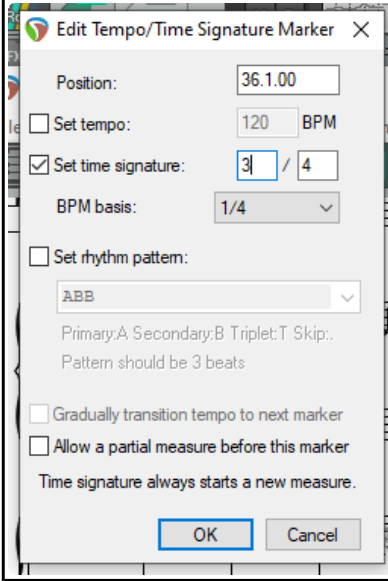
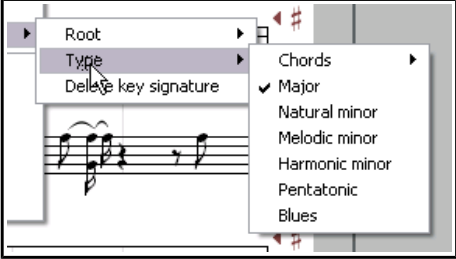
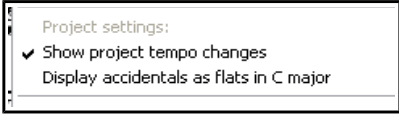
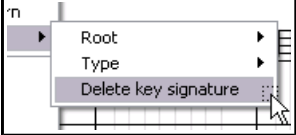
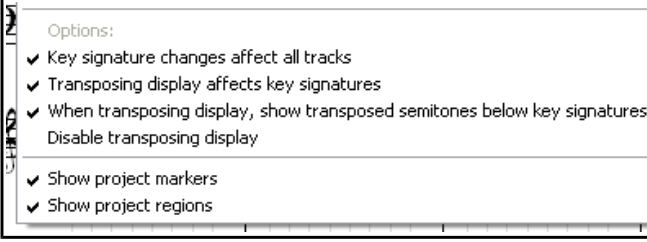
Track/measure task	Method
<p>Change tempo/ time signature/ rhythm pattern</p>	<p>To insert a time signature change at the start of any bar, right-click and choose Change tempo/ time signature/ rhythm pattern from the menu.</p> <p>This opens a dialog box (shown right) where you can make your changes.</p> <p>You can also change an existing tempo, time signature and/or the rhythm pattern setting in this way.</p> <p>Click OK to confirm.</p> 
<p>Change key signature</p>	<p>Use this command from the context menu to insert a key signature change at the start of a bar.</p> <p>You can then select a root and type from the flyout menu.</p> 
<p>Project settings options</p>	<p>After the measure setting options on the menu there are two project settings toggle options to determine the display of project tempo changes and accidentals (see right).</p> 
<p>Delete a key signature</p>	<p>Right-click over the key signature and choose Change key signature then Delete key signature from context menu.</p> 
<p>Options</p>	<p>This group comprises various toggle options.</p> <ul style="list-style-type: none"> Key signature changes affect all tracks Transposing display affects key signatures When transposing display, show transposed semitones below key sigs Disable transposing display Show project markers Show project regions 

Music Notation and REAPER's Notation Editor

General Editing Commands and Actions



You can right-click just about anywhere except on a note or item to display a general menu of notation editing commands. These include the usual general editing commands (Copy, Cut, Paste, etc.) as well as these notation view specific commands:

Dynamics, Text, Lyrics, Tuplet, Pedal, Voice, Hide Notes, Chords

These are explained in the table below.

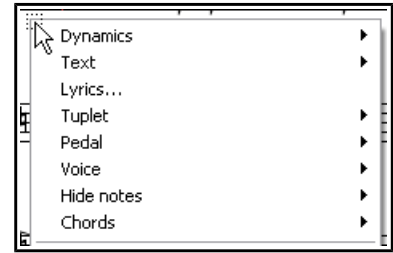
Note also that on the MIDI Editor main menu, the **View, Piano roll notes, Show notation text on notes** command can be used to display notation text in piano roll view.





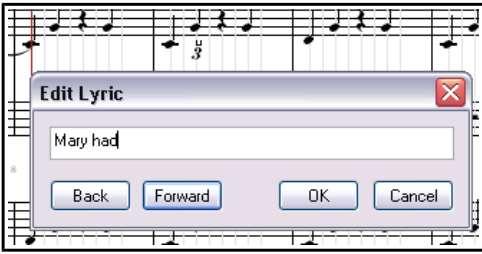
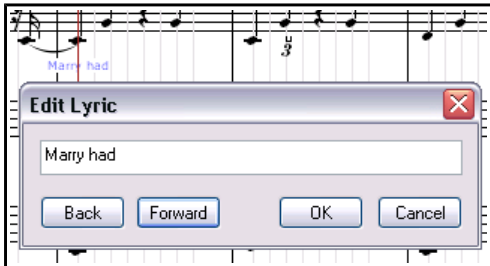
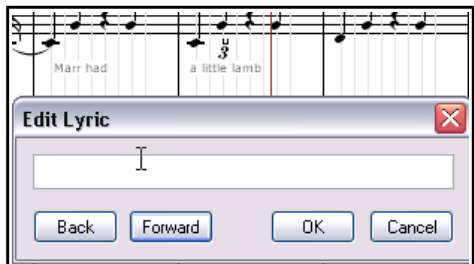
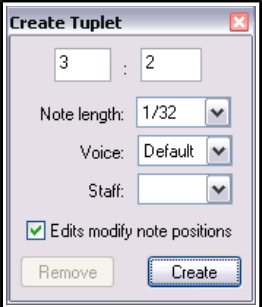

General editing task	Method
<p>Dynamics</p>	<p>Click on the staff to move edit cursor to required position. Right-click and choose Dynamics from the menu.</p> <p>This causes a flyout menu to be displayed, from which you can make any of a number of choices, such as:</p> <p>Crescendo (gradually increase volume) diminuendo (gradually reduce volume) pppp (as softly as possible), ppp (very, very softly), pp (very softly), p (softly) mp (mezzo piano, moderately soft), m (mezzo, moderately), mf (mezzo forte, moderately loud) f (forte, loudly), ff (fortissimo, very loud), fff, (very, very loud) ffff (as loud as possible).</p> <p>An example of how this is displayed is shown here. These notations are performance instructions only: they do not affect the MIDI data in the file.</p> 
<p>Insert text above score</p>	<p>Right click at required location, then choose Text/Custom and Enter text... from menu. Type text and press enter. To edit existing text, right click over it and select Text, Enter text... from menu. To remove, right-click and choose Remove.</p>
<p>Change a dynamic notation</p>	<p>To change a dynamic notation from one menu item to another (e.g. from pp to ppp), right click on the notation and make your selection from the menu.</p> <p>To change a notation from a menu item (such as pp or ff or crescendo) to text, double click on the notation, type the text and press Enter.</p>
<p>Insert custom notation</p>	<p>From the context menu choose Text/Custom, then Custom Notation, type a name in the Name box, select a symbol and click OK. Your named custom notation is also automatically added to the Text/Custom menu for future selection.</p> 
<p>Extend or shrink a crescendo or diminuendo</p>	<p>Hover your mouse over the start or end of the item, so that the mouse cursor changes to a double-headed arrow. Click and drag left or right, as required.</p>

Up and Running: A REAPER User Guide v 7.31

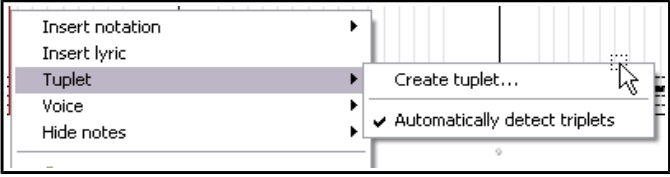
General editing task	Method
Remove notation	Click on the notation, press Delete key.
Move a notation or lyric	Hover your mouse over the middle of the item, then click-hold-drag to drag and drop the item to its required position.
Insert a lyric	<p>Click on the staff to move the edit cursor to the required position. Right click and from the context menu choose the Lyrics command. Type your text and click on OK.</p> 
Remove lyrics	Click on existing lyric text, press Delete key.
Edit lyrics	<p>Right-click over text to open text window. Make your changes and press Enter. You can also drag and drop to move lyrics.</p> <p>Lyrics can also be edited in event list mode (as, of course, can other events).</p> 
Insert sequential lyrics	<p>Type the first lyrics in the Edit lyric box, then click on Forward. With the cursor in the edit box, click Forward to move forward as required, then type the second part of the lyrics in the box. Repeat as needed, then click OK.</p> <p>The Back button can be used to move back thru your lyrics, for example to edit them.</p> 
Create tuplet	<p>A tuplet is an irregular rhythm that involves dividing the beat into a number of subdivisions which differ from those usually allowed by the time signature. To insert a tuplet, first position the edit cursor, right click and choose Tuplet then Create tuplet... from the context menu.</p> <p>This displays the Create tuplet dialog. By default, a triplet (3:2) will be specified, but you can change this. You can select a note length in the range 1/128 to 1/2, and assign a voice (high or low) or accept the default. Staff position may be top or bottom. Your other option is whether to allow note positions to be modified.</p> <p>Click on Create to create a tuplet bracket as a separate item on the staff. The Create tu[plet dialog then becomes an Edit tuplet dialog. You can drag and drop this around as you wish. Click on Apply to "lock" the tuplet, then close the dialog box.</p> <p>Tuplets will impact on the actual MIDI events, e.g. by changing the original note position or length. Notes will snap to the tuplet stops as you edit them.</p> 

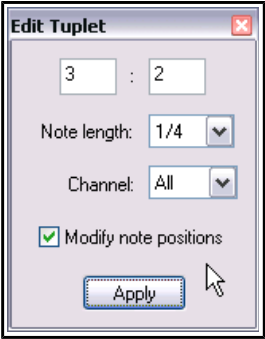
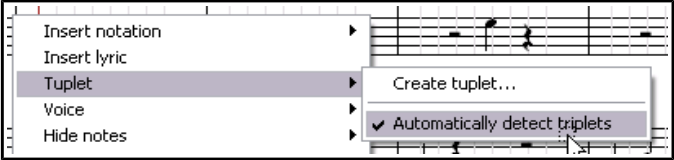
Music Notation and REAPER's Notation Editor

General editing task	Method
<p>Create tuplet (cont.)</p>	<p>For example, a quarter note triplet starting at the beginning of the measure will span the first two beats of the measure and contain a stop at 2/3 beats and a stop at 4/3 beats (each quarter note triplet is 2/3 QN long, because a triplet fits 3 notes in the duration normally taken by 2).</p> <p>You can also alter the tuplet type after it's created: for example, you can switch a quarter note tuplet *(3 QN in the space of 2) to a quarter note duplet (2 QN in the space of 3); the component notes will not change, but the tuplet itself will shorten.</p> <p>More commonly used tuplets include 2:3 (duplet), 3:2 (triplet), 4:3, 5:4, 6:4. For example, a quarter note (crotchet) can be divided into three (triplet), five (quintuplet), six (sextuplet) or seven parts (octuplet). However, the Edit Tuplet dialog allows you to define whatever specifications you choose.</p> <p>Where necessary, rests will automatically be added for missing notes in a tuplet. Rests are indicated by a symbol which represents the length of the pause.</p>  
<p>Move, Change or Edit a tuplet</p>	<p>To move a tuplet, simply drag and drop to the required position.</p> <p>To change a tuplet, right-click on the tuplet, choose Edit tuplet... from the menu, make your changes to dialog box settings and click on Apply.</p> 
<p>Remove a tuplet</p>	<p>To remove a tuplet, click on the tuplet and press Delete. It can also be deleted using the Remove button in the Edit tuplet dialog.</p>
<p>Understand and manage tuplets</p>	<p>If the option Automatically detect triplets is enabled, then triplets will be auto-detected. Auto-detected triplets will be displayed in gray. If you move or alter an auto-detected triplet (not the component notes, but the tuplet bracket itself) it will remain until you manually delete it.</p> <p>Right-click on a tuplet to open the Edit tuplet dialog. You can change note length, voice and/or staff position, or use the Remove button to delete it.</p> <p>Tuplets can also be added and attached to note selections as they are inserted. This topic is covered in the next section.</p> 
<p>Pedal notation</p>	<p>Choose Pedal from the context menu for two pedal notation options – Engage pedal and Release pedal. You also have a toggle option to determine whether pedal notations should be displayed.</p>

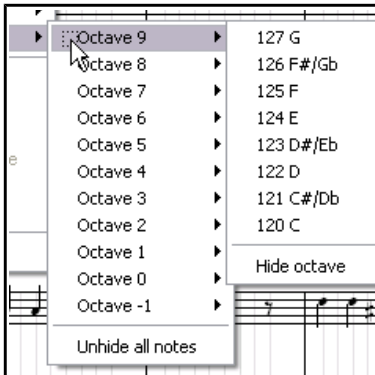
General editing task	Method
Set Voice	<p>The Voice command can be used to select All notes in default voice, All notes in high voice or All notes in low voice.</p>  <p>The method for setting notes to a specified voice is explained in the next table.</p>
Hide Notes	<p>The Hide Notes command can be used to hide notes in any specified octave. It is useful for hiding MIDI key switches or other events not intended to be played as music.</p> <p>Choose this command, then select your required octave from the flyout menu. Next, select a specific note from the list offered, or choose Hide octave to hide all notes in that octave.</p> <p>Repeat the same steps to unhide any specific currently hidden note. To restore the display of all currently hidden notes, choose Unhide all notes from the menu shown here.</p> 
Chords	Use this to access the toggle command Identify chords on editor grid .

14.8 Working with Notes and Note Selections

A number of commands specific to musical notation view are available from this view's own context menu. Select a note (or series of notes) and right-click to display this menu.

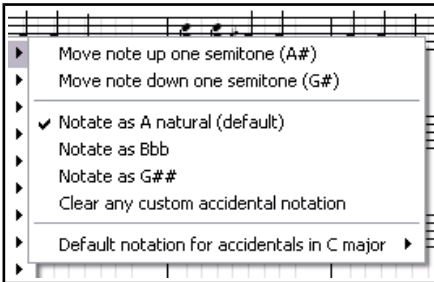

It is well beyond the scope of this User Guide to attempt to teach music theory. Nevertheless, for those that need to learn more, the information in the table below might serve as a starting point by introducing you to some of these terms. These comments are offered for information and guidance only, and are not intended to be comprehensive or water-tight definitions.

Note Option...	Comments ...
Accidentals	<p>Accidentals (sharps and flats) are an instruction to raise or lower the pitch of a note by half a step. Select the note, right-click and select Accidental from the menu. You can then make your choice from the flyout menu. Different values will, of course, be available for different notes.</p> <p>The last of the options on this menu, Default notation for accidentals in C major, can be set to Sharp or Flat.</p> <p>The actions to move the note do actually move the note, not just change the display. If a note can be ambiguously written in either of two ways (for example, C sharp or D flat), the menu will offer a choice of which to display. This will not affect the actual MIDI note, only the notation.</p> 
Stem	This command enables you to over-ride the default stem direction for a note or note selection. Options are Stem up , Stem down , or restore Default stem direction .
Lyrics	Inserts lyric at selected note position. Explained in previous table .

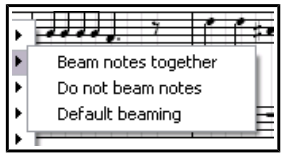
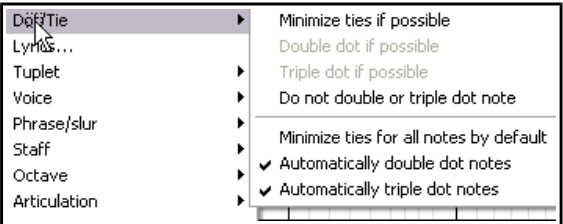
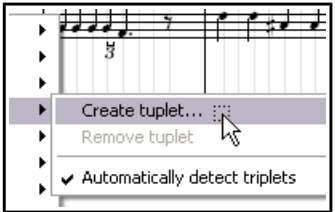
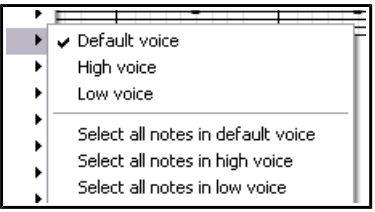
Music Notation and REAPER's Notation Editor

Note Option...	Comments ...
Beam	<p>Right-click on a selected note and choose Beam, then Beam notes together to start beaming on any note. Do not beam notes can be used to remove beaming. This allows you to break up sets of beamed notes to better display the intended rhythm. For example, if four 1/16 notes are beamed together but intended to be phrased as 1+3 then you might wish to start a new beam on the second note. The option Default beaming restores a note selection to the default.</p> 
Dot/Tie	<p>This menu option can be used with a note selection. Right-click over the selection, then you can choose Dot/Tie and Minimize ties if possible to minimize the number of ties in a note selection. There is also an option to Minimize ties for all notes by default.</p>  <p>Options also exist to Double dot if possible, Triple dot if possible and Do not double or triple dot note.</p>
Tuplet	<p>For detailed information about tuplets, see the preceding table General Editing Commands and Actions.</p> <p>Tuplets can also be defined as an attribute of a selection of notes. For example, you could set three notes to be a tuplet, and REAPER will do its best to figure out the correct start, end, duration of the tuplet based on the note positions, even as they changed around.</p>  <p>To do this, make your note selection, choose Tuplet, Create tuplet from the context menu, then enter your required values in the Edit tuplet dialog box.</p> <p>The result of this might not always be to your liking: for this reason, you might prefer to use the method explained in the table General Editing Commands and Actions.</p>
Voice	<p>Notes can be set to High voice or Low voice. To do this, simply make the selection, then right-click over it and choose Default voice, High voice or Low voice from the context menu.</p> <p>Notes in a given voice will be grouped and beamed together, and have their stems point away from the other voice, for visual identification of separate musical lines.</p> <p>You can also select a voice for a newly inserted note in the same way. From Voice on this menu (or from the general editing context menu), you can Select all notes in high voice or Select all notes in low voice.</p>  <p>For high voice notes, articulations will be shown immediately above the notes: for low voice notes they will be shown immediately below the notes.</p> <p>Note also that the Color drop down box includes an option to specify that selected notes should be colored by voice, and that the Voice drop-down determines which voice is assigned to notes as they are inserted.</p>

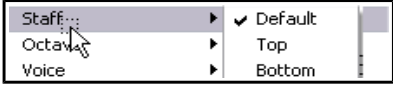
Up and Running: A REAPER User Guide v 7.31

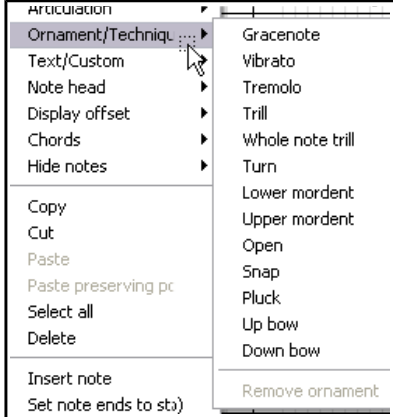
Note Option...	Comments ...
Phrase/slur	<p>Think of a musical phrase as being conceptually similar to a phrase in the English language. Take the example of the old Irish song, Cockles and Mussels. The words "alive alive oh" can be seen to make up a phrase. They belong together, and the end of that phrase would be a suitable place for a very brief pause. Likewise, the musical notes accompanying those words can be said to make up a musical phrase.</p> <p>The curved line that denotes the notes included in the phrase is known as a slur. Shown here is the default technique (normal). You can choose a different slur technique (slide, bend, or hammer/pull) by choosing Phrase/slur, Technique from the notes right-click context menu.</p> <p>To define an actual phrase, first select the notes then choose Phrase/slur, Make phrase/slur from the right-click context menu. A phrase is indicated by a curved line (slur), as shown here. You can edit the phrase as a unit by clicking and dragging on the phrase mark.</p> <p>To select all notes in a phrase, select any note in the phrase, then right-click and choose Phrase/slur, Select all notes in phrase/slur. Phrase/slur, Remove phrase can be used to remove a phrase from a note selection.</p> 
Staff	<p>Use this command to move a note or selection of notes from the treble clef to the bass clef, or vice versa, or to restore its default position.</p> 
Octave	<p>Use this command to move a note selection outside the staff up or down the display by 1, 2 or 3 octaves. This is another command that does not affect the underlying MIDI notes themselves.</p> <p>Notes that are very high or very low (and far away from the staff) can thus be moved closer to the staff without their pitch being affected.</p>
Articulation	<p>Articulations are used to indicate how individual notes within a passage are to be played – for example emphasised (Accent), brief and detached (Staccato).</p> <p>The options on this menu are shown on the right. These are instructions only, articulations do not affect the actual MIDI events. Up to two articulations and one ornament per note are supported.</p> 
Ornament/ Technique	<p>Used to insert an ornamentation on or after a selected note, or each note in a selection. Options available are Grace note, Tremolo, Trill, Upper and Lower Mordent.</p> <p>A grace note is an extra note that is added as an embellishment and which is not essential to the harmony or melody. Grace notes will affect the actual MIDI events.</p> <p>A trill (indicated by the letters tr) is used to provide rhythmic, melodic and/or harmonic interest thru a rapid alternation between two adjacent notes, usually a semitone or tone apart.</p> <p>A turn is a short figure consisting of the note above the one marked, the note itself, the note below the one marked, and the note itself again.</p> 

Music Notation and REAPER's Notation Editor

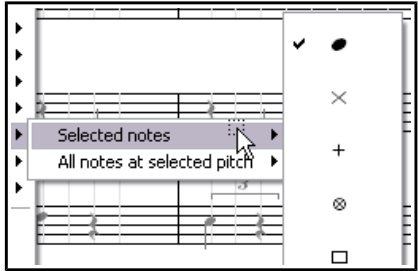
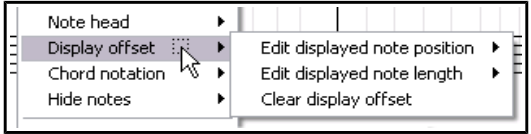
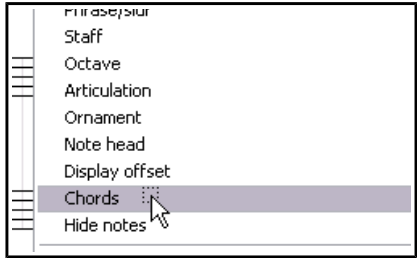
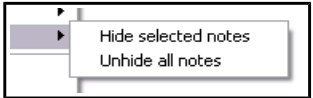
Note Option...	Comments ...
Ornament (cont)	<p>A lower mordent (also known as an inverted mordent) is a single rapid alternation with the note below. An upper mordent is a single rapid alternation with the note above. It is often called simply a mordent.</p> <p>Snap is an instruction to snap the string, so that it snaps back on the fingerboard.</p> <p>Pluck is an instruction to pluck a stringed instrument.</p> <p>Up bow and down bow also apply to stringed instruments: up bow is an instruction to draw the bow upwards or to the left, down bow downward or to the right.</p> <p>An ornament can be removed by right-clicking on the note or note selection and choosing Remove ornament from the context menu.</p>
Text/Custom	Inserts text or custom notation. See General Editing Commands and Actions .
Note head	<p>You can change the graphic used to display your note heads from the standard elliptical symbol to any of a number of alternatives. Right-click over any note or note selection, then first choose Note head from the context menu followed by either Selected notes (only) or All notes at selected pitch. You can then select from a list of about 20 or so choices.</p> 
Display offset	<p>This command is used to modify a selected note (or notes) position or length by nudging left or right. There is also an option to clear an existing display offset.</p> 
Chords	<p>To identify and notate a basic chord, first select the notes then choose Chords from the context menu. If a chord is identified, it will be shown as a menu option. Click on this text to confirm the chord. The chord name will then be displayed in the score.</p> <p>There is also an option to choose Other and enter the chords manually.</p> <p>This menu also includes the toggle action Identify chords on editor grid.</p> <p>Note: As well as being able to select key type (major, minor, etc.) from the MIDI Editor dropdown, you can also select Load... from that dropdown and import your own .reascale file which can be used to define your own scales and chords. The file sample.reascale is included with REAPER.</p> 
Hide Notes	<p>Use this to hide currently selected notes. To unhide hidden notes, choose the Unhide all notes option from the same menu, with any note or notes selected.</p> 
MIDI Editor Edit Commands.	<p>At the bottom of the notes context menu there is a section containing the several MIDI Editor Edit menu commands – Copy, Cut, Paste, Paste preserving position in measure, Select all, Delete, Insert note, Set note ends to start of next note (legato), Select previous note, Select next note and Note Properties. The Note properties... dialog is explained in Chapter 13.</p>

Note: The notations created in musical notation view will also be shown in event list view (see Chapter 13).

For a bound hard copy of the latest version of this User Guide (printed in B&W) go to LULU.com

14.9 Editing Notation Events in Other Views

Notes, of course, can be added, edited and deleted in REAPER's other MIDI Editor views. This also applies in part to dynamics and text/custom events and lyrics.

In event list view, these events are listed in sequence along with all other events (notes, CC messages etc.). Select any dynamic, lyrics/text or track (dynamics) event and use the Delete key to delete it. Lyrics/text events can also be edited – double-click to make the event available for editing. New lyrics/text events can also be entered by right clicking at the required position and choosing **Insert new text event...** from the menu. In piano roll and named note views, a Notation Events lane can be displayed in the CC lane area for lyrics/text, dynamics and tuplets. These events will be displayed as vertical bars which can be moved (click and drag), deleted (delete key) or edited (double click). Right-click in the event lane at the required position to enter a new dynamic, text or custom notation event.

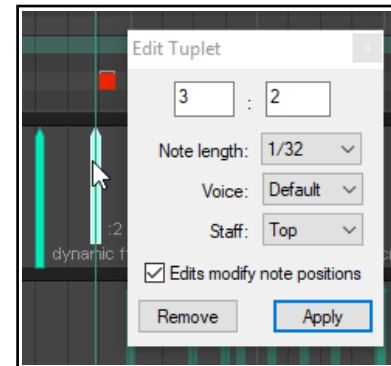

14.10 Exporting MusicXML and PDF Files

It is currently not possible to print your musical notation score from within REAPER. However, you are able to export your score in MusicXML format, which can be read by Finale, Sibelius, MuseScore, Forte, Cubase and many other programs. REAPER also supports export in .PDF and .XML and .MXL (compressed .XML) formats:

1. Open the score in REAPER's MIDI Editor and select musical notation view.
2. From the menu, choose **File, Notation: Export (PDF, MusicXML)**
3. Accept the default directory offered, or navigate to another of your choosing. Select file type (.pdf, .xml or .mxl) and type a **file name**. Specify page width and, optionally, author.
4. Select **score-partwise** or **score-timewise** (see note below).
5. Click on **Save**.

The difference between partwise and timewise lies in the priorities that are applied in arranging part and measure elements. If a score contains more than one part elements, each of which contains one or more measure elements, then score-partwise organises the score with part elements at the top of the hierarchy. Score-timewise reverses this hierarchy. If you are unsure as to which to use, accept the default settling.

Note that REAPER's MusicXML export and import supports multi-layer music.

14.11 XML Import

You can import an XML file (for example, as might be produced by Finale Notepad) by dragging and dropping the file from Windows Explorer or Mac Finder into REAPER's arrange view. This applies to both normal .XML files and zip compressed .MXL files. When you do this, you will be presented with a number of options:

Expand the MIDI tracks into an equivalent number of REAPER tracks. If not selected, all imported MIDI tracks will go on to one REAPER track.

Import the MIDI tempo map to the project tempo and **Import MIDI markers** (if any) **to project markers**.

REAPER will import the file as an in-project MIDI item. This can be opened and edited in the MIDI Editor like any other.

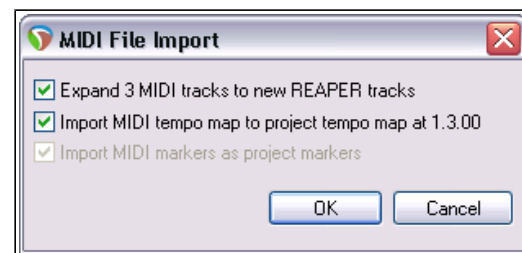

14.12 Making a Notation Editor Toolbar

If you've used other notation editing software, you might think that REAPER is missing something – i.e. a dedicated notation toolbar. That's because you are able to start with a blank canvas and construct your own, adding those commands, actions and options that are most important to you.

Exactly how to do this is explained in [Chapter 15](#). If you search the [MIDI Editor's action list](#) you should be able to find what you want. Especially useful might be a whole stack of actions for inserting notes, advancing the cursor or editing notes, using the current note length division type.

15 Customization: Actions, Mouse Modifiers, Menus and More

15.1 Introduction

Customization is the key to unlocking REAPER's real power and making the program work for you, for example by creating your own actions, assigning your own shortcut keys and customizing mouse modifiers.

- **Actions.** REAPER makes extensive use of keyboard shortcuts. It also has a library of hundreds of actions that you won't find on any of its menus. You can string whole sequences of these actions together to make your own custom commands which can then be triggered off by a single keystroke. This document uses PC (Windows) shortcut keys: Mac users should refer back to [Chapter 1](#) if you are unsure of which equivalent keys to use.
- **Mouse Modifiers.** REAPER uses the mouse extensively, for example for moving and copying media items and making time and loop selections, and in many different contexts. These can be edited and redefined to suit your own workflow.
- **Menus.** Most REAPER menus can be edited to suit your own requirements. You can move to the top the commands most important to you. You can hide the ones you never use. You can even add your own custom actions and commands to these menus!
- **Toolbars.** REAPER's toolbar might not be much to look at, with its lonely collection of just fourteen tools. Did you know, though, that you can add your own tools to it, as well as create your own extra toolbars?

These are the topics that will be covered in this chapter.

15.2 REAPER Actions Essentials

The Actions List and its editor (shown right) are opened by choosing the **Actions** command from REAPER's main menu, then **Show action list...**, or simply by pressing the **?** Key.

Before we look inside REAPER's Action List Editor to explore the world of [shortcut keys](#), [custom actions](#), [control surface assignments](#) and more, it's worth taking stock of a couple of useful resources that are available to you.

Help, Key bindings and

mouse modifiers (from REAPER's main menu) opens your default web browser with a list of all current keyboard shortcut and mouse modifiers. This list is searchable and can be printed.

Choose the **Action list as HTML** command from REAPER's **Help** menu to open your default web browser with a list of all of REAPER's many available actions, any of which can be assigned to a keyboard shortcut and/or combined with other actions into your own custom actions. This list is also searchable and may be printed. This information is also contained within the Action List Editor itself, and this editor is searchable.

ReaScript documentation. Just what ReaScript is will be explained [later in this chapter](#). In brief, ReaScript items can be used to add additional functionality to REAPER. A number of sample scripts can be found at, and downloaded from, stash.reaper.fm/tag/Scripts. They need to be placed inside the Scripts sub-folder within your REAPER applications data directory. They can then be selected and executed within REAPER's Actions list editor by clicking on the **Reascript Load** button.

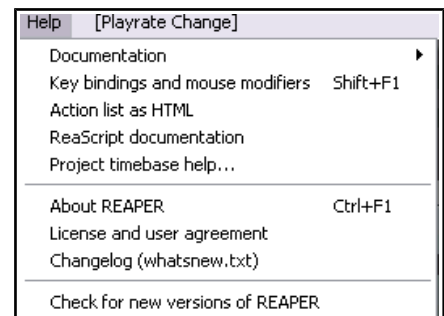
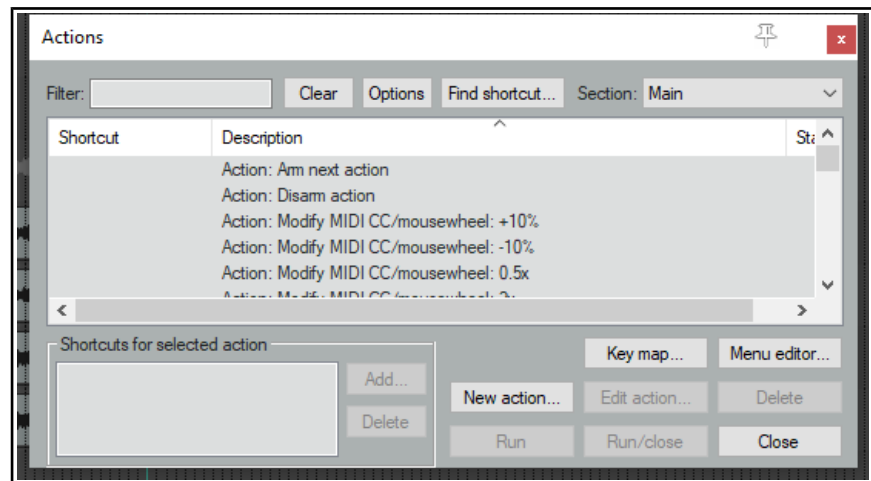

15.3 The Action List Editor Environment

You'll get more out of REAPER's Action List Editor (shown below) if before trying to use it you take a little time getting to know its interface, its structure and how you can navigate it.

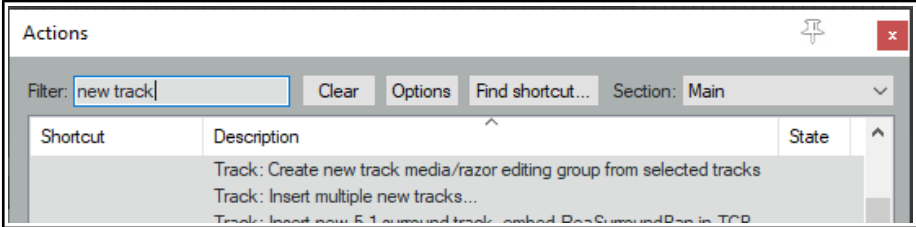
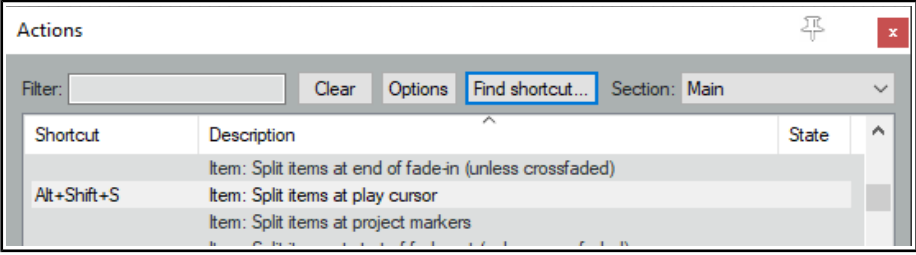
Item	Comments
<p>Filter <i>See also section Using Search Filters for more advanced options.</i></p>	<p>You can filter the list of displayed actions using any text string or strings that you like. For example, in this screen shot the list has been filtered to show only those actions that relate to new tracks:</p>  <p>Notice that one of these actions – Track: Insert new track – already has a shortcut (Ctrl T) assigned to it.</p> <p>Boolean search terms are supported. For example, you could search for any of these: delete OR remove OR clear insert (item OR media) (spaces before and after parentheses) properties (take NOT channel) (spaces before and after parentheses)</p> <p>Notice that where an existing keyboard shortcut exists it is shown to the left of the action. For example, the ! Key is used to toggle the action View: Expand selected track height, minimize others. Similarly, you can see that Ctrl Shift Mousewheel can be used to adjust the height of any track selection.</p> <p>Note: In the actions list, the terms "Ruler" and "Timeline" are synonymous.</p>
<p>Clear</p>	<p>The Clear button clears any current filter and restores all actions to the list.</p>
<p>Finding assigned shortcuts</p>	<p>The Find shortcut... button is used to see if a particular keyboard shortcut has already been assigned to any action. Click on this button and you are prompted to type a key or move a MIDI controller. We'll come to MIDI controllers later in this chapter. If the key is already in use, its assignment will be displayed (see below).</p>  <p>In this example above, we have searched to see if an assignment exists for the letter s. For this kind of search, you should only type in upper case if you really are searching for the combination of Shift with the letter. For example, in this case, a search for Alt Shift S would have produced Item: Split item at play cursor.</p> <p>You can also use the search filter to search more generally for existing shortcut assignments. For example, typing alt+shift in the filter box would list all shortcuts which include both the alt key and the shift key.</p> <p>This can be handy to help you establish (by elimination) which keyboard combinations are and are not currently in use.</p>

Customization: Actions, Mouse Modifiers, Menus and More

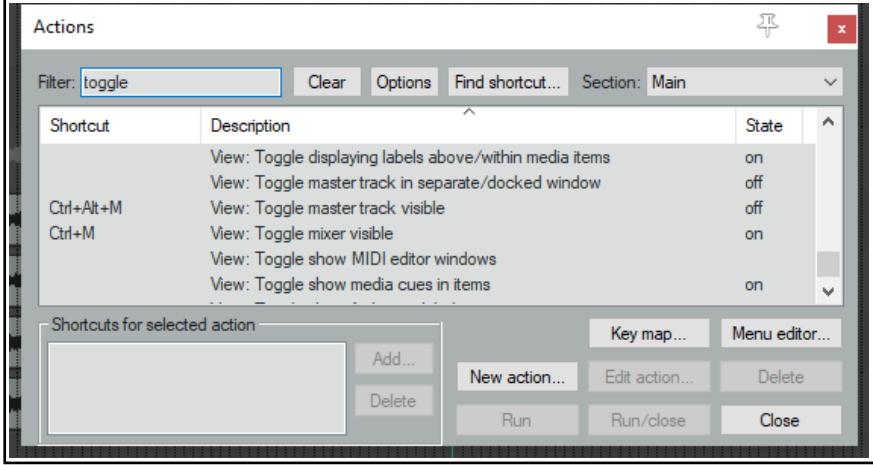
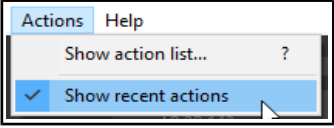
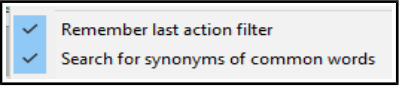
Item	Comments
<p>Column headers/ Sort keys</p>	<p>The State column indicates for toggle actions whether their status is on or off. By default, actions are listed in alphabetical order of their description. You can click on the Shortcut column header to sort instead on current keyboard assignments with special characters and numbers at the top of the list (see below).</p>  <p>Click on the column header again to reverse the sort order. Click on Description to sort them back into alphabetical order.</p>
<p>Sections</p>	<p>The Action List is divided into a number of sections (or contexts). You can assign the same keys to different actions in different contexts – for example, in REAPER’s Main section S is used to split an item. This can be assigned to a different action in, say, the MIDI Editor. This is explained in more detail below.</p>
<p>Run</p>	<p>An action can be executed within the action list regardless of whether it has shortcut keys. Select the action, then click the Run button.</p> <p>If the toggle Show recent actions is enabled on REAPER's main Actions menu (right) then any actions executed during your current session will be added to REAPER's Action menu. Closing REAPER, clears these actions from the menu.</p> 
<p>Run/Close</p>	<p>This button is similar to the Run button, the main difference being that after running the selected action it closes the Actions window.</p>
<p>Close</p>	<p>This closes the Actions window.</p>
<p>Remember last action filter</p>	<p>When enabled (from the Action window right-click context menu) REAPER will apply your most recent filter next time the Actions window is opened, even in a future work session.</p> 
<p>Search for synonyms of common words</p>	<p>When enabled (from the Action window right-click context menu) REAPER will include common synonyms with your search filter. For example, a search for “display” would also find actions that include “show”. If you wish to define your own synonyms you will need to customize a language pack with a section “actionlist_synonyms.”</p>
<p>Show action IDs</p>	<p>This toggle option (from the right-click context menu) shows/hides a column displaying REAPER's action IDs.</p>
<p>General</p>	<p>The Action window exhibits the basic characteristics of other REAPER windows. For example, you can use the pin symbol (top right) to keep it on top, or you can dock it in the docker (from the right-click context menu).</p>

15.4 The Actions List Context Menu

The Actions window right-click menu (shown here) includes three options for managing custom actions/ReaScripts: **Edit**, **Delete** or **Duplicate**.

There are two commands to **Copy selected action command ID** and **Copy selected action text**. There are options to **Arm selected action** and **Disarm actions**, **Remember last action filter** (when the list is closed and later reopened), **Search for synonyms of common words** and/or **Close after action on double-click/enter**.

Search for synonyms of common words lets your search be more flexible. For example, a search for **delete take** would find actions whose description include *delete take* or *remove take*.

The next two actions are mainly to assist script writers and developers. These are **Show command IDs**, **Show ReaScript paths**.

Finally, there are the toggle actions to **Close (window) after action on doubleclick/enter**, **Dock Action window in Docker** and **Close window**.

Above the actions list there is also an **Options** button which gives you direct access to five of the most commonly used of these commands:

Remember last action filter, **Search for synonyms of common words**, **Show command Ids**, **Show ReaScript paths** and **Close after action on doubleclick/enter**.

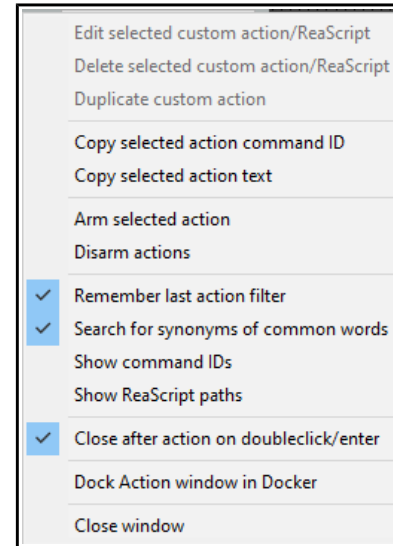

15.5 Creating a New Keyboard Shortcut

In this next example, we will create a new shortcut. Let's take as an example **Solo in front**. It can be useful to toggle this on and off when listening to a soloed track. Filter the action list on "front" and you will see that **Options: Solo in front** does not have any shortcut key assigned to it. Likewise, if you use the **Find shortcut ...** button to search for **q**, you should find that this letter does not have any action currently assigned to it.

If you try to assign a key that is already assigned elsewhere, you will see a message similar to that shown here (right). You would then choose whether to change the assignment for this key or leave it as it is.

Example

1. Choose the **Actions, Show action list ...** command.
2. Click in the **Find shortcut ...** window. Type lower case **q**. You should see a message **Shortcut not found**. This keystroke is available. Click on **OK** to close this message box.
3. In the **Filter** box type **front** then from the list select **Options, Solo in front**.
4. Click on the **Add** button to open the **Keyboard/MIDI/OSC Input** box. When it appears, untick the option **Automatically close window on key/MIDI input**. This makes it less likely that you will assign a wrong key by mistake. Press lower case **q** – you will see **Q** displayed in the **Keyboard or MIDI Input** box (right).
5. Click on **OK** so that the keyboard shortcut is assigned.
6. Close the **Actions** window. You can now use the shortcut key lower case **Q** to toggle **Solo in front when listening to a soloed track**.

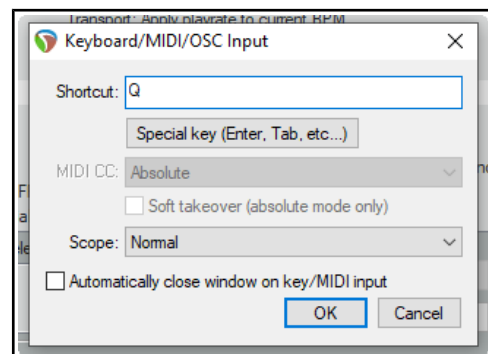
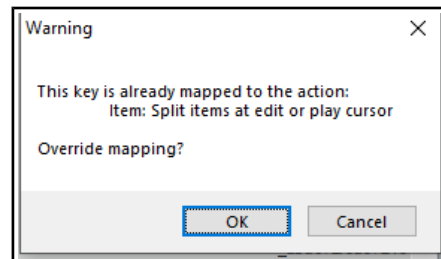

Note: If you are assigning a combination of keys (e.g. Shift Q), then you need to press both keys together, at the same time.

Customization: Actions, Mouse Modifiers, Menus and More

15.6 Global Shortcut Overrides

The **Keyboard/MIDI/OSC Input** window is opened by selecting an action and clicking the **Add** button. This window includes a **scope** option, which allows you to define a keyboard shortcut as global. Defining a shortcut as **global** allows you to use that shortcut in all action list sections. For example, in our Solo in front example, making it global would allow you to toggle this feature on and off when you were adjusting an FX parameters within an FX window, or when you were working in the MIDI editor.

Choosing **global + text** allows the shortcut to be used even when you are editing a text field. Global overrides are shown in the action list with (g) beside them - in this example, this would be **(g)Q** instead of just **Q**.

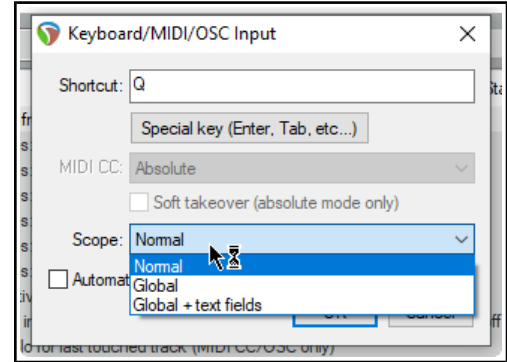

15.7 Removing a Shortcut or Changing a Key Assignment

Removing an existing shortcut is easy. For example, you might like to remove the shortcut that you just assigned to the action **View: Attach/unattach Docker to/from main window**. Follow this sequence:

1. In the Action List, find and select the action from which you wish to remove the shortcut. The current shortcut(s) will be displayed just below the list. (right).
2. Click on the shortcut shown in the window (in this example, **Q**).
3. Click on the **Delete** button. The shortcut will be deleted.

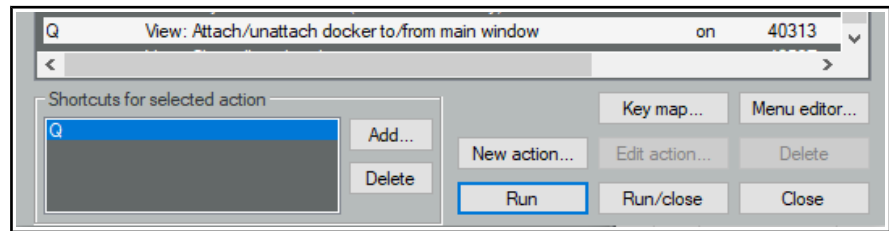

The procedure for changing an existing key assignment combines the two techniques of creating a new shortcut and removing an existing one. Let's take as an example assigning the **Up** and **Down** arrow keys to the actions **Track: Go to previous track** and **Track: Go to next track**, instead of **Ctrl Alt Up** and **Ctrl Alt Down** (the default assignments).

1. Find and select the action **Track: Go to previous track**.
2. In the displayed list of shortcuts, select **Ctrl Alt Up** (right).
3. Click on **Delete** to delete this shortcut.
4. Click on **Add...** to display the **Keyboard or MIDI Input** window.
5. Press the **Up** arrow (see right), then click on **OK**.
6. When asked if you wish to override the current assignment to **View: Zoom in horizontal**, choose **OK**. You will still be able to use the Plus key to zoom in horizontal.
7. Use the same techniques as at steps as at steps 1. to 6. to change the shortcut key for **Track: Go to next track** from **Ctrl Alt Down** to just **Down**.

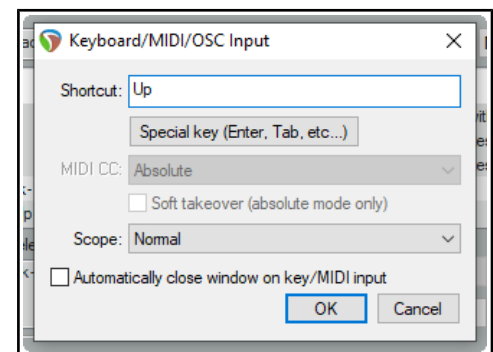
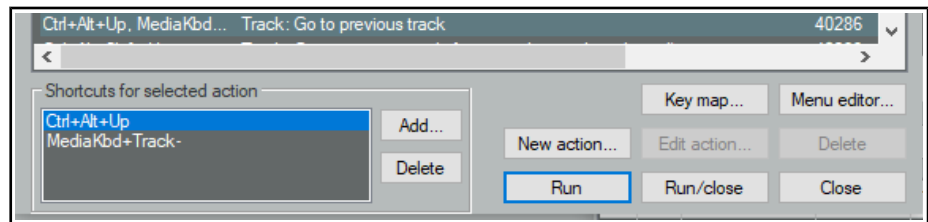

15.8 Action List Sections

The different action list sections can be used in different environments. In most cases, these present you with the actions (for example, when you are recording) that are most relevant to the particular context.

These are **Main**, **Main (alt recording)**, **Main (alt-1 thru Alt-16)**, **IMedia explorer**, **MIDI editor**, **MIDI event list editor** and **MIDI in-line editor**.

Having separate sections for different environments lets you assign the same shortcuts to different actions in different environments. Various combinations of keys could be used in the MIDI editor to select what is displayed in a CC lane.

That same set of shortcuts could be used, say, in the MIDI Event List Editor to determine which channels are displayed, and, say, in the Media Explorer to browse thru various folders. None of the assignments that you make in any of the other sections will have any impact on keyboard shortcuts in the Main section.

The options for alt-1 to alt-16, however, require further explanation. They allow you to determine keyboard shortcut behavior in various *contexts* rather than *environments*.

No two people's needs are likely to be the same, so let's look at a couple of simple examples. Try not to focus on the actual examples (which might or might not be relevant to you) but rather on the technique.

By default **S** will split selected media items or, if no item is selected, all media items, at the current cursor position. There will be times when this might be what you want, but other times, perhaps at a certain stage of tracking, when you might prefer to use **S** to solo/unsolo a currently selected track.

Likewise, **at that** same stage of your project you might not yet be ready to worry about markers and will prefer to use **M** to mute/unmute a currently selected track, rather than create a marker.

Example

You will want to create a shortcut for switching between the different shortcut sections, and also override the REAPER's default settings where necessary. With any project open, this is how this could be done:

1. Open the **Actions** window.
2. Find the action **Main action section: Toggle override to alt-1**. Select it.
3. Click the **Add** button, press **Alt 1**, then **OK**, and **OK** again to **Override mapping**.
4. With the **Actions** editor open, from the section drop down list select **Main (alt-1)**.
5. Find the action **Track: Toggle solo for selected tracks**.
6. Click the **Add** button, type **s** in the Shortcut edit box, click **OK**. Again click **OK** to **Override mapping**.
7. Find the action **Track: Toggle mute for selected tracks**.
8. Click the **Add** button, type **m** in the Shortcut edit box, click **OK**. Again click **OK** to **Override mapping**.
9. You could continue to define more custom shortcuts for this section, but we'll leave it at that for now.
10. Make sure the **Main** section is selected. Close the **Actions** editor.
11. Press **m**. A marker will be inserted. Press **Ctrl z** to undo. Select any track.
12. Press **Alt 1**. Now press **m**. The currently selected track will be muted. Press **m** again to unmute.
13. Press **s**. The track will be soloed.
14. Press **v**. A volume envelope is added – this action has been passed through from the main section.
15. Press **Alt-1** to restore the main action list.

Tip: You can create custom icons for actions that alternative keyboard sets and add them to your toolbar. A single mouse click would then be all that was needed to toggle these sets on and off.

Note: In the above example, we have defined the keyboard shortcut **Alt 1** to toggle keyboard shortcuts between **Main** and **Main (alt-1)** but we don't seem to have added this definition in the **alt-1** section as well. This is because any and all keyboard **Main** section shortcuts that are *not* defined in an alternative section are automatically passed thru to the alternative sections. In this case, for example, **Ctrl S** in the **Main (alt-1)** section would still save the project, **Ctrl Z** undo, and so on.

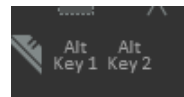
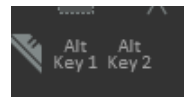
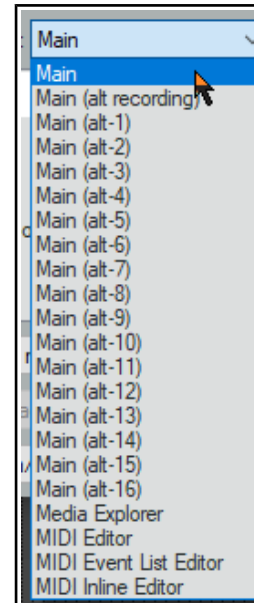

Customization: Actions, Mouse Modifiers, Menus and More

15.9 Deprecated Actions

As you explore the Actions List you might notice that some actions are flagged as “deprecated.” These actions are considered no longer suitable and are not supported. You should not use them. The main reason they remain in the Actions List is so that existing custom action macros which use these actions will not be broken.

15.10 Keyboard Shortcuts for Recording

In this section you will be shown how to create keyboard shortcuts to use when recording. In this simple example you will create two keyboard shortcuts specifically for use when you are recording.

You will have noticed that when you stop recording, REAPER by default prompts you to confirm whether you want to save or delete the new media items. The Main (alt recording) section of the Action List gives you the opportunity to bypass this prompt by assigning keyboard shortcuts for those options that you use most often – **Save All** and **Delete All**. As with the earlier examples, it is only an example. You'll probably find the exercise worth completing even if you don't want to keep these keyboard shortcuts assignments.

1. In the Actions List, select the section **Main (alt recording)** – see right.
2. In the filter box type **stop save**. You should see the action **Transport Stop (save all recorded media)**. Select this action.
3. Click on **Add ...** and type lower case **S** then click on **OK**.
4. Clear the filter box, then type in it: **stop del**
5. Select the action **Transport: Stop (DELETE all recorded media)**.
6. Click on the **Add** button then type lower case **D** to assign this shortcut to the letter D. Click on **OK**.
7. Clear the filter box again. Close the **Actions** window.
8. Make sure that the option to **Use alternate keyboard section when recording** is enabled. You'll find this under **Options, Preferences, General, Keyboard/Multitouch**.
9. Click on **OK** to close the Preferences window.

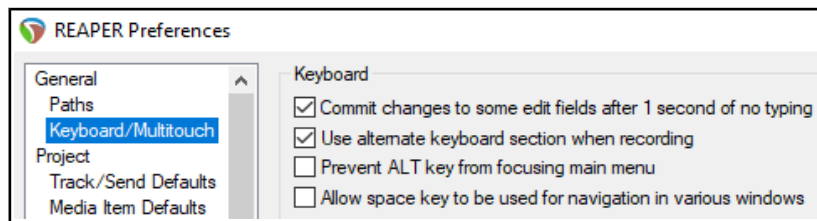
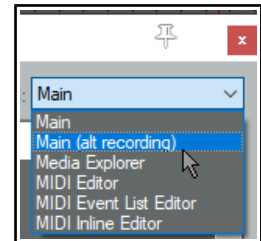

From now on whenever you are recording, you will have the option of using the shortcut keys **S** or **D** to stop recording, automatically saving or deleting the newly recorded media items. You can still use **Enter** if you wish to be prompted. Remember too that when you are not recording, the keys **S** and **D** will revert to their normal functions. For example, **S** can still be used to split media items when working in arrange view.

Tip: If you wish, you can assign macros such as these to an external device such as a keyboard pedal. We'll look at this when we look at Using a Control Device with REAPER.

15.11 Keyboard Shortcuts for the MIDI Editor

Editing is one area where assigning actions to shortcuts can be especially useful, and nowhere more so than when you are using the **MIDI Editor**. Take the trouble to familiarise yourself with the contents of the MIDI Editor section of the Action List and you should be well rewarded. Notice also that there are separate sections for the MIDI Event List Editor and the MIDI Inline Editor.

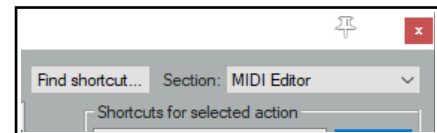

The method of assigning shortcuts to actions, changing or removing existing assignments, etc. is the same as that used in the Main section. Below are listed some examples of actions that you might find useful when working in the MIDI Editor. Special thanks go to Susan G for compiling these lists.

The method of assigning shortcuts to actions, changing or removing existing assignments, etc. is the same as that used in the Main section. Below are listed some examples of actions that you might find useful when working in the MIDI Editor. Special thanks go to Susan G for compiling these lists.

To do this

Channels Management

Specify a channel for new notes and events
Show all or specified channels
Change the channel for selected notes

Use an action such as ...

Action: Set channel for new events to 01 ...1 6
Channel: Show all/only/toggle channels 01 ... 16
Edit: Set notes to channel 01 ... 16

Up and Running: A REAPER User Guide v 7.31

Managing Notes

Insert notes of a specific length
Make notes legato
Transpose notes
Adjust note lengths slightly
Adjust velocities
Display only notes matching specified criteria

Insert note [range from 1/128 to 1/2 to whole note]
Set note ends to start of next note
Edit: Move notes up/down one octave/semitone
Edit: Lengthen/Shorten notes one grid unit/pixel
Edit: Note velocity +/-01, 10
Filter: Toggle filter on/off

Cursor/Grid Management

Advance the cursor by a note value
Move the cursor by specific amount
Change the grid divisions

Cursor: advance ... [range from 1/128 ... to whole note]
Edit: Move edit cursor right/left by grid/measure/pixel
Grid: Multiply grid size by... or Grid: Set division to...

Passing keys thru to main window

If you wish a shortcut keys to perform the same functions in the MIDI Editor as in arrange view, you can assign the action **Pass through key to main window** to those keys.

For example, in the main window, the keys [and] will perform the actions to go to the previous/next marker. By assigning **Pass through key to main window** to each of these actions in turn, you can ensure that these keys will also perform these functions within the MIDI Editor.

15.12 Keyboard Shortcuts for FX and FX Chains

To create keyboard shortcuts for any of your favorite FX (or FX chains), display the FX browser (**View, FX Browser**), then right-click over the FX or chain name and choose **Create shortcut...** from the context menu. You can then define the shortcut in the usual way.

Once assigned, the shortcut can be used to insert the FX into any track or item, or any selection of tracks or items. These shortcuts can also be added to REAPER's **menus** and/or **toolbars**, as explained later in this chapter.

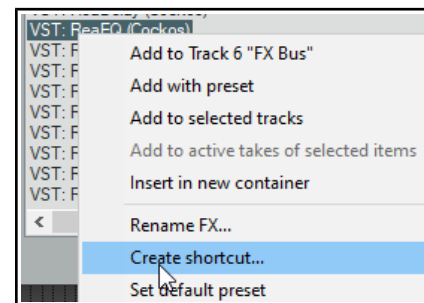

15.13 Assigning Actions to the Mousewheel

One special type of action assignment that you can make is to the mousewheel, optionally also using modifier keys. This way you are able to change the REAPER default mousewheel assignments. This can be useful, for example, if you wish the default behavior of the mousewheel to be to scroll rather than to zoom. Here's a reminder of the default mousewheel assignments:

Mousewheel alone	View: Zoom horizontally
with Ctrl	View: Zoom vertically
with Alt	View: Scroll horizontally
with Ctrl+Alt	View: Scroll vertically
with Ctrl+Shift	View: Adjust selected track heights

Again, the method for changing these is essentially the same as that which you have already used. Suppose, for example, that you wish to use the mousewheel by itself to scroll horizontally.

1. In the actions list (Main section), find the action **View: Scroll horizontally (MIDI/CC relative/mousewheel)**.
2. In the shortcuts list, select **Alt + Mousewheel** and click on **delete**.
3. Click on the **Add** button, then scroll the mousewheel. The text Mousewheel will be displayed, as shown on the right.
4. Click on **OK**.
5. If you wished, you could now use the same method to assign **Alt + Mousewheel** to the action **View: Zoom Horizontally**.

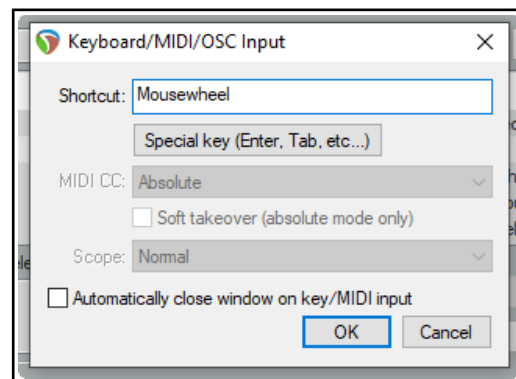

Customization: Actions, Mouse Modifiers, Menus and More

15.14 Exporting and Importing Key Maps

The **Key map** button near the bottom right corner of the Actions window can be used backup or restore any or all of your keyboard assignments. Exported keymap sets are by default saved as .ReaperKeyMap files in the \KeyMaps directory of your \Application Data\REAPER folder.

Import shortcuts/custom actions... Imports keyboard assignments from an existing .ReaperKeyMap file, either all sections or current section only. This might have been exported from a different computer.

Export shortcut keymap file ... Exports all current keyboard shortcut assignments to a .ReaperKeyMap file, either all sections or current section only.

Export selected shortcut key mappings ... Exports only items currently selected to a .ReaperKeyMap file.

Reset all shortcut binding to factory defaults Removes your custom keyboard assignments and restores all REAPER defaults, either for all sections or current section only.

Remove all shortcuts from this section: the nuclear option!

.ReaperKeyMap files can also be included when [exporting/importing configuration settings](#) (see Chapter 22).

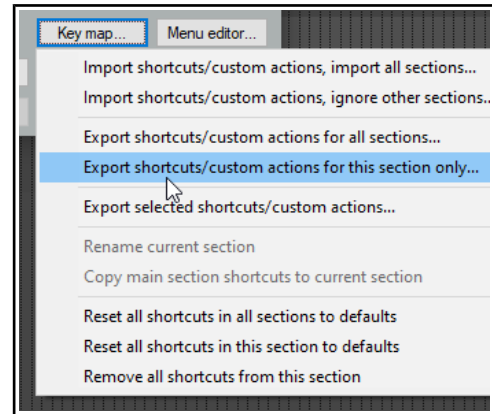

15.15 Creating Custom Action Macros

You can assign an entire sequence of actions to a single keyboard shortcut if you wish. In fact, there is no preset limit to the number of actions that you can assign to a single keystroke or keystroke combination. The process of assigning more than one action to a keystroke is known as creating a custom action, or macro.

As you browse the actions list, you might at first be somewhat puzzled at some of the items that are there. You might wonder, for example, why would anybody need an action for **Item: Select item under mouse cursor** when it is surely easier just to click on the item.

Often with actions like this, the answer is that the real power of these actions comes not from using them on their own, but in combination with other actions.

Managing Custom Actions (Macros) – Summary Table	
In order to do this ...	You do this ...
Create a new macro	Click on New action... button, then choose New custom action... Type a name for your macro.
Add actions to a macro	Drag and drop from action list, or double-click.
Change order of actions	Drag and drop up or down the list.
Remove action from macro	Select action in right hand action list, click on Remove action .
Add macro to main Actions menu	Enable the option Show in actions menu .
Consolidate macro into a single undo point	Enable the option Consolidate undo points .
Show macro as active when running (if added to a toolbar)	Enable the appropriate Show as active option in Create Custom Action dialog.
Save macro	Click on OK .
Assign shortcut key to a macro	Select the macro in the Action List. Click on Add .
Edit an existing macro	Select the macro in the Action List. Click on Edit action .
Run an existing macro	Use shortcut key (if assigned), or select macro in Action List and click on Run option.
Delete an existing macro	Select the macro in the Action List. Click on Delete .

Up and Running: A REAPER User Guide v 7.31

Here's a simple example. Normally, to split an item you need to select it, position the edit cursor at the required position, and then press S. Using a custom action, we can combine this sequence into a single keystroke.

Example

1. In the Actions List, click on the custom actions **New action...** button, then **New custom action**. This opens the **Create Custom Action** window (see below right). Type a name, such as **Split under mouse**.
2. In the list of actions in the left panel find **View: Move edit cursor to mouse cursor**. Double-click on this.
3. In the list of actions shown in the left panel. Find the action **Item: Select item under mouse cursor**. Double-click on this action.
4. In this list of actions double-click on **Item: Split items at edit or play cursor**.
5. Click on the option **Consolidate undo points** to enable it. Click on **OK** to return to the main Action List with your new custom action selected.
6. Click on **Add** and type lower case **c** to assign **c** to your macro. Click **OK**. **Close** the Actions List.
7. Hover your mouse over any media item and press lower case **C**. The item will be split at that point. One of the split items will still be selected. If you don't like this, you can edit the macro.
8. Open the Actions List Editor, find your macro **Split under mouse** and select it. Click on **Edit**. Add to the end of this macro the action **Item: Unselect (clear selection of) all items**. Click on **OK**.
9. Now test the macro again. This time it will split items without leaving anything selected.

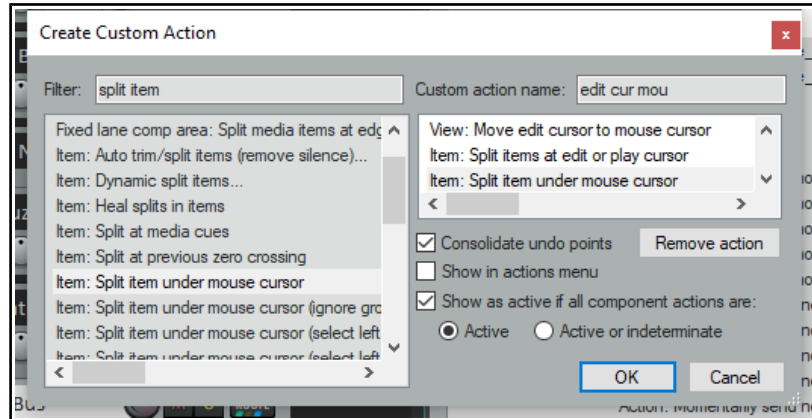

This is just one example of a custom action macro in action. Think about other sequences of actions and commands that you use together ... think actions, think macros! You'll also find plenty of ideas and inspiration on **The Useful Macro Thread** on REAPER's **Q&A, Tips, Tricks and How To** forum – at forum.cockos.com.

15.16 Importing and Loading Scripts

For more advanced programs which go beyond chaining together actions, you can import into REAPER custom scripts that you may have written or obtained (perhaps from the **Reaper Stash** at <https://stash.reaper.fm/tag/Custom-Actions>) and which add extra functionality to the program. Python, EEL and Lua scripts can all be imported. For Windows users, to access actions written in Python, Python will need to have been installed on your computer and ReaScript enabled on the Preferences, Plug-ins, ReaScript page.

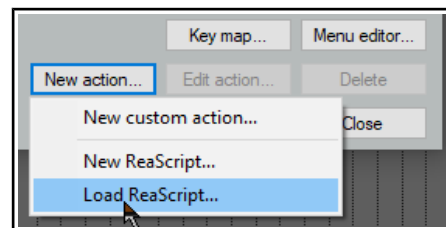

Once you have downloaded and stored your required scripts on your hard drive, you can load them into REAPER by clicking first on the **New action** button, then **Load ReaScript**, then navigate to the appropriate directory, then select the required file(s) and click on **Open**.

The topic of writing scripts is outside the scope of this User Guide, although there is a brief [introduction to ReaScript](#) in Chapter 23. If you are interested in learning more you should visit the REAPER web site, and in particular: www.cockos.com/reaper/sdk/reascript/reascript.php

ReaScript documentation can also be opened from REAPER's Help menu.

15.17 Introducing ReaPack

A useful source of scripts is the **ReaPack** plugin. This allows you to import and install several packages containing any number of scripts that you might find useful. The plugin can be found at <https://reapack.com/>. Instructions for downloading, installing, etc. are at <https://reapack.com/user-guide>.

Customization: Actions, Mouse Modifiers, Menus and More

15.18 Meta Actions

Meta actions enable you to repeat the same macro as many times as you wish without having to keep pressing the same shortcut keys. This technique can be used, for example, to drop a marker at the start of each verse of a song.

REAPER includes two meta action commands:

- Action: prompt to continue, and
- Action: prompt to go to action loop start

Example

Take a look at the example on the right. If you create this custom action macro and assign it a keyboard shortcut (such as **Ctrl Shift K**), then you can use it in this way.

Select any track which is made up of multiple items and position the play cursor at the start of the timeline.

Run this macro. The cursor will move to the start of the first item in the selected track and drop a marker at that point. You will then be asked if you wish to continue to loop this action (see right).

If you press **Enter** or click on **Yes**, the play cursor will move to the start of the next item, insert a marker there, and ask the question again. If you click on **No**, then the execution of the macro will stop.

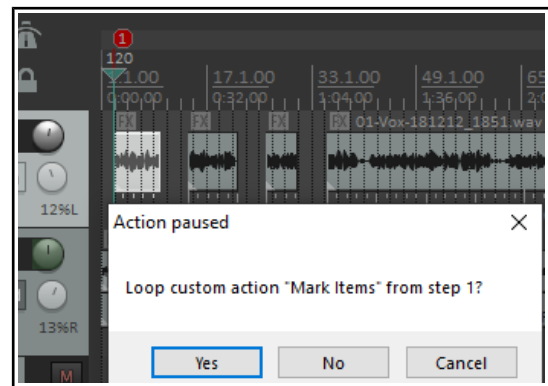
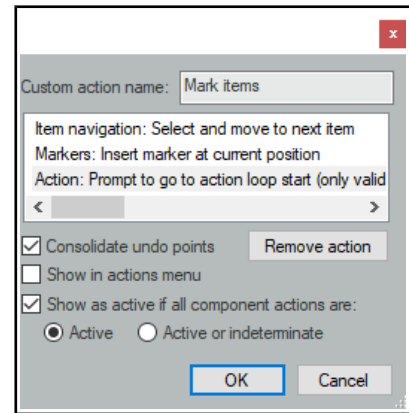

15.19 Mouse Modifiers

We've come across the mouse modifiers page of REAPER's preferences settings several times already. This page is where you can change any of REAPER's default mouse modifier controls and also add more of your own. Some pointers to keep in mind:

- **Modifier keys.** Windows users can use any of these modifier keys, in any combination, for any mousewheel action: **Shift, Ctrl, Alt, Win**
Mac users may use any of these modifier keys, in any combination: **Shift, Command, Option, Control**
- **Contexts.** The Contexts drop down list on the Mouse Modifiers page of your preferences window lists the contexts in which you could use your mouse and for which you could need modifiers (see right). When you select an item from this list, current mouse assignments for that context are displayed.

For most contexts you will find a number of variations, depending upon the exact kind of mouse action being undertaken. For example, separate mouse modifiers can be applied to media items depending on whether the mouse action being applied is a simple left click (which by default selects the item), left drag (which by default moves the item) or a double-click (which by default opens MIDI items in the MIDI editor, or displays media item properties for audio items). Some contexts (e.g. Arrange view) also make middle button mouse actions available.

You aren't going to learn all of these at once, and some of them you may never need. For example, if you never do any work with MIDI then the various MIDI contexts are unlikely to be important to you. Take the time to identify those which you are likely to use the most and think about how you can improve them. The procedure for customizing REAPER's mouse modifiers is as follows:

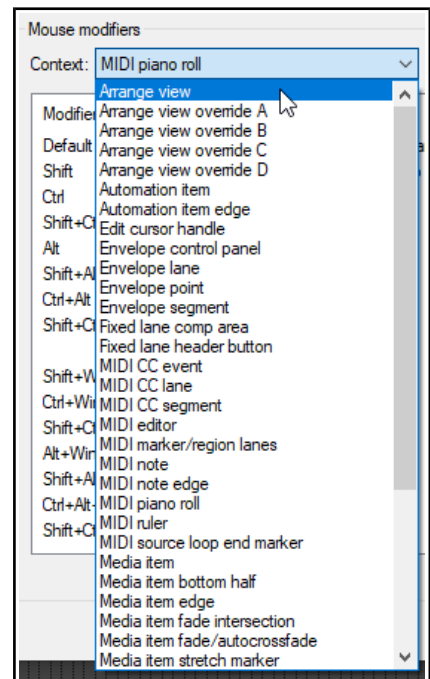

Up and Running: A REAPER User Guide v 7.31

1. Display the **Mouse Modifiers** page of REAPER's Preferences Window.
2. Display the Context drop down list and select an entry from that list. A list of current modifiers for that context is then shown. An example of this is shown here, for **Media item edge left drag**.
3. In the Modifier column, double click on the item that you wish to change. A list will be displayed which shows *suggested* actions that you might wish to assign to that modifier. You now have a number of choices:
 - ✓ Select any item from that list, or
 - ✓ Select No Action to disable that modifier, or
 - ✓ Select the item marked with a bullet to restore the default action for that modifier, or
 - ✓ For some items only (including double-click items), use **Action List ...** to open the Action List editor so that you can assign one of REAPER's actions, or one of your own custom actions, to that context.
4. Click on **Apply** to apply your changes.
5. Repeat steps 1. to 4. as often as needed. When finished, click on **OK** to close the Preferences window.

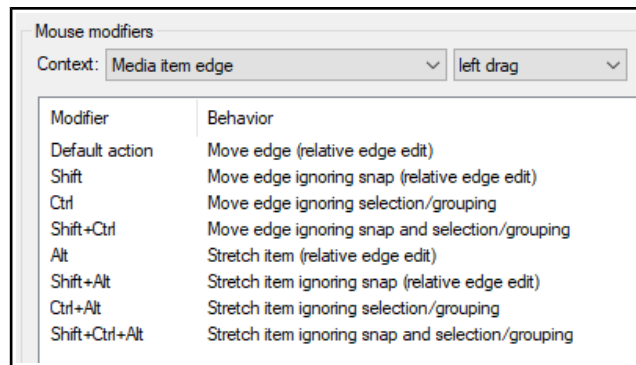

There is a checkbox at the foot of this window for this context that can be used to **Limit edits to source media content for unlooped media items**.

The **Import/Export** button can always be used to **Restore modifiers to factory defaults in this context**.

The examples that follow should help you to understand how REAPER's mouse modifiers work and how to use them. Don't be concerned if not all of these mean a lot to you focus on the techniques:

- Creating empty MIDI items on tracks.
- Slip editing media items.
- Adding FX to media items.
- Toggling mute status of media items.
- Setting and removing loop points.

That's (intentionally) a fairly mixed bag of activities. All of these are examples of activities that can be made easier and/or faster and/or smarter by modifying REAPER's mouse modifiers.

Examples

This exercise will step you thru the above examples in the same order as they are listed.

1. Choose the **Options, Preferences** command, then select the page **Mouse Modifiers**.
2. Select **Track left drag** from the context menu. REAPER's default mouse assignments for pencil drawing copies of items will be shown. **Alt** and **Shift Alt** are currently unassigned.
3. Double click on **Alt** in the Modifier column. A list of possible actions will be shown.
4. In this list, click on **Draw an empty MIDI item** then **Just draw** or **Ignoring snap** (as you wish). This action is now assigned. The small dot shown next to this Action on the list indicates a custom change that you have made yourself.
5. Click on **Apply** to apply the action.
6. Now select **Media item edge drag** from the context list. Let's suppose that we want to make **Move item edge ignoring snap** the new default behavior when clicking and dragging from the media item edge.
7. Double click on **Default action** and select **Move item edge ignoring snap** from the menu. Now double click on the modifier **Shift** and select **Move item edge** from the menu.

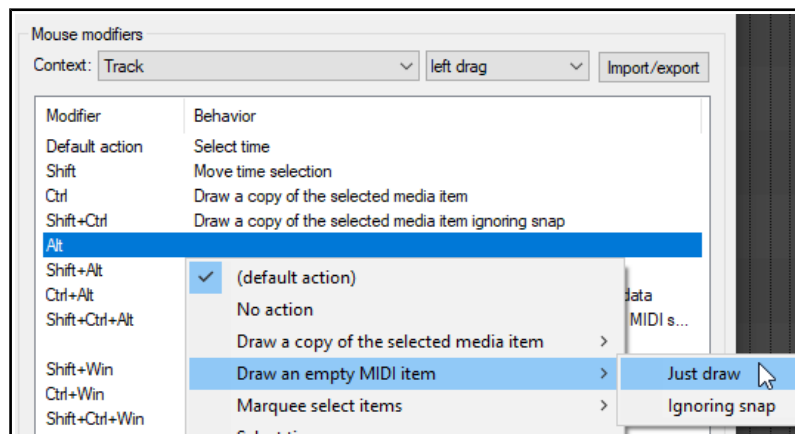

Customization: Actions, Mouse Modifiers, Menus and More

- Click on **Apply**. These two items have now been swapped over.
- Now select **Media item double-click** from the context drop down list. Modifiers for this context will now be displayed. Suppose that we want to create an action which can be used to open the item's FX chain window, and that we wish to assign **Shift Ctrl** for this.
- Double-click on the text **Shift+Ctrl** to display a menu. Click on **Action List ...** to open the Action List Editor. If you have worked thru the earlier examples in this chapter, this will be familiar! Find the action **Show FX chain for item take** and select it. Click on **Select/Close** to return to the Mouse Modifiers window. Click on **Apply**. This action is now your media Shift Ctrl double-click action (see below).
- Repeat this procedure to apply the action **Item properties: Toggle items mute** to the modifier **Shift+Win**. Click on **Apply**.
- Finally, we can add an action to the **Ruler double-click** context so that the **Shift** modifier will remove any current loop points.
- Select **Ruler double-click** from the context drop down list. Double click on **Shift** in the modifier column and select **Action List...** from the menu. Find the action **Loop Points: Remove (unselect) loop point selection**, select it then click on **Select/Close** and then **Apply**.
- Close the Preferences window.

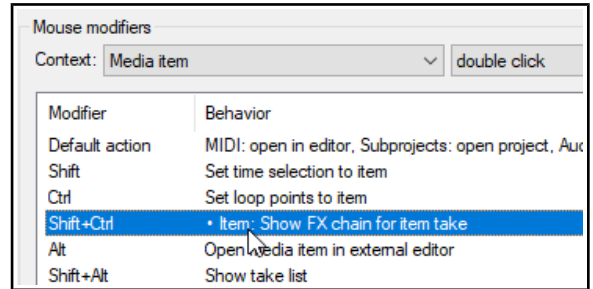

If you do not wish to keep these assignments, use the **Import/Export** button to restore factory defaults.

Remember! When you are assigning actions to mouse modifier keys you are not limited to using REAPER's native actions. Provided that you have installed the SWS extensions you can use any of the SWS actions. You can also use any custom actions that you have created yourself.

Note: When you select a mouse modifier context, in some cases an option relevant to that specific context will be displayed just below the list of behaviors. Look out for these. For example, for both the Track and Media items contexts you can specify whether the item label area (above the media item) should be regarded as part of the media item or as empty space.

Tip for MacOS Users:

Next to the Import/Export button you will find a **Swap cmd/opt** button. This can be used to swap over all **Cmd** button and all **Opt** button assignments for the currently selected mouse modifier context,

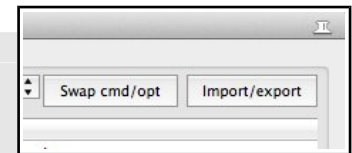

15.20 Saving and Restoring Mouse Modifier Settings

Mouse modifier settings can be saved to and restored (loaded) from REAPER mouse map files using the Import/Export button. Settings can be saved/restored for the current context only, or for all contexts (see right).

15.21 MIDI Editor Mouse Modifiers

Using mouse modifiers in the **MIDI Editor** is a topic that merits a section of its own. Nowhere is this more true than when you are editing MIDI notes and CC events.

A large number of actions are available for use in the MIDI editor.

One example is the **MIDI note left click** context (below). If you

use the MIDI Editor a lot then you should definitely take some time to investigate and to identify which of these actions are most useful to you. For example, you could reassign **Alt** to be used when clicking on any note to erase it. Notice that in addition to the other shown on the menus, you can choose to open the **Action list** and select an action there.

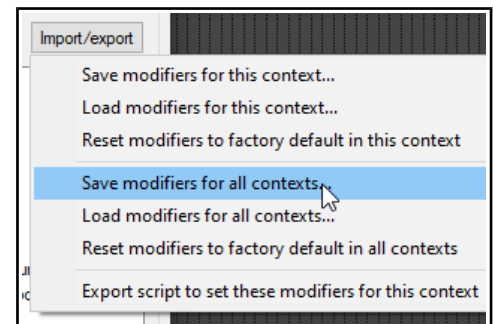

Up and Running: A REAPER User Guide v 7.31

All actions in REAPER's Action List MIDI Editor and MIDI Event List Editor categories (including any custom actions of your own) are available to be assigned as a mouse modifier in most contexts within the MIDI Editor. MIDI Editor mouse modifier contexts include:

- MIDI note left click, MIDI note left drag**
- MIDI note double click**
- MIDI note edge left drag**
- MIDI CC event left drag**
- MIDI CC lane left click/drag**
- MIDI CC event double-click**
- MIDI CC lane left drag**
- MIDI CC lane double-click**
- MIDI source loop end marker left drag**
- MIDI ruler left click, MIDI ruler left drag**
- MIDI ruler double-click**
- MIDI marker/region lanes left drag**
- MIDI piano roll left click**
- MIDI piano roll left drag**
- MIDI piano roll double-click, and**
- MIDI editor right drag.**

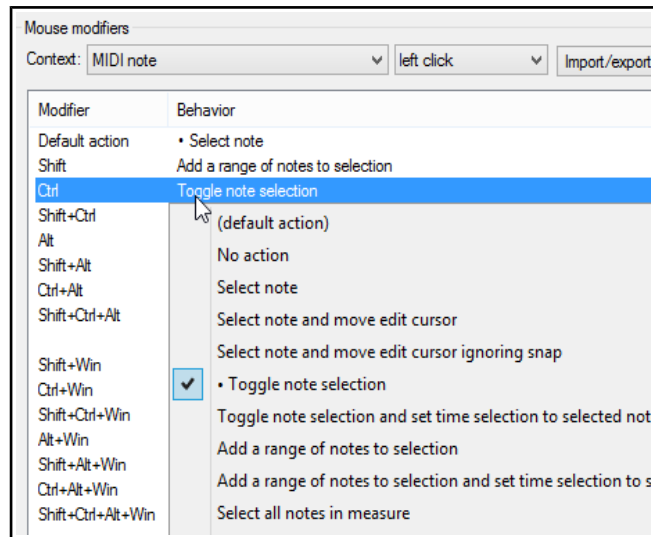

Let's take a brief look at some of these areas in which you can modify mouse behavior within the MIDI Editor.

Shown here are the defaults for **MIDI note left drag**, **MIDI piano roll left drag** and **MIDI ruler left drag**. In many cases separate contexts are available for left click, left drag and double-click behavior. You can define how your mouse behaves when it is being used in any of these contexts.

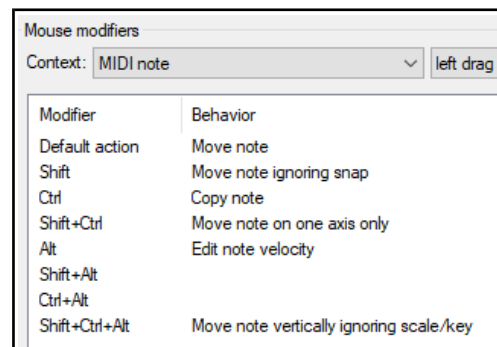

Within most contexts you will find several different types of mouse action. For example, when working with MIDI notes, a different action will be required when (say) dragging a note from when double-clicking on it. Thus, within the Mouse Modifier page of your preferences, you can select not only a context but also a type of mouse action.

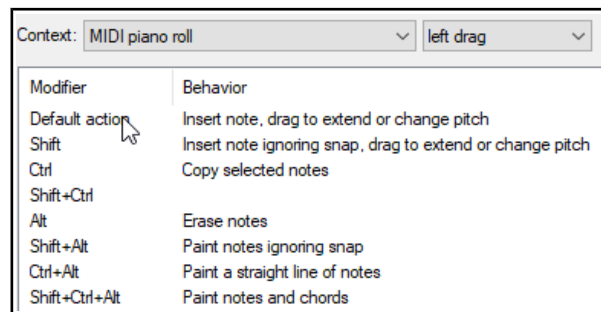

Here are two examples: the default actions for the contexts MIDI note left drag (above right) and MIDI piano roll left drag (right). By default many actions are already defined. For example, simply dragging a MIDI note (or selection of notes) will by default move the note(s), whereas holding Ctrl while you do this will copy them. For example, holding Shift and Alt while dragging a marquee selection of notes will stretch the selection out horizontally so as to arpeggiate the notes.

Simple click and drag in the empty MIDI piano roll area will first draw a note, then extend it as the mouse is dragged. Various keys can be used with this for other actions. For example, holding Ctrl and Alt while dragging will paint a straight line of notes between mouse up and mouse down.

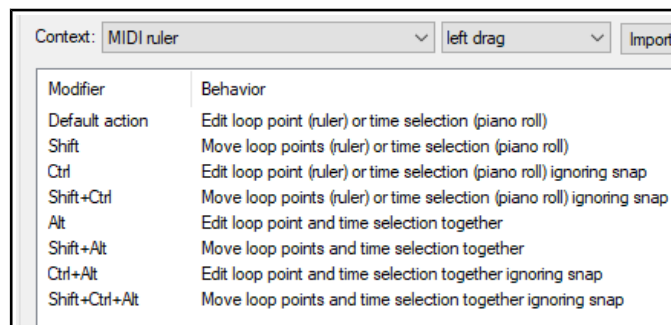

Many key combinations are not assigned. Click on any of these for a list of actions that you can use. You can also use this method to change any existing assignments. Shown right are the default actions which are assigned to the **MIDI ruler left drag** context.

If you use the MIDI Editor a lot, you should take

Customization: Actions, Mouse Modifiers, Menus and More

the time to explore just what is available for the different contexts.

Take the time also to look at the **MIDI editor right drag** assignments. As well as several variations to set marquee behavior (select notes, add notes, toggle selection, etc.) there is also an action using **Ctrl Alt** to select all notes touched while freehand dragging.

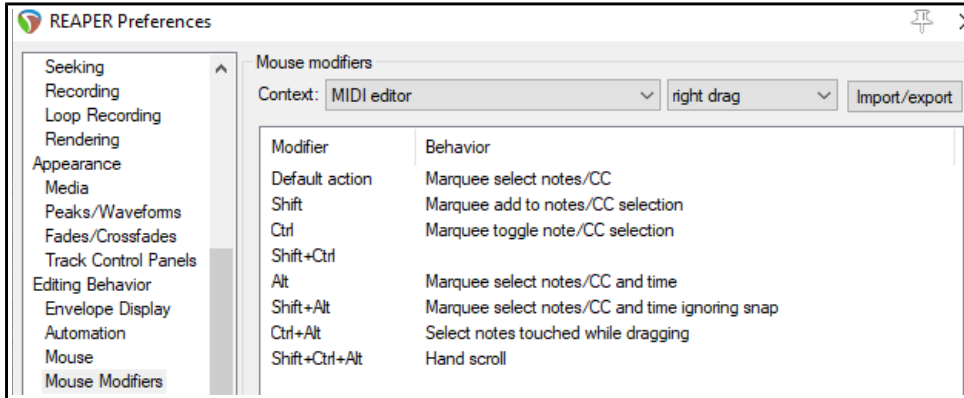

Note:

The **Import/Export** button can be used to export current settings for any context or all contexts to a ReaperMouseMap file, to import a previously saved mouse map file, or to reset all modifiers to factory settings.

15.22 Customizing the REAPER Menus

You can customize REAPER's main menu and many context menus in a number of ways, including:

- Removing from view commands that you never use.
- Changing the order in which commands are listed.
- Adding your own custom actions to an existing menu.

To open and display the **Custom Menu** interface, choose from the main menu the command **Options, Customize menus/toolbars**. This causes the Customize menus/toolbar window to be displayed. By default, it will open with the Main File menu displayed.

The table below summarizes the main tasks that can be carried out within this window.

For Windows and Linux users, the **&** sign displayed before any letter indicates that

when the menu is displayed, that letter can be typed to select that command. On the menu itself, the letter will appear underscored. Thus, in the example shown above, when you display REAPER's main file menu, the letter **N** in **New project...** will appear underscored, and you can therefore type **n** to select this command.

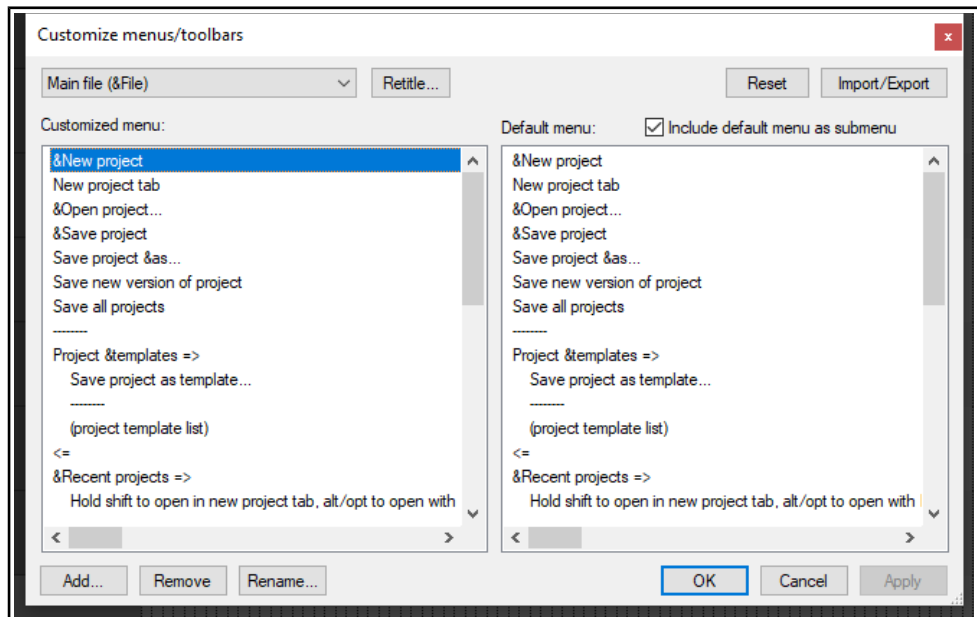

In order to do this you need to do this.
Select a menu for customization	Display the drop down list (top left of window) and select the required menu.
Change the name of a currently selected main menu command	Select the command. Click on the Retitle... button. Type the new name and press Enter .

Up and Running: A REAPER User Guide v 7.31

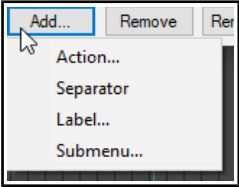
In order to do this you need to do this.	
Select a command or number of commands to be modified	Click on command in the left pane, or use Ctrl click to build a selection.	
Remove command(s) from the currently selected customized menu	Make selection in the left hand column. Right-click and choose Remove from the menu, or click on the Remove button below the customized menu pane.	
Change the position of command(s) on the customized menu (left column)	Either ... in the left column, drag and drop the command or command selection up or down to its required position. Or ... in the left column select the command(s) that you wish to move. Press Ctrl X . Click at the position where you wish them to be placed. Press Ctrl V .	
Copy command(s) from one main level menu to another	Select the first main menu from the menus drop down list. Select the required command(s) and press Ctrl C . Select the second main menu from the menus drop down list. Click at the required position in the customized window (left) pane and press Ctrl V .	
Add a REAPER action or a custom action to the current custom menu as a new command	In the left column, click to select the existing command above which you wish to insert your custom action. Click on the Add button, then choose Action from the menu. Select your item from the list then click on the Select button.	
Rename a command on the custom menu	In the left column, select the command, click on Rename , then type the new name and press Enter .	
Add a separator to the current custom menu	In the left column, click to select the existing command above which you wish to insert the separator. Click on the Add button, then choose Separator from the menu.	
Add a label to the current custom menu	In the left column, click to select the existing command above which you wish to insert the label. Click on the Add button, then choose Label from the menu.	
Add a submenu to the current custom menu	In the left column, click at the position you want the submenu inserted. Click the Add button, then on Submenu . Type a name then press Enter .	
Apply/Save changes made to the current custom menu	Click on Apply button. The dialog remains open until you press OK (to save changes) or Cancel (to lose changes).	
Restore the one or all custom menus to the default settings	Click the Reset button, then choose either Reset Current Menu or Reset All Menus .	
Export the current custom menu or all menus as a ReaperMenuSet	Click on Import/Export , choose Export All or Export Current , then type a name and click on Save .	
Replace the current custom menu or all menus with a previously saved Reaper Menu Set	Click on Import/Export... then select the required menu set file, then click on Open , or drag and drop .ReaperMenu and .ReaperMenuSet files into REAPER from Windows Explorer.	
Include REAPER's default menus with your custom menus	Tick the Include default menu as submenu option (top right of window). This is recommended especially if you are removing any default commands from the menu.	

Customization: Actions, Mouse Modifiers, Menus and More

Example

Suppose that you do a lot of work with markers, and that you would like to renumber markers in timeline order quickly and easily without having to remember a keyboard shortcut. You could add the action to the Ruler context menu. While you're about it, you can also remove the command **Insert empty space in selection** (assuming for the sake of the example that you think you do not need this command). Follow these instructions.

Example

1. From REAPER's **Options** menu, open the **Customize menus/toolbars** window.
2. Display the drop down menu list and choose **Ruler/arrange context**.
3. Click on any one of the commands in this menu – for example **Set selection to items**.
4. Click on the **Add...** button, then choose **Action...** This opens the Actions List Editor window.
5. In the filter box type: **mark renum** – this finds the action **Markers: Renumber all markers in timeline order**.
6. Select this action then click on **Select/close**. The Actions window will close and you will be returned to the Customize menus/toolbars window. This action has now been added to the menu and is selected (see right).
7. With the item still selected, click on **Rename...**
8. You will be prompted for a new name. Type: **Renumber markers** and press **Enter**.
9. To move this up the menu, drag and drop it above **Zoom selection**.
10. Now select the item (lower down the list) **Insert empty space in selection**. Click on **Remove** to remove this from the menu.
11. Make sure you have enabled the option **Include default menu as submenu**.
12. Click on **OK**.
13. Create some markers in this project, out of timeline order.
14. Right-click on the ruler/timeline (see right). Choose **Renumber markers** to renumber your markers.
15. Notice at the bottom of this context menu the item **Default menu: Ruler/arrange context**. This can be used to access the original context menu.
16. If you wish to restore this menu to its original state, open the **Customize menus/toolbars** window again and with the **Ruler/arrange context** still selected, click on **Reset** then **Reset current menu/toolbar to default**. Click on **Save** then **Close**.

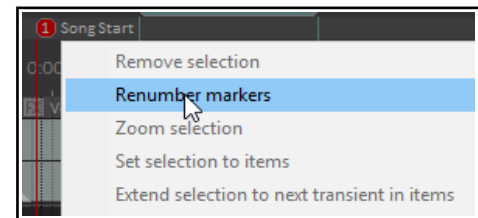
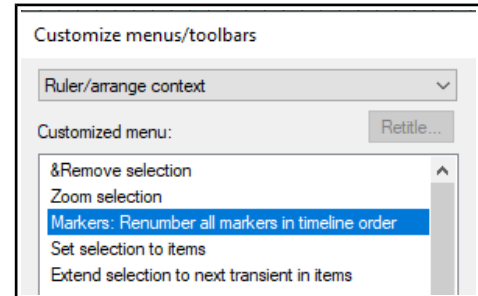

Note: If you are customizing the **Actions** menu, you will need to place any commands that you wish to add above **Show recent actions**, or you can remove **Show recent actions** altogether. If **Show recent actions** is included in this menu it must always be the last item on this menu.

15.23 Customizing the REAPER Toolbars

You can customize REAPER's main toolbar, or any of the 32 other general or 16 MIDI toolbars (by default empty) that are available to you.

Customizing REAPER's main toolbars (including the MIDI Editor toolbars) can help make REAPER work for you to work the way that you would like it to.

For example, you can:

- Remove any of the default icons/commands that you do not wish to be shown.
- Assign a different REAPER command or action to any existing icon.
- Assign a different REAPER command or action to a new icon.
- Assign a custom action or macro of your own to a new or existing icon.

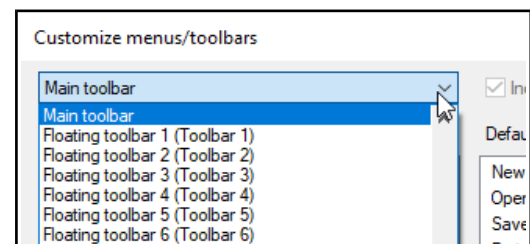

Up and Running: A REAPER User Guide v 7.31

The procedure is similar to that used for menu customization. Make your changes to the existing default toolbar layout thru the **Customize menus/toolbars** dialog box. This can be displayed by right-clicking over the empty area of the toolbar background, or by choosing **Customize menus/toolbars** from the **Options** menu. When the Customize menus/toolbars window is displayed, choose **Main Toolbar** or one of the **MIDI View** toolbars from the drop down list in the top left corner. We'll get to **Floating toolbars** a little later in this chapter.

The table below summarizes the main tasks that can be carried out within this window.

After the table there is an example in which you can add to the toolbar an item of your own.

Purely as an example, we'll use the action **View: Toggle master track visible** for this.

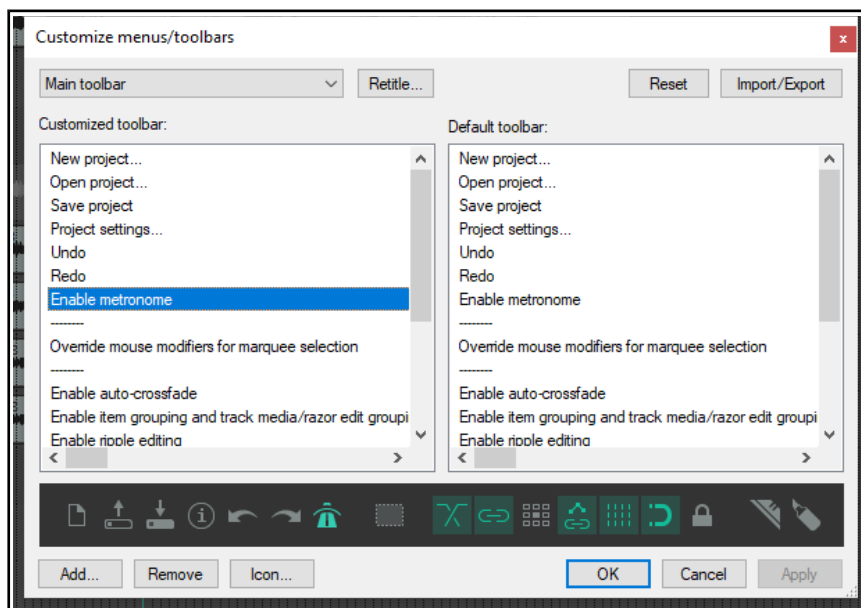

In order to do this you need to do this.
Change the name of a REAPER toolbar	Select toolbar from drop down list. Click on Retitle... , type new name then click on OK .
Remove an item from the toolbar	Click on either the item name in the left panel, or on the icon itself in the display just above the window's command buttons. Click on the Remove button.
Add a new action or command to the toolbar	In the customize toolbar area (left panel) select the item before which you wish to add your item. Click on the Add button to open the Actions window. Select the command, action or custom script. Click on Select/Close . REAPER will add this to your toolbar and assign an icon.
To add a separator space between two toolbar items	In the customize toolbar area, right-click over the second of these items and choose Add separator from the menu.
To change the icon used for any toolbar item (including an item that you have added)	Right click on the icon in the display near the bottom of the Customize Menus/Toolbars window, just above the command buttons. This opens the Select toolbar icon window. Select your required icon, then close the Select toolbar icon window.
Replace a toolbar icon with text	Right click over the item in the list in the left panel. Choose Text Icon from the menu, type the text then click OK .
Change a button's animation status (toggle buttons only)	Right click on button name (left panel) Select Highlight with animation based on toggle state . Choose to animate whether enabled or disabled and select an effect (highlight or blink) See also Animated toolbar icons section.
Change the action assigned to a toolbar button	In the customize toolbar area (left panel) select the item that you wish to change. Right click, choose Change action , then select from the action list and click on Select/Close .

Customization: Actions, Mouse Modifiers, Menus and More

In order to do this you need to do this.
Change the position of an item on the toolbar	Use the mouse to drag and drop up or down the list shown in the customized toolbar list. Ctrl X / Ctrl V may also be used, as can Cut and Paste from the right click context menu.
Close the Customize Menus/Toolbar Window without saving your changes	Click on the Close button. Choose No when asked if you wish to save your changes.
Save the toolbar with your changes	Click on the OK button.
Restore the toolbar to its default status	Click the Reset button. Choose Reset Current Menu/ Toolbars to Defaults from the menu. Click Apply to confirm!
Export the current custom toolbar or all toolbars/menus as a ReaperMenuSet	Click on Export... , choose Export All or Export Current , then type a name and click on OK (see also note below).
Replace the current custom toolbar or all toolbars/menus with a previously saved Reaper Menu Set	Click on Import... then select the required menu set file, then click on Open .(see also note below)

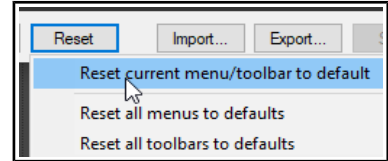

Note: ReaperMenuSets can also be included when [exporting/importing REAPER configuration preferences](#) and settings – see Chapter 22.

Example

The real benefit of this exercise will come from it teaching you a technique, not from the actual example.

1. Right-click over the toolbar area (but not any specific tool) and choose **customize toolbars...** from the context menu.
2. Click on the last item on the toolbar (Enable locking) then click on **Add...** to open the Actions List.
3. Find the action **View: Toggle master track visible**. Select this, then click on **Select/close**. This item will now be added to the list of toolbar items. In the icon display, it will be labelled something like "Tog Mast".
4. Drag this item up or down the list to whatever position you want it to take.
5. If you do not like the text **Toggle Mas** you can right-click over the item in the list and choose either **Change icon** (to select an icon) or **Text icon** (to type a different text label). If you choose **text icon**, you may also select a **Double width toolbar button** option for better text display.
6. Click **OK**. If you don't want to keep this icon, access the customize menus/toolbars window again and simply remove it.

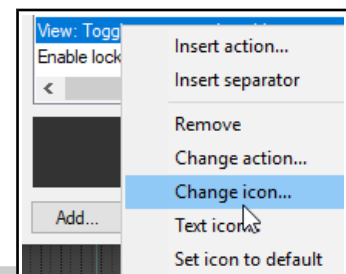
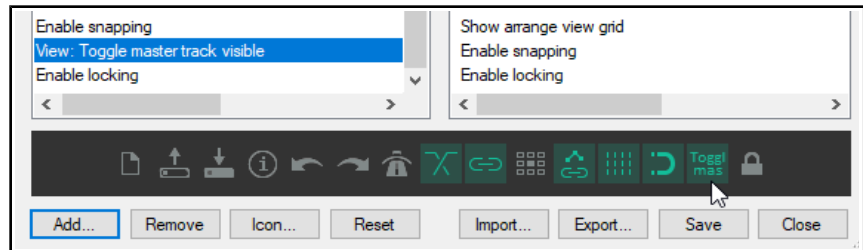
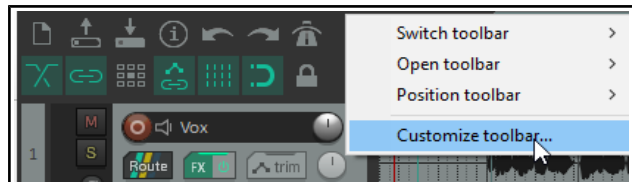

Tip: The command **Position toolbar** can be used to change the position of or float the main toolbar: see section immediately below this one.

15.24 Additional Custom Toolbars

REAPER supports up to 32 general and 16 MIDI only additional toolbars that you can set up to suit your particular requirements. By selecting which commands or actions are added to these toolbars you are able create one click access to your most important commands and actions. To toggle the display of any toolbar, right-click over the empty area of your main toolbar and choose the **Open toolbar** command, then select a toolbar. You may display as many of these toolbars as you wish. By default, each toolbar contains one icon, labelled "Edit Me". To change this, you will need to customize the toolbar (see below).

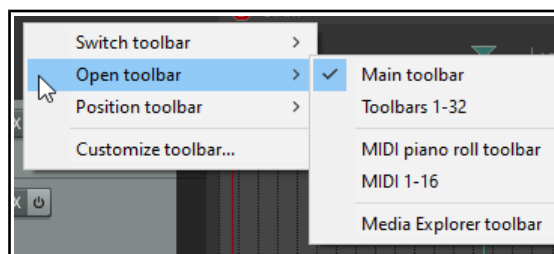

Each toolbar window can be dragged, resized and repositioned. It can be kept on top (using the pin symbol). Right click over the empty area of any custom toolbar to again display the menu shown (below). Options are:

Switch toolbar: selects and displays a different toolbar.

Open toolbar: use this to open another toolbar.

Position toolbar: used to dock a toolbar at the main toolbar, at the top of the main window, in the **toolbar docker**, or to float.

Customize toolbars: use this to open the **Customize menus/toolbars** window to enable you to customize the contents of any of the toolbars. By default, the currently displayed toolbar will be selected for editing.

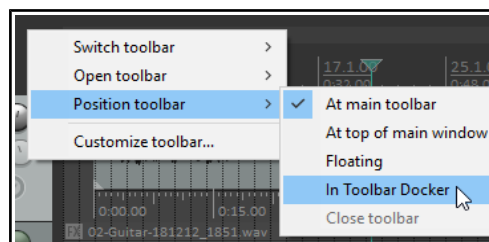

You can add commands to each or any of these toolbars as you wish. To select a different toolbar for editing after opening the **Customize menus/toolbars** window, display the drop down list from the top left corner of the Customize menus/toolbars window. The following table summarizes the main editing options.

In order to do this you need to do this.
Change the name of any tabbed toolbar	Select toolbar in the Customize Menus/Toolbars window, click on Retitle... then type the new name then click on OK .
Add an action or command to a custom toolbar	Click on Add... to display the Actions List. Select the command or action and click on Select .
To edit a custom toolbar button label	Right click over the item in the customized toolbar panel (left) and choose Text Icon... Type the text then click OK .
To assign an icon instead of text to a custom toolbar button	Right click over the item in the customized toolbar panel (left) and choose Change Icon... Select the required icon from those displayed, then close the Select Toolbar Icon window.
To remove an item from a custom toolbar	Select the item in the Customized Toolbar (left) panel and click on Remove .
To change the order of icons on a custom toolbar	Drag and drop items up or down the list displayed in the customized toolbar (left) panel.
To save a custom toolbar set	Click on the OK button in the Customize Menus/Toolbars window.
To export a custom toolbar set	Use the Export... button and choose Export current menu/toolbar to ... Type a name and click on Save .
To import a toolbar set	Use the Import... button, select the file name, click on Open .
To dock/undock the floating toolbar	Right click on floating toolbar, choose Dock floating toolbar then select one of the three options.

Example

1. With the **Customize menus/toolbars** window open select **Floating toolbar 1**.
2. Click on **Retitle...** and type **Screen Sets**. Press **Enter**.



Customization: Actions, Mouse Modifiers, Menus and More

3. Use the **Add...** button to open the Actions List window. Select **Screenset: Load window set #04**, then click on **Select**.
4. With the Actions List window still open, select the action **Screenset: Load window set #03** and again click on **Select**.
5. Repeat step 4 several times to select the other actions required for this toolbar..
6. Select the action **Screenset: Load track view #01** then click on **Select/close**.
7. If necessary, drag and drop any of these items up or down the list to put them in your preferred order.
8. If necessary, remove any unwanted items on this toolbar.
9. Right-click over each item in turn and choose the **Text icon** command. Enter a label, such as **Track Set 1** and enable the option **Double width toolbar button**.
10. Click on **OK** to save and close the **Customize menus/toolbars window** when finished.

Use custom toolbars for those activities that you use the most. For example, if you spend a lot of time editing media items, make an item edit toolbar.

15.25 Displaying a Toolbar as a Menu

REAPER's actions list includes actions to display any toolbar as a menu. Look for the actions **Show toolbar x as menu** and **Show MIDI toolbar x as menu**. Any of your custom toolbars can be displayed in this way.

Suppose that you have created a simple custom toolbar for managing project files. Let us say this is Custom toolbar 1. To enable this to be displayed as a menu:

1. Open the action list. Find and select the action **Show toolbar 1 as menu**.
2. Click **Add** and define a keyboard shortcut, such as **Ctrl Shift 1**. Close the action list.
3. Position your mouse where you wish and press **Ctrl Shift 1** to display the toolbar commands as a menu at the current mouse position.

15.26 Smart Tools and Armed Actions

If you have used other DAW software (such as Cubase, Pro Tools or Sonar) before coming to REAPER, then you might be used to using a toolbar for various editing tasks, such as splitting, deleting or muting items. You have already seen that this method of working is not native to REAPER. However, if you wish, you can create your own smart tools whose actions can be armed and used in a way similar to that with which you are familiar.

The Actions List includes numerous of actions suitable for this sort of treatment. This example will use the action. **Item: Split item under mouse cursor**. Other suitable actions include **toggle item mute**, **item properties toggle solo**, or to **delete items**.

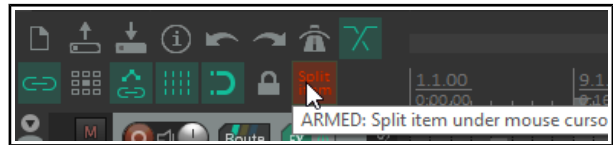

Without armed actions, any tool which makes reference to the mouse cursor, for example, would otherwise be useless – because the mouse cursor will be over the toolbar, not any media item, when the tool is clicked! By using smart tools we solve this problem.

To create a Smart Tool for any action or custom action, you first need to assign the action or custom to the toolbar, as explained in the section before this one. In this example, we have created a button to **Split Item Under Mouse Cursor**. Then, to use it as a smart tool, simply do this:

1. Right click over the tool. If you hover the mouse there long enough, a tool tip will be displayed. Move the mouse over any media item and it will change to a letter **A** (indicating that the toolbar action is armed).
2. Left click on (in this example) the item to which you want the action applied, at the exact position that you want the action to occur. In this case, the item beneath the mouse cursor will be split.



Once a tool is armed it will remain armed until you "unarm" it. For example, as long as a smart tool to toggle item mute is armed then every time you click on an item the mute status of that item will be toggled on/off. To unarm it, either right click on the armed tool. or press **Esc** immediately after using it.

Tip: A floating toolbar can be sized (made larger or smaller) by dragging its lower right hand corner in or out – look for the small dotted triangular area. If you want to restrict just how large the icons may become when you do this, enable the option *Don't scale toolbar buttons above 1:1* on the Appearance page of your preferences window. There is also an option *Don't scale toolbar buttons below 1:1*.

15.27 The Toolbar Docker

If you have several custom toolbars, the toolbar docker can be a useful means of accessing your various toolbars easily without creating a lot of screen clutter. It uses a tabbed layout that makes it easy to switch between your various toolbars whilst only displaying the contents of one toolbar at a time. In addition to this, the toolbar docker can itself be docked in any of REAPER's main dockers.

Shown below is an example where a user has created eight custom toolbars and made them all accessible from the toolbar docker:

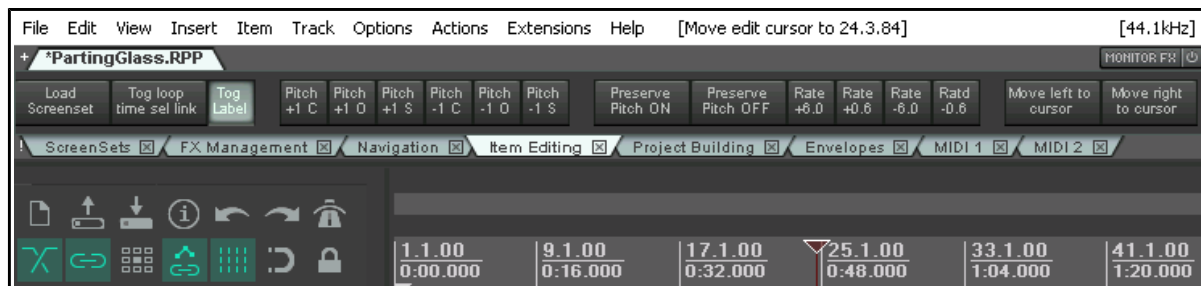

Display of the toolbar docker is toggled using the **View, Toolbar docker** command. A tip worth remembering is that toolbar layouts (tool positions) are by default saved with windows screensets. This makes it easier to switch between using and not using the toolbar docker, or using different toolbar selections in the toolbar docker at different times.

The following table summarizes the main features of the toolbar docker.

In order to do this you need to do this.
Add an open toolbar to the toolbar docker	Right click over the toolbar background area, choose Position toolbar, In toolbar docker .
Remove a toolbar from the toolbar docker	In the toolbar docker, right click over the toolbar's name tab, choose Position toolbar then Close toolbar or one of the display options such as floating or at top of main window.
Replace one toolbar on the docker with another	In the toolbar docker, right click over the toolbar's name tab, choose Switch toolbar then select the required toolbar.
Display toolbar contents	In the toolbar docker, click on toolbar name tab.
Dock the toolbar docker	Click on the ! (exclamation mark) on the left end of the toolbar docker, then choose any one of the four attach docker position options bottom, top, left or right. In the example shown above, this has been docked at the top.
Undock the toolbar docker	Click on the ! (exclamation mark) on the left end of the docked toolbar docker, then deselect the option Attach Toolbar Docker to main window .

15.28 Toolbar Appearance Preferences

You have already seen that you can customize toolbar appearance in a number of ways, including by importing your own icons. REAPER's **Appearance Preferences** include a number of options which can be used in conjunction with these options. These are to prevent toolbar scaling above and/or below a ratio of 1:1 (the default size), and whether to use frameless floating toolbar windows.

Customization: Actions, Mouse Modifiers, Menus and More

15.29 Using a Control Device with REAPER

A control surface can be used to control some of REAPER's actions. You might also be able to use your pedals and other controls on a MIDI keyboard in a similar way. Examples might include track panning and volume, mute and solo status, arming and starting/stopping recording, and possibly to physically map REAPER's transport bar for functions such as Play, Stop, Pause, Rewind, etc. You will need to know the characteristics of your particular device, including how to install it, set it up and so on. That is obviously outside the scope of this User Guide.

Different control devices have different capabilities. Not all control surfaces can be used to control all actions, even those that are listed as midi CC capable. Obviously it is also beyond the scope of this user guide to present a detailed analysis and comparison of all these. In overview, however, they fall into two broad categories:

- Devices which can be recognised by REAPER as a specific and individually named control surface.
- Generic devices not specifically recognised but which can nonetheless be used as a control surface.

If you have a control device of a type listed in the illustration here, first make yourself familiar with its documentation. Next, install the device and its drivers on to your computer in accordance with the manufacturer's instructions. You should then be able to select it on the **Control/OSC/Web** page of REAPER's Options Preferences settings. Of course, you should consult the manufacturer's documentation and/or web site for further information. You may also be able to find further information on one of REAPER's on-line forums.

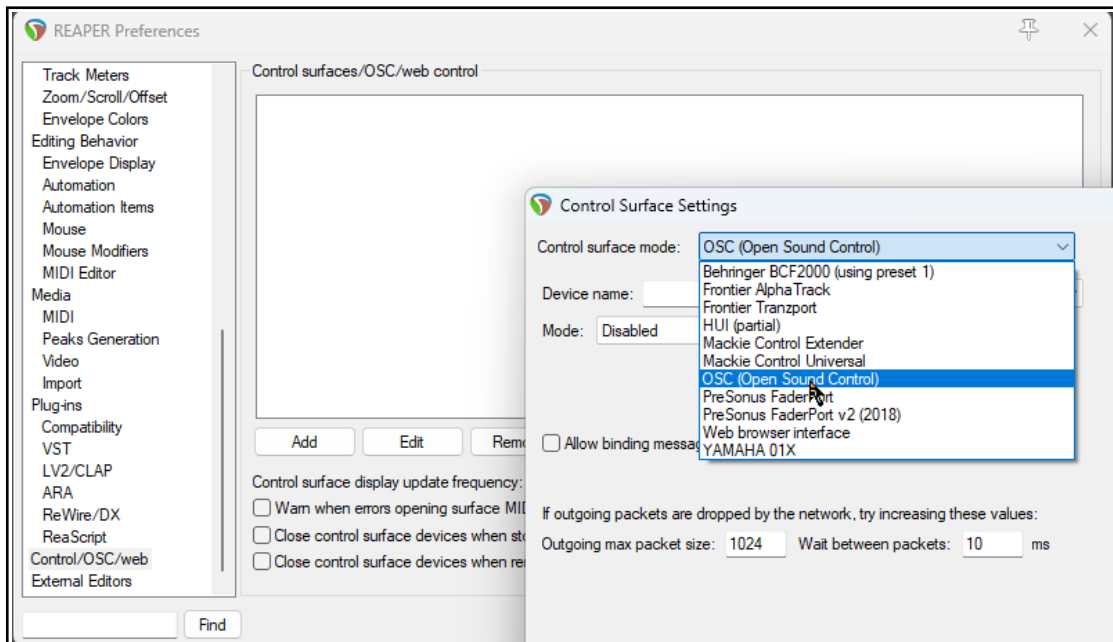

Choose the **Options. Preferences** command, then select **Control/OSC/Web** and click on **Add** to see a list of available devices (see above). The list includes an entry for devices which conform to the **OSC (Open Sound Control)** protocol. Familiarise yourself with its documentation and characteristics before proceeding.

If you choose this option from the list, the screen that then follows will give you the opportunity to specify a device name and pattern configuration. This includes choices such as LogicTouch or LogicPad, or to tell REAPER to write a sample (default) configuration file. This file will contain the default mappings and various appropriate comments. You should also supply a port number (for the transfer of messages) and IP addresses for both the host and the device itself. Go to <http://www.cockos.com/reaper/sdk/osc/osc.php> to learn more about how REAPER handles OSC and about REAPER's Default.ReaperOSC file.

For non OSC control devices not shown on this list, you might be able to install them if they are capable of emulating one of the devices that is listed (e.g. HUI or Mackie emulation).

REAPER preferences include options to **Warn when errors opening surface MIDI devices**, **Close control devices when stopped and not active application** and **Close control surface devices when rendering**.

Up and Running: A REAPER User Guide v 7.31

In every case, make sure that you choose the options that are correct for your device from the various **Control Surface Settings** options. Shown below is one example of such settings, with a Novation Nocturn. This sample screen is not intended as a model for you to use with any particular product.

You might wish to install several devices in this way. For example, you might wish to use both a Frontier AlphaTrack and a Frontier Tranzport. This is perfectly possible, so long as each device is installed correctly.

You will need to consult the product documentation to ascertain how then your control surface(s) can be used with REAPER.

If your device is not on the list of recognised control surfaces and cannot emulate any of the items on that list, you can still use it with REAPER. An example of such a product is the Behringer BCR2000. Once it has been physically set up and installed on your computer, it will appear on the list of REAPER's MIDI Devices. Depending on the actual product and which drivers you are using, it might appear on this list with its own name or merely as a **USB Audio Device**.

Install it as a MIDI Device, most likely Input Only and in most cases for control messages only. An example of this is shown here. You can double-click on the device name to open the **Configure MIDI Input** dialog box. What you do next will depend on the device. You might also use this method to use your MIDI keyboard also as a MIDI controller (depending on whether the keyboard supports this feature).

Once such a device is installed, you can then assign any action listed as supporting midi CC control to one of the knobs, faders, buttons or rotaries on your control device.

The procedure is similar to assigning an action to a key on your PC keyboard. Open the **Actions** List from the REAPER menu. Select the action, click on **Add** then instead of pressing a key on the keyboard, tweak the control surface control and click on **OK**.

An example is shown on the right - in this case we are assigning a rotary control to be used to adjust the volume of track 1.

For further information, including about the various settings, you should consult

the documentation supplied with your device, the manufacturer's web site, or one of the REAPER forums.

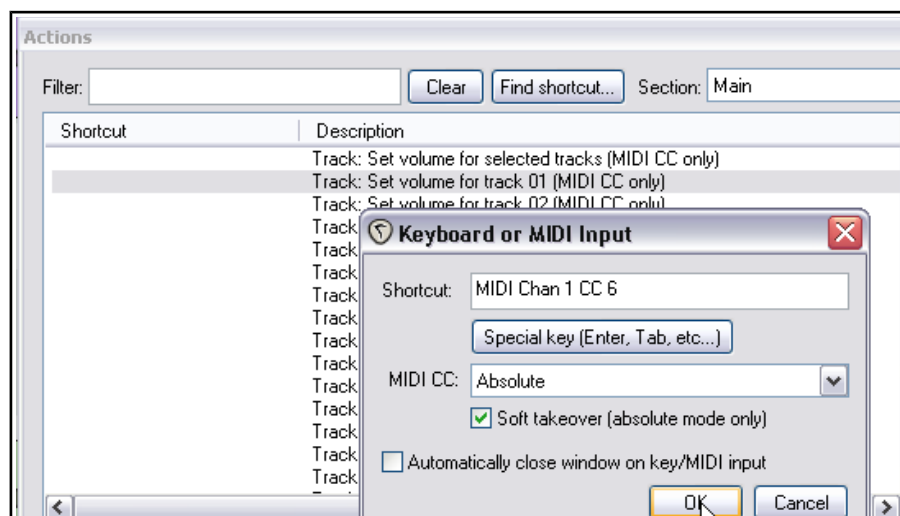
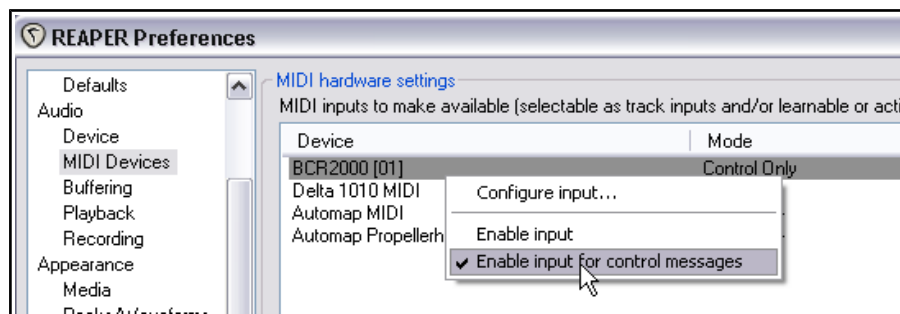
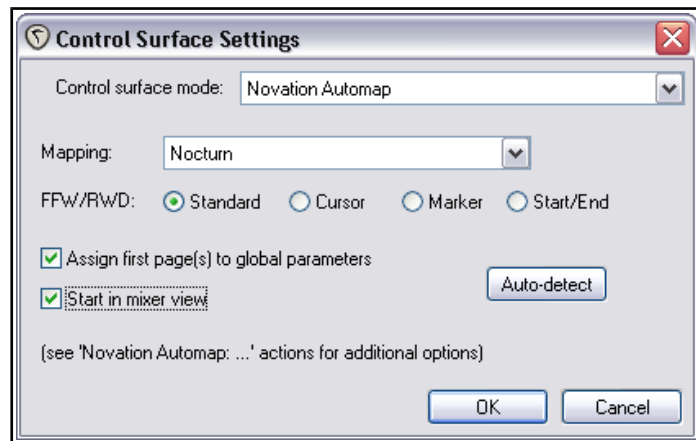

Customization: Actions, Mouse Modifiers, Menus and More

15.30 Controlling REAPER with a Web Browser Interface

You can use your mobile phone or tablet as a control surface for REAPER, for example to record tracks, play them back, solo or mute tracks, and so on, using REAPER's web browser interface!

Make sure that your REAPER computer is on-line. Open any project, or start a new one. Open the **Control/OSC/web** page of your **Preferences**. Click on **Add** and from the **Control surface mode** dropdown select **Web browser interface**, to open the dialog shown here.

This example shows **basic.html** selected from the **Default interface** dropdown: this is a simple interface provided with REAPER. If you prefer a graphical interface, try **index.html**. Other options might be available on the drop-down, or in **Built-in pages**. The interface that you select will determine, amongst other things, the look and layout of the interface and exactly which REAPER tasks you will (and will not) be able to perform in your web browser. You can store any interfaces that you create or download yourself in the **User pages** folder.

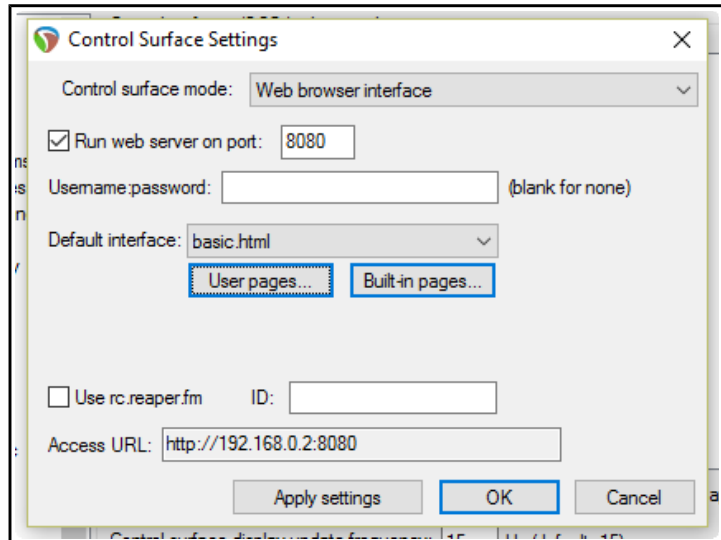

Click on **Apply Settings**. Make a note of the *exact* **Access URL** shown on your screen.

Open any browser (e.g. Chrome or Safari) on your phone or tablet and enter the exact access URL code in its search bar. You will be taken to a screen similar to that shown below (but see footnote below).

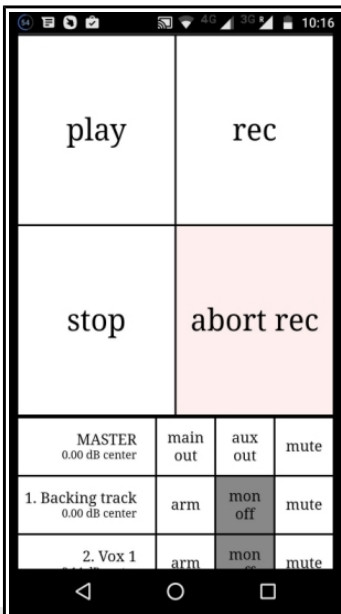

The four main buttons are play, stop, record and abort record. Below these, your tracks are listed, starting with the master track. Individual tracks can be armed, monitored or muted.

Touch any track to see it displayed as shown here on the right. There is a vertical volume fader on the left and various other track controls as shown (mute, solo, etc.) Click on the **X** to return to the main view.

The HTML interface file includes HTML, CCS and Javascript. It defines what you see on your phone and how it behaves.

In the finest REAPER tradition, users can develop their own scripts for a customised web mobile interface, or to make one available to other users. Check out on the [REAPER Stash](#) from time to time! You never know what you might find there!

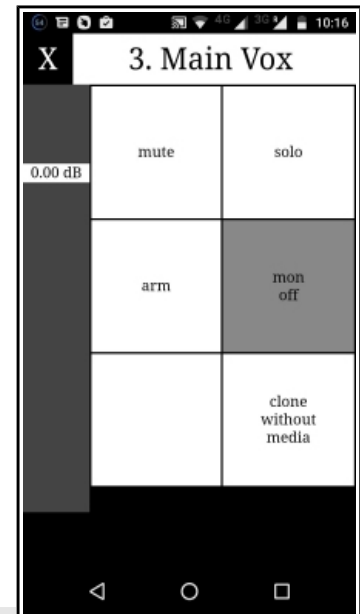

Footnotes: With some Windows

installations, in order to get this to work you might need to manually adjust some settings. In this example, 8080 is the port number. On most Windows systems, this is pre-defined as open, but you might wish to use a higher number, e.g. over 9000. If so, you will need access your Windows Firewall settings to open the port that is being used, and to give REAPER inbound and outbound access.

If you prefer, you can tick the **Use rc.reaper.fm** box. This will record your local IP and create a permanent URL link which will always redirect to your local IP even if the local IP changes. Just follow the on-screen instructions.

15.31 Customizing Track Panel Area Width

There are any number of situations in which you might wish to change the width of the track panel area in arrange view. For example, you might wish to make more space available for your actual arrangements.



If you hover your mouse over the border between the track panel and the main (arrange) area then a vertical colored line with a double-headed arrow will appear (as shown here).

This line defines the boundary between the track panel and the arrange area.

This boundary line can be moved to adjust the width of the track panel relative to the main area. Drag left and the panel will become narrower: drag right and it will become wider.

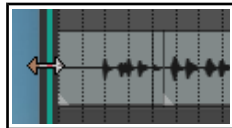

The first time that you double-click on that boundary line the TCP will be removed from view altogether (as shown here). If you then move your mouse to just inside the left edge of your REAPER window and hover there then the boundary line will again be displayed.

Double-click on this and the TCP will be restored to its previous position. Thus, double-clicking on the boundary line will toggle you between the two states.

This trick can be handy, for example, if you wish to temporarily give the whole screen to the arrange area to work there, knowing that the TCP can be restored at any time with a simple double-click. To summarize:

- ◆ Double-clicking on the vertical boundary line between the TCP and arrange area will toggle you between two states, i.e. the previous state will be restored, so that that now becomes the current state.
- ◆ Dragging that line right or left will increase or decrease the TCP width for the current state.

Finally ... when you close REAPER, it will remember your current boundary position and restore that when the program is next reopened.

15.32 Reset VU Meter Peaks

During playback, your VU meters in both track view and mixer view will display the peak level recorded for each individual track. To reset the peak reading for any individual track, click your mouse over the area where the peak value is displayed. To reset the peak reading for all tracks, hold the **Ctrl** key while you click your mouse over the area where the peak value is displayed in any one track.

You can disable the option under [Track Meter Settings](#) **Reset meter peak indicators on play/seek**. If you do this, the current peak levels will be remembered even when you stop playback.

15.33 The Theme Adjuster (Overview)

The REAPER 7 Theme Adjuster (**Options, Themes, Theme adjuster/Color controls**) works with the default REAPER 7 theme (**Options, Themes, Default**) in enabling you to customize various aspects of REAPER's appearance, in particular the track, envelope, mixer and transport panels.

The track and mixer panels are of special interest. For example, you can change the order in which the various controls are laid out. You can also define alternative layouts for each of these, including different layouts to be used in different scenarios – such as whether the track is selected, or not selected, or armed.

The script developer strongly advises that the best way to learn and master the theme adjuster is by exploring and experimenting for yourself. With this in mind, be aware that:

- ◆ Changes that you make to settings are saved automatically. In most cases your actions are not recorded in the undo history.
- ◆ Double-clicking on controls will generally restore them to their default setting, and, most importantly....
- ◆ The theme adjuster is a self-contained script. Your changes to any of these panels will affect only the on screen appearance of the track, envelope, mixer and transport panels. Nothing you can do here can damage REAPER in any way.
- ◆ If you get into strife, there is an option to **Reset all values to their default**.

16 REAPER Plug-ins in Action

16.1 What Are Plug-ins?

There's a wonderful assortment of plug-ins supplied with REAPER - over 200 of them! These include the Jesusonic and the VST Rea plug-ins from Cockos. This section will introduce you to some of these, to give you a feel for what plug-ins are and how they work. Beyond this, you can explore for yourself.

Plug-ins are software that are used mostly to control and shape the sound generated when you play back the media items in your tracks. Some simple examples of when and why you might want to use a plug-in are:

- To make a vocal recording sound better, more lifelike. Plug-ins can add body, warmth and sparkle to such a track, not by working magic, but by bringing out qualities that might be buried in the recording.
- To smooth off peaks and dips in the volume of a track, making the overall track sound more even.
- To add a "live" feel to a track or even a whole mix, making it sound more as if it were recorded in a church or a concert hall, rather than in a boring old studio.

When working with plug-ins, keep these three guiding principles in mind:

1. It is better not to use a plug-in at all than to use it badly. A badly used or overused plug-in is likely to make your mix sound worse, not better. If in doubt, underdo the use of plug-ins, don't overdo them.
2. Never judge the quality of a plug-in by how much you like its presets. Presets reflect someone else's idea of how something ought to sound, not the quality of the plug-in, nor its potential. To get the best out of any plug-ins, be they EQ, compression, reverb or anything else, you will need to take the trouble to understand their various parameters. That takes time.
3. You can't judge the quality of a plug-in by its cost. Some free ones are pretty awful, some are great. Some plug-ins costing hundreds of dollars are quite ordinary. Others are excellent.

16.2 Five Types of Plug-in

Especially when you are new to digital audio, when you start to explore the world of plug-ins you might find yourself feeling overwhelmed, if not utterly confused. Why? Because there is so much choice. *Heaven help me, have I really got to understand all that lot to be able to use this recording caper?*

No, you don't. Learn in steps as you go. Broadly speaking, many plug-ins can be thought of as belonging in one of five categories of plug-in (although there are exceptions). These five types are:

- **Sound Shaping:** these plug-ins affect the frequency (pitch) of your track(s). An example is EQ.
- **Time-Based Effects:** these plug-ins manipulate how your track(s) interact with time. Examples include Delay, Chorus and Reverb.
- **Analytical Plug-ins:** these display information, but don't in any way alter the sound of the track.
- **Volume Changing:** these are plug-ins that determine the overall volume or perceived volume of your track(s). Examples are Compressors and Limiters.
- **Routing Plug-ins:** these do not shape the sound of your tracks as such, but are used for tasks such as routing. Routing is generally beyond the scope of this chapter: [we'll get to it in Chapter 17](#).

And those exceptions? Well, some plug-ins cut across more than one of these categories, performing more than one job. An example is a Multiband Compressor, which in some ways acts as both an EQ and a Compressor.

It would be way beyond the scope of this User Guide to teach you the science between these various plug-ins – that would require an entire volume in itself! Our objective is to give you an introduction to what REAPER offers in this area, and to show you how REAPER's own interface is used to control them.

16.3 Adjusting Plug-in Parameter Controls

Cockos Rea Plug-in faders can be adjusted using any of four main methods. These are:

- Hover your mouse over the fader and scroll the mousewheel. Use **Ctrl** for finer adjustments.
- Click on a fader and drag the mouse. Hold the **Ctrl** key for finer adjustments. Hold **Alt** for "elastic" auditioning: the control will return to its original position when the mouse is released.
- Click on the fader then use the **Up** and **Down** arrow keys.
- Click in the parameter value window (in the first example show below, you can see one of these to the immediate right of each of the three horizontal faders) and type a value.

If you prefer not to use the first of these methods (for fear of making accidental adjustments), you can enable on the [Editing Behavior, Mouse](#) page of your Preferences the option **Ignore mousewheel on all faders**.

16.4 Sound Shaping Effects: ReaEQ

EQ means "equalisation." It is used to emphasise (or de-emphasise) selected frequencies.

ReaEQ is REAPER's main EQ plug-in: there are also several JS EQ plug-ins but ReaEQ is the most powerful and flexible. Let's take an example.

1. Open the project file **All Through The Night.RPP** and save it as **All Through The Night EQ.RPP**. Select track 1.
2. Click the **FX** button, click on **Cockos** then on **VST: ReaEQ**. By default this has 4 band tabs.
3. Play the song. Select **Band 4** and fade the **Gain** left to about -35 dB. The voice becomes deeper. Double click on the fader to return it to the centre.
4. Select **Band 2**. Fade the Gain down to about -14 dB. Notice how tinny and even disembodied the voice sounds. Double-click to return to normal. Now lift the Gain to about +3 dB. The voice should sound quite pleasantly fuller and warmer. Select Band 3 and set the Frequency to about 4200. Observe what happens as the gain is adjusted between +3.5 and -3.5. When finished, return it to 0.0. Save the file.

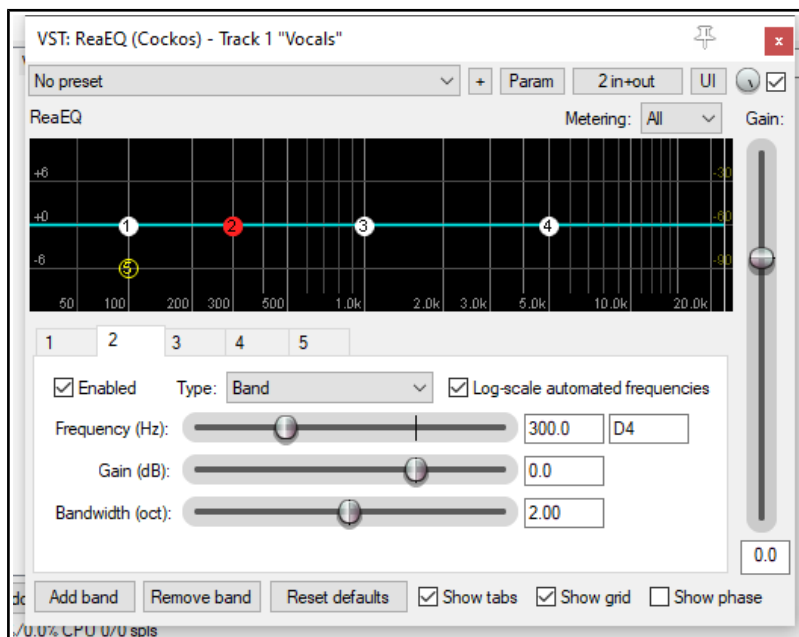

Frequencies are a huge subject and go way beyond the scope of this guide Here is a brief introduction. Exactly how you divide up the frequency spectrum is to some extent arbitrary. Here's one way that makes sense:

Frequencies	Comments
16 to 60 Hz	Very Low Bass. These frequencies are felt rather than heard.
60 to 250 Hz	Bass. Herein dwell the fundamental notes of the rhythm section. A modest boost here can help make a sound fuller, but too much gain will make it boomy.
250 to 2000 Hz	The Mid Range. Too much gain here makes it sound like you've recorded from the other end of a telephone. If a take sounds muddy, try cutting it here.
2000 to 4000 Hz	Upper Mid Range. Often a tricky area. Too much can cause listening fatigue. Lower this range a tad on the mix while boosting a tad on vocals can help a vocal stand out.
4000 to 6000 Hz	Presence Range. The key range for clarity and presence of instruments and vocals. Some gain here will bring the part forward in the mix. A drop can pull it back.
6000 to 16000 Hz	High Range. This is where you find clarity and sparkle. Too much gain here produces a searing, glassy effect. Not enough will sound dull and "heavy".

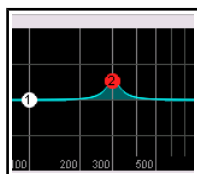

Now let's look at bandwidth. ReaEQ measures bandwidth in octaves. A narrow bandwidth setting means that you will raise or lower the sound over a very small part of the frequency spectrum. A wide setting means that you will be working on a much wider part of the spectrum.

Examples of how a narrow bandwidth (left) and a wider bandwidth (right) can shape a sound are shown here. You will also see, if you display the

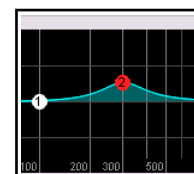

drop down list labelled **Type** that there are several type of band. Some commonly used are:

Band: the volume is raised or lowered either side of the frequency, the range being determined by the bandwidth setting. Sometimes called a "peaking filter."

REAPER Plug-ins in Action

Low/High Pass: filters out frequencies above/below the frequency setting.

Low/High Shelf: causes the gain to be moved below/above the frequency setting.

Pass and Shelf will in most cases only be used (if at all) at very low frequencies or very high frequencies.

Parallel Band Pass: these run independently of each other and are then summed.

You can add or remove bands using the **Add band** and **Remove band** buttons. To adjust parameters of any band you can use the fader controls (frequency, gain and bandwidth), enter values directly in the edit boxes, or drag the handles on the graph display itself.

As well as the usual mouse controls, you can use **Ctrl mousewheel** to fine-adjust bandwidth and **Ctrl Shift drag** when adjusting the point for fine adjustment of bandwidth. Right-click on any of the band handles on the graph for a **context menu** whose options include:

- Adding** or **deleting** a band
- Flipping** all bands
- Enable/Disable** band (toggle)
- Changing** the band type
- Using **large band handles**
- Reset** current or all bands to 0 dB
- Setting analyzer slope** (0 dB, 3 dB or 5 dB per octave)

Other toggle options to **log-scale automated frequencies**, **show tabs**, **show grid** and **show phase display**. Note also the **Gain** fader (on the right), used to adjust output volume.

Wet/dry mix rotary control (near the top right corner of the FX window): this creates a mix of the wet and dry signals. Full left is 100% dry, full right (the default) is 100% wet. **Alt click** to toggle on/off the option **Delta solo** – the difference between dry and wet signals. This option is on all FX windows. See also [Chapter 17](#).

EQ channel settings and channel analysis:

By default, your ReaEq settings will be applied to all track channels. For example, for a stereo item, the settings will be applied to each channel. If you wish to change this (e.g. to EQ only the left channel of a stereo pair) you can do this with REAPER's [pin connectors](#). These are explained in detail in the [chapter that follows this one](#).

That said, even while applying the FX (for example) to both channels in a stereo pair you might wish to view the effect of that FX on just one of those channels. This can be achieved by selecting the required channel(s) from the **Metering** dropdown. For a normal stereo item, your options will be All, 1, 2 or none.

Tip: Don't forget that you can create track parameter controls and/or automation envelopes for this or any other plug-in by clicking on the **Param** button in the plug-in window – [as explained in Chapter 11](#).

16.5 Time Based Effects: Delay

These include reverb, delay and chorus. Sound takes time to travel: surfaces like walls and ceilings create reflections which make the sound patterns more complex. Time based FX use various techniques to artificially simulate this, thereby creating a more "live" sound. But go easy!

About a dozen JS delay plugins are available, ranging for simple delay to floaty delay, or delay with chorus, sustain, stereo bounce, and more. Chorus options include mono, stereo and ozzifier. Shown here is the JS Delay.

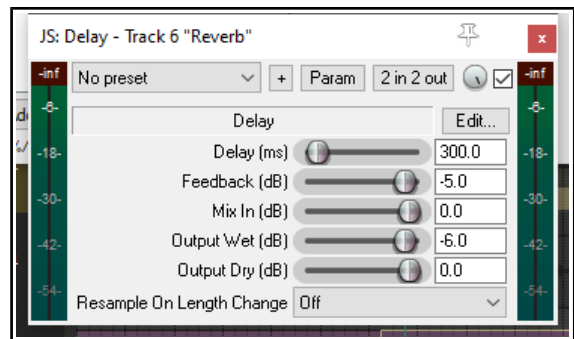

Parameter	Description
Delay (ms)	Sets the amount of time to pass between the dry sound and the delayed sound.
Feedback	Determines the amount of the delayed signal that will be fed back into the delay itself. This helps to prevent the delay from just being an echo.
Mix in (dB)	Determines the overall output level.
Output wet (dB)	Determines the Output level of the Post FX signal. Lowering this relative to the dry output will make the effect more subtle.
Output dry (dB)	Determines the Output level of the Pre FX signal

Note: The plug-in **ReaDelay** is a powerful alternative to JS Delay. For example, it allows the use of multiple taps to use different combinations of settings together. This (along with the other Rea effects) is described in the free **ReaEffects Guide** - <https://dlz.reaper.fm/userguide/REAPEREffectsGuide2021.pdf>

16.6 Analytical Plug-ins: the Frequency Spectrum Analyzer Meter

Shown on the right is a **JS: Frequency Spectrum Analyzer Meter** (Cockos) - Master Track plug-in.

Insert this into any track's FX chain (or the master's FX chain) and as the project is played you are given visual feedback as to the level of output at different frequencies.

This plug-in is explained in detail in the free [REAPER Cockos Effects Summary Guide](#).

Three Cockos plug-ins – ReaEQ, ReaFir and ReaXComp - include an analytical display similar to that shown here as part of their standard interface.

Now that you've had a look at some examples of different types of plug-in, we can go on and examine some more.

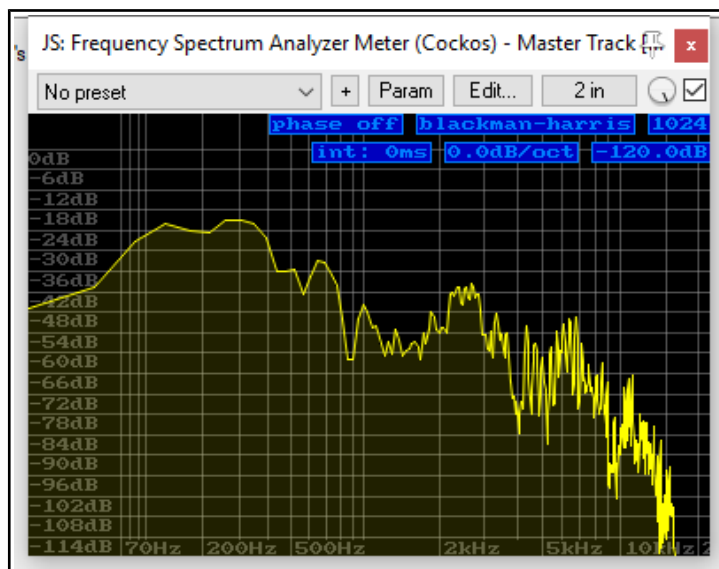

16.7 The JS Master Limiter and ReaLimit

Several plug-ins are available which are designed to limit the maximum volume either on any track or on the master (e.g. MGA JS Limiter, Simple peak limiter, Soft clipper).

The **JS: Master Limiter** can be added to the FX Window for your Master to perform two functions. These may at first appear to be contradictory, but they are not:

- To raise the overall volume of the mix, but also ...
- To prevent the mix from "clipping", i.e. getting too loud at any point.

This example uses the **JS: Master Limiter** which includes the following controls and parameters:

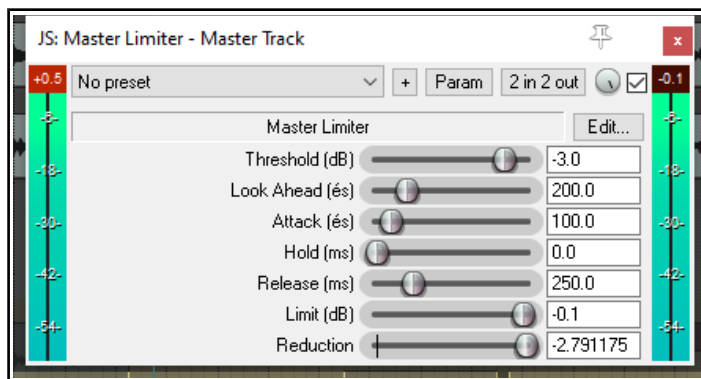

Parameter	Description
Threshold	Determines the level at which the other limiter settings will be applied. It may seem paradoxical, but the lower the threshold, the higher will be the perceived overall volume. As you lower the threshold, more of the song is lifted to the limit specified.
Look Ahead	Determines how far ahead the limiter looks – this helps smooth out sudden peaks.
Attack	Determines how quickly the limiter kicks in as the signal increases.
Release	Determines how quickly the limiter recovers after a peak is encountered.
Limit	This determines the maximum volume that cannot be exceeded.

Another available limiter is **ReaLimit**, which is a brickwall limiter.

Regular limiters drastically reduce the dynamic range: brickwall limiters take it a step further. A regular limiter will mostly keep the volume at or below the threshold, but some sound may still pass the threshold, especially if you're pushing the gain on the track. When using a brickwall limiter, nothing will ever be louder than the threshold.

More information about [ReaLimit](#) can be found in the chapter dealing with the mixer and the master.

REAPER Plug-ins in Action

16.8 Using FX Presets

When you are satisfied with your settings for any plug-in, you might wish to save them as a preset, so that you can apply them next time you want to use it on another track:

1. Click on the **+** button just above the JS Delay plug-in when this plug-in is selected.
2. Choose **Save preset** from the menu.
3. Type a name and click on **OK**.

To save these as default parameter settings for the plug-in when it is used in the future, use the **Save preset as default...** command from the same menu.

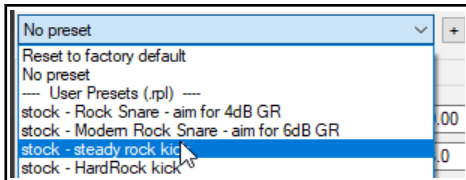
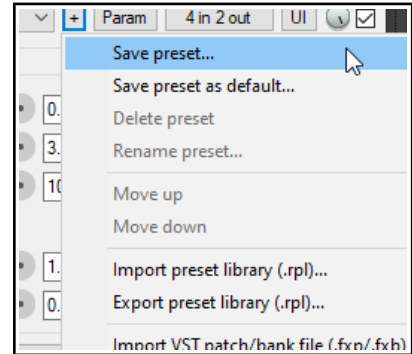

To import an existing preset library (such as you might be able to download from the REAPER web site) you would choose **Import preset library**. To export your presets to a file (for backup purposes, or to use on another computer) you would choose **Export preset library**.

To choose an existing preset (previously saved or imported, or which were supplied with the plug-in), insert the plug-in into that track's FX window, display the drop down list of presets (see above), then select the one that you want.

Within the FX Browser, you can select a preset when adding an FX to the FX chain. Right-click over the plug-in name then from the context-sensitive menu choose

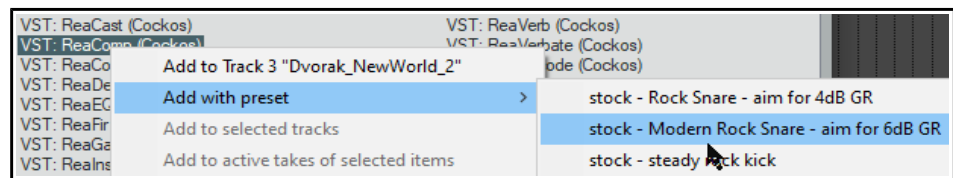

Presets, then select the required preset from the displayed list.

16.9 Volume Control with Compression: ReaComp

Earlier in this chapter, we encountered a **limiter**. You can think of a limiter as being like imposing a ceiling – it stops the volume of a signal from going above whatever level you set.

Because limiting can be harsh, it is often better to use a compressor on individual tracks. Think of it this way – a simple limiter cuts in suddenly and severely, whereas a compressor can be eased in much more gently. It might help to get a visual picture of what limiting can do to a recording compared to a well applied compressor. The three illustrations show the same waveform first as recorded, then how it might look with limiting (center), and with compression instead of limiting (right).

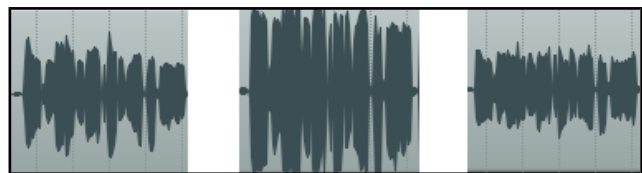

Notice that on the original waveform the volume varies considerably from time to time. Applying a limiter can lift the quieter passages, but may make the overall effect too loud. The dynamics might be largely squeezed out of the song. The illustration far right shows the same waveform after carefully using a compressor instead of a limiter. The track no longer clips, and more of the dynamics of the recording have been preserved.

Software compressors vary from the simple to the complex. We're going to concentrate here on just six essential controls. There are other factors, but let's just focus on these six for now.

- **Threshold** - This is the volume at which the compressor will kick in. For example, if you set your threshold at, say, -10dB, then nothing below that threshold will be compressed.
- **Ratio** – This determines how gently or severely the compression is required. A relatively harsh ratio like 2 to 1 would ensure that for every 2 decibels the volume of the recording goes above the threshold, the sound will be increased by only 1 decibel. A more gentle ratio such as 12 to 1 would mean that for every 12 decibels the recording goes over the threshold, the sound will increase by only one decibel.

Up and Running: A REAPER User Guide v 7.31

- **Gain** – Adjusts the volume of the track after compression. Often you will want to raise the overall sound at least a little, to prevent the overall volume of the track from now being too quiet. The gain control in **ReaComp** (above) is labelled **Wet**.
- **Wet/dry** rotary (top right). Determines how much of the unprocessed signal is mixed with the processed signal. Fully right (as shown) this will be 100% wet: fully left will be 100% dry.
- **Bypass** – this is the small tick box in the top right corner, next to the wet/dry rotary. When this is ticked the plug-in is active. When unticked it is set to bypass.
- **Limit Output** (bottom right) – This option will prevent the compressor output from exceeding 0 dB.

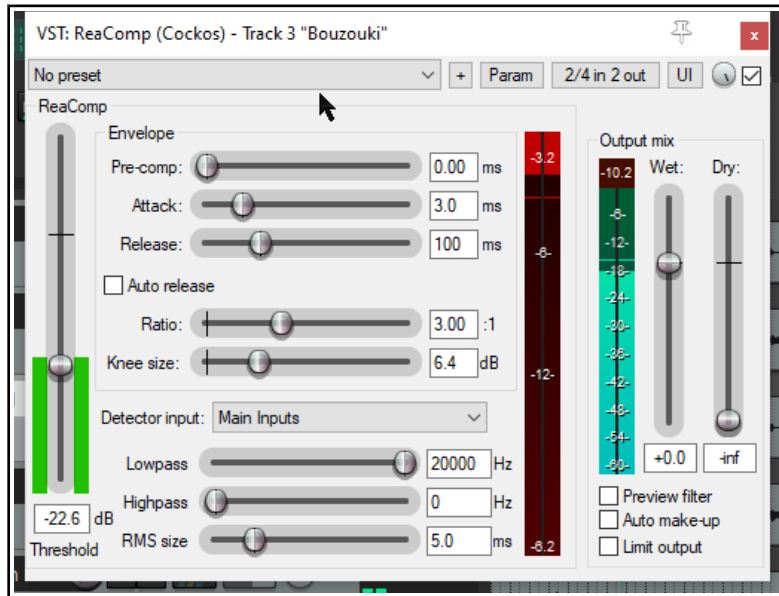

Note also the three controls **attack**, **release** and **knee size**. These help to control how the compression is shaped and applied. **Attack** determines how long the compression takes to reach its full effect. The **release** setting determines how quickly the compression will be removed when the signal falls below the threshold. **Knee** determines how sharply or gradually the compression is applied.

For other more advanced controls, see the free **ReaEffects Guide**:
<https://dlz.reaper.fm/userguide/REAPEREffectsGuide2021.pdf>

Example

1. Open the file **All Through The Night.RPP** and save it as **All Through The Night COMP.RPP**
2. **Solo** the **Bouzouki** track. Look at its media peaks. You can see that it starts at a steady volume, but over the last 30 seconds or so of the song it gets rather loud.
3. Play the track from the 55 second mark for about 15 secs then stop it. Try applying some compression to kick in at about -12 or -13 dB.
4. Display the FX Window for this track.
5. Insert the **VST: ReaComp (Cockos)**.
6. Create a loop to play over the last 20 secs or so of this instrument.
7. As you do so, experiment with setting the Threshold (vertical fader on the left) and the Ratio. Select the option to **Limit** Output. You'll probably end up with a setting of something like -16 on the Threshold and a ratio around 4:1 or 5:1 (see picture).
8. Now save this file.

Channel Modes (Advanced topic)

By default, ReaComp operates in **stereo** mode: this means that all active audio channels (usually 1 and 2) will be compressed based on analysis of the loudness of all such channels summed together. For many, if not most, users, this will be the only method you need. Indeed, this mode is mandatory if you are using a compressor with sidechaining (see [chapter 17](#)).

However, on the ReaComp I/O button right click menu there are also two mutually exclusive toggle options for **multi-mono** and **multi-stereo** modes. In multi-mono mode, each channel is compressed separately (with the same settings) based on an analysis of that channel. In multi-stereo mode, each individual pair of channels is compressed independently (with the same settings) based on an analysis of that stereo pair.

Channel modes are also discussed variously in [Chapter 17](#), in the contexts of channel routing.

REAPER Plug-ins in Action

16.10 Volume Control with a Noise Gate

Noise gates control sound at the quiet end of the scale. When you record a track there might be sections of silence, perhaps between verses. However, you might notice on playback irritating sounds have been recorded at a low level during these periods. A noise gate can detect these and filter them out. Like the compressor, the gate can be quite simple or more sophisticated. Here we are going to focus on the basic noise gate controls:

- **Threshold** – Used to specify a minimum sound level below which the noise gate will kick in.
- **Attack** – Specifies how quickly the gate kicks in. Too soon can cause the natural decay to be cut off.
- **Hold** – Specifies how long the gate remains open after the signal falls below the Threshold.
- **Release** – Determines how soon the gate closes after the signal has fallen below the threshold.
- **Hysteresis** – The degree of tolerance allowed before opening or closing the gate (rather like a thermostat!).

This example, uses the project **All Through The Night COMP.RPP**

Example

1. Solo the Vox track.
2. Play the song from just before the end of the first verse. If you listen carefully (especially thru headphones) you can hear some unwanted sounds during the otherwise silent passage. Certainly you can see this on the track's VU meter.
3. Open the FX Window for this track and add **Cockos VST ReaGate**.
4. Play the song again. Adjust the **Threshold** fader (the first on the left) to a level just above that at which the Threshold's VU meter is peaking during the quiet passages (see below). This will shut out the sound – visual confirmation is given by the VU meter on the right, which should now display no activity.
5. You will probably find that the default settings for Attack, Hold and Release work quite well, but experiment with adjusting them if you wish. Save this file again.

You have just seen here a simple example of using a noise gate. Noise gates can be used to great effect and for a large number of applications (including with a drum kit to cut out the bleed between mics). Applications like that are more complicated and require a greater understanding of the noise gate's many parameters.

Channel Modes. Like ReaComp, ReaGate supports different-channel modes (see previous page). These can be toggled on/off from the I/O button right-click menu. Multi-mono mode will cause the settings to be applied independently to each channel: multi-stereo mode applies these settings independently to each stereo pair.

16.11 Time Based Effects: ReaVerb

ReaVerb is a VST plug-in that is supplied with REAPER. Reverb itself is a time-based effect, and ReaVerb uses a type of reverb known as **convolution reverb** to create the illusion of space. This section will introduce you to the basics of using ReaVerb. After that, it has more features that you can explore for yourself.

Most reverbs attempt to simulate the effect that the acoustic environment of, say, a hall or a room would have on sound. However, the mathematics required is complex, so that few come close to sounding like real acoustic rooms. Reverb plug-ins vary not only in their essential quality but also in the scope of their applications.

Convolution reverb can give you realistic reverb on a budget. It uses impulse responses of real acoustic spaces. This is done by first generating a signal in the required environment and then recording the result.

ReaVerb allows you to both use recorded impulses from real environments to create your reverb, together with something closer to traditional reverb techniques to modify that sound further.

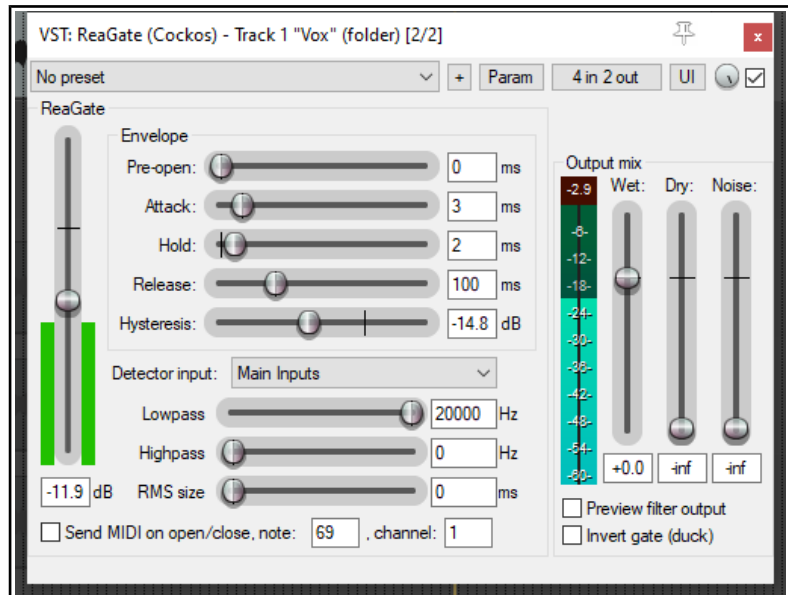

Up and Running: A REAPER User Guide v 7.31

To use convolution reverb you will need impulse wave files. Search the net to find all you want, many free. This example uses files downloaded from <http://www.voxengo.com/impulses/>. In the example that follows, these files have been downloaded and stored in a folder that we have created and named **C:\Program Files\REAPER\Reverb Impulses\Voxengo**

Example

1. Open the file **All Through The Night.RPP** and save it as **All Through The Night REVERB.RPP**
2. Add a new track after the last track, and name it **Reverb FX**
3. Add receives into this track from each of the instrument tracks and the Vox track. This will later enable you to feed different levels of signal, panned as required, from different tracks into your Reverb Bus.
4. Display the **FX Window** for the track **Reverb FX** and add **ReaVerb** into this FX Window.
5. Fade the **Wet** level down to around **-60** and the **Dry** level down to about **-0.5**, as shown above. We will start by adding just a little reverb, then increase it as required.
6. Click the **Add** button and then on **File** to add a file at the start of your Reverb chain. Navigate the file browser window to where your impulse files are stored and select one. In this example, we will be using **St Nicolaes Church.wav**
7. Click on **Open** to insert that file into ReaVerb., which now shows a spectral display of this file (see below). Files can also be inserted by drag and drop from media explorer.
8. **Play** the file. In the track window, lower the volume for the reverb bus to about **-10dB**. Lower the master volume to about **-6dB**. You can adjust this as if you wish.
9. In the ReaVerb window, raise the wet signal until you hear a pleasing amount of reverb. This will probably be at about **-10 dB**. If you like, Solo the Reverb track for a while, so that you can discern the effect more clearly.
10. We can now use the ReaVerb controls to adjust the Reverb effect. The **Pre-reverb** fader offsets the reverb tail by delaying the signal that is sent to the reverb tail generator. Try it for yourself.
11. To add more controls to the Reverb chain, click on **Add** and choose **Time/Gain/Stretch**. Your window suddenly has all these extra controls. These are used to stretch the impulse (make it longer), add in some graininess, or trim the impulse (make it shorter). The best way to find out is to experiment!
12. Again click on **Add** and add a **Filter (LP/HP)**. This causes a high pass and a low pass filter to be added. This can be used to stop the reverb impulse from being applied to very low and/or very high frequencies.
13. When satisfied, you can save that set of parameters as a named preset that can be recalled for other projects. Click on the **+** button, choose **Save preset**, name the preset and click **OK**.

Notice that when you are experimenting with ReaVerb you can:

- Drag and drop to change the order in which modules are positioned in the reverb chain.
- Untick the box to the left of any module's name to bypass that module.

Important note: Processing FX in general, and especially delay based plug-ins such as reverb, can place an especially heavy overload on your computer's CPU. In some circumstances it can be possible to partially offset this by enabling the **Preferences, Audio** option to **Reduce CPU usage of silent tracks during playback**.

Tip: When changing ReaVerb settings, stop and then restart playback for those changes to be employed.

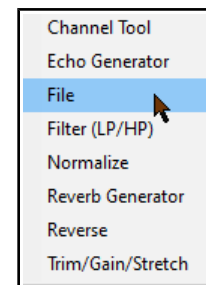
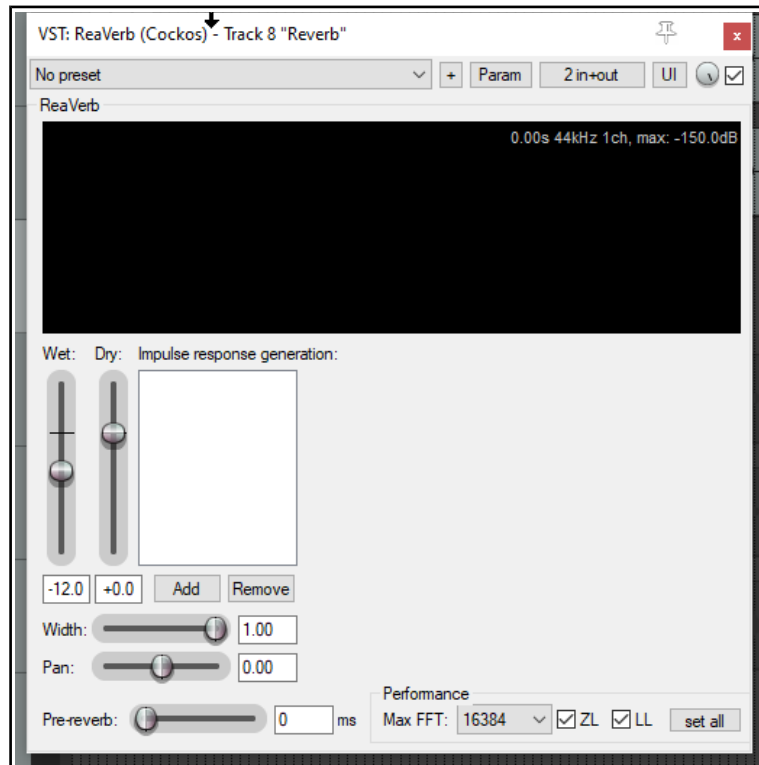

For a bound hard copy of the latest version of this User Guide (printed in B&W) go to LULU.com

REAPER Plug-ins in Action

ReaVerb Features Summary

Channel Tool – this advanced feature enables channel mapping and lets you combine multiple file by channel.

Options include swap, copy, add to, subtract from and convolve mode.

Echo generator - useful for "filling in the gaps" of an impulse or creating echo-decay.

File - inserts one or more impulse files.

High and low pass filter - force the impulse not to work above or below a certain frequency point.

Normalize - raise the gain of the impulse to 0dBFS.

Reverb Generator – to create artificial reverb based on length, room size, dampening, etc.

Reverse – reverses the Reverb – a nifty effect for vocals, guitar solos and song intros/outros.

Trim/Gain/Stretch – trim or stretch the impulse (make it shorter or longer), add in some graininess.

Max FFT – FFT filters are a complex mathematical topic. Google to learn more details! Meanwhile, for the rest of

us, changing the FFT size changes CPU usage. A lower FFT setting means a higher CPU usage, but spread more evenly. Higher FFT sizes will consume less CPU but result in more latency. FFT size will therefore affect performance and possible dropouts, but it should not affect the sound itself. If unsure, use the default setting.

ZL – option to enable zero latency: useful when tracking while monitoring reverb levels.

LL – option to use an extra thread to improve low latency performance.

When rendering, better results might be obtained with both ZL and LL disabled.

Set all -apply these performance settings to all instances of ReaVerb.

The **Bandwidth** determines how wide or narrow will be the frequency range that is compressed.

Threshold, Ratio and **Gain** work in the same way as in a normal compressor.

16.12 Noise Reduction with ReaFir

ReaFir is a multipurpose dynamics plug-in that almost defies categorisation or description. It can act as an EQ, a Compressor, a Noise Gate, and more. In this example, you will see how it can be used for noise reduction. The need for a noise reduction plug-in can arise when an otherwise good track has some unwanted background noise on it. This might, for example, be hiss or rumble, or the sound of an air conditioner.

ReaFir can be used to remove such sounds from your tracks in real time. In order to do this, you must first identify a passage on the track (perhaps a second or two) where you have recorded the unwanted noise by itself. This is likely to be at the very beginning of the track.

Example and Procedure

In overview, the procedure is this:

1. Insert **ReaFir** in the FX window of the track containing the recorded items with the unwanted noise.
2. Position the play cursor at the start of a passage containing just the unwanted noise.

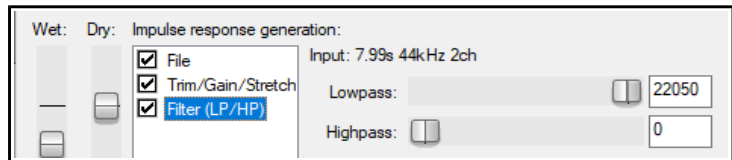
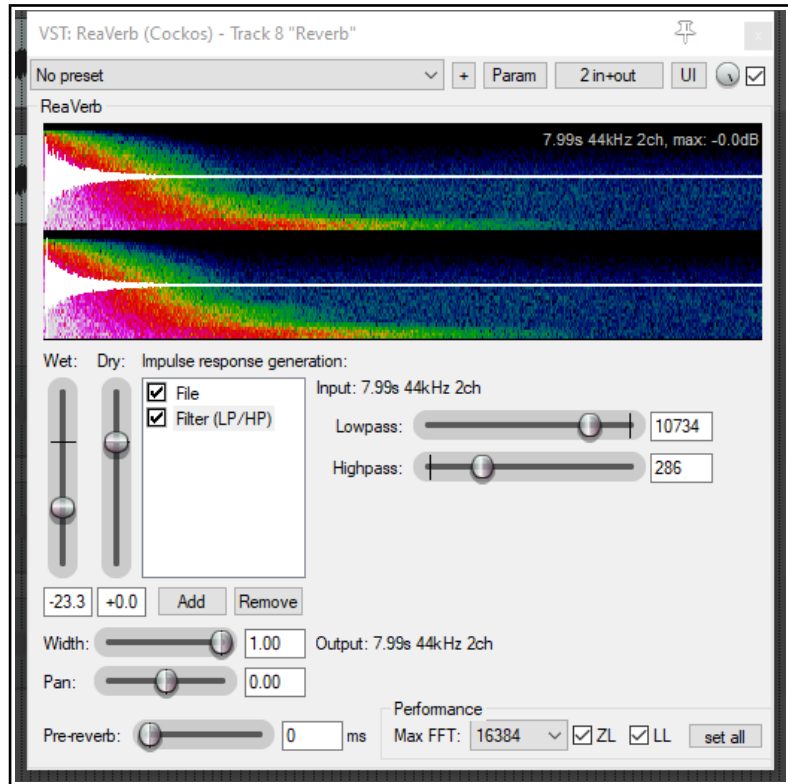

3. Set **ReaFir** to **Subtract** mode. Set Edit Mode to **Precise**.
4. Select the Option **Automatically build noise profile**.
5. Play the track only the part of the track that contains the noise, then stop the playback.
6. You should see that **ReaFir** has built a profile of the unwanted noise. This will be marked with a red line (shown right).
7. Now uncheck the box labelled **Automatically build noise profile**.
8. Return to the start of the song and play it.
9. As the song plays, the noise profiled by following steps 1. to 5. has now been removed from your output.

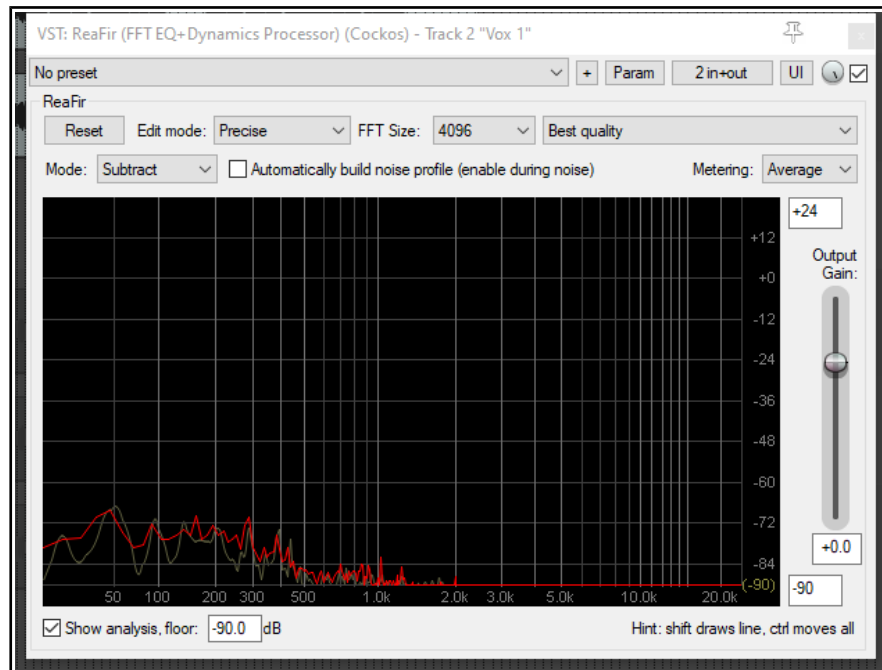

ReaFir supports **metering** in channel sum mode, max mode or selected individual channel mode. These modes are explained in the section covering **ReaEQ**. Your choice of metering options does not affect output. Your choice of **channel mode** (e.g. multi-mono or multi-stereo) from the right In/Out menu will, however, affect how the audio is processed. Channel modes are explained in the section covering **ReaComp**. If unsure, accept the default settings.

Note 1: ReaFir is suitable for removing a background noise that is fairly constant, such as an electrical hum: a noise gate is better at dealing with occasional noise, such as a vocalist's breathing sounds.

Note 2: As with other FX, ReaFir parameters can be automated (see [Chapter 18](#)). Moreover, of special interest to screen readers, is an additional automatable parameter, EQ curve offset, which adjusts the gain of the EQ, threshold or noise profile curve.

16.13 Multiband Compression with ReaXComp

Applied to the Master, Multiband Compression can be a useful tool for adding body, warmth and volume to your final mix. It is outside the scope of this guide to suggest just how heavily or lightly you should apply your Multiband Compressor. Many audio engineers believe quite strongly that the contemporary trend being currently pursued by the major record companies takes multiband compression too far.

Be that as it may, a multiband compressor works by applying different rates of compression to different frequency bands. This lets you shape the sound much more precisely than is possible with a simple compressor. The ReaXComp default settings include 4 bands. These are 0 to 200 Hz, 200 Hz to 1,000 Hz, 1,000 Hz to 5,000 Hz and above 5,000 Hz. However you can add extra bands or delete superfluous ones. You can also change the band frequencies as you wish. For example, if you increase the top frequency of Band 1 to, say, 250 Hz, then that automatically becomes also the starting frequency for Band 2.

If you have not used a Multiband Compressor before, then you are advised to start cautiously and become more adventurous as you gain in knowledge and confidence. You can experiment on any of the sample **All Through The Night** project files that you have used elsewhere in this User Guide.

Metering: As with ReaComp and several other Cockos plug-ins, ReaXComp allows you to choose which channel information is used for the visual display. This can be all channels (the default), all channels (with no FFT) or any selected channel. **Channel analysis** is explained earlier in this chapter where ReaEQ is discussed.

Channel Modes: Multi-mono and multi-stereo channel modes are also supported, as well as the default stereo mode. **Channel modes** are explained in the section where ReaComp is discussed.

REAPER Plug-ins in Action

Using ReaXComp: Some Tips

- Right-click over any band handle to display a context menu. Options include using **large band handles**.
- Don't use too many bands. Too many independently compressed bands can make your mix sound disjointed. Many mastering engineers use only as few as three bands.
- Listen closely to the changes in sound when adjusting settings. Take your time here.
- The Attack setting determines how much time passes after the signal rises above the threshold before the compressor kicks in.
- The Release setting determines how much time passes after the signal falls below the threshold before the compressor is released.
- Try to adjust the Attack and Release settings so as to make the compressor come in and out unnoticed.
- Especially when first using a Multiband Compressor in the Master, it is advisable to use the Gain settings only to compensate for loss of volume due to compression, not to pump the signal up. A notable exception here might be where one bandwidth needs to be adjusted slightly relative to the others.
- Consider placing a limiter (e.g. LOSER's Master Limiter) after the Multiband Compressor in your FX Chain.
- Another, and completely, separate use for a Multiband Compressor is to compress a very specific frequency within a track, for example as a de-esser or de-popper on a vocal track.

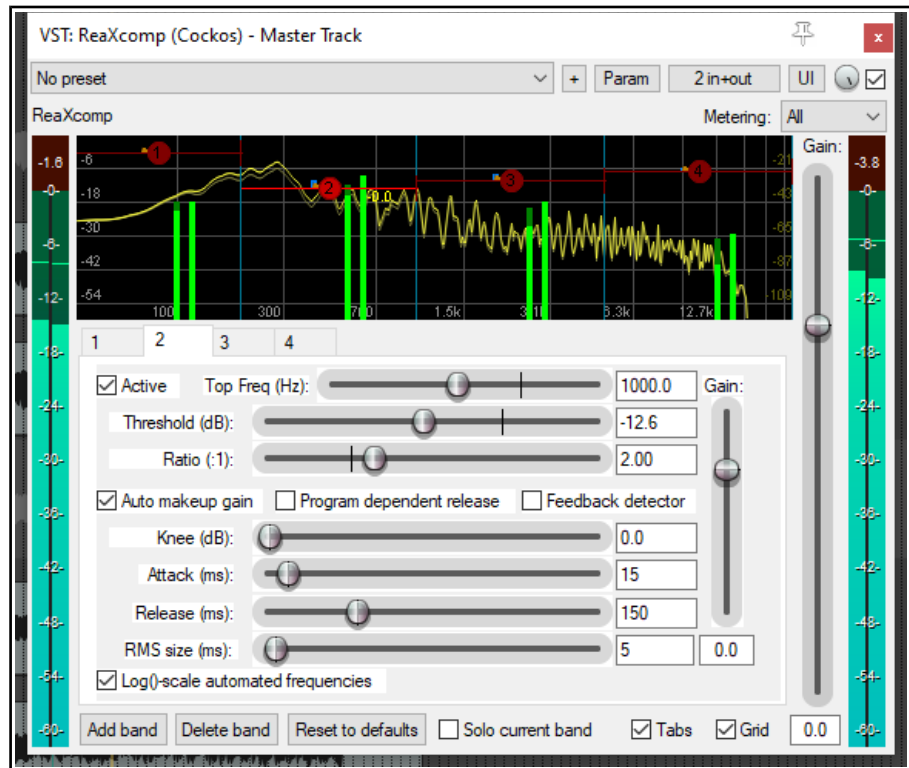

Note: ReaVerb, ReaFir, ReaXComp and the other Rea effects are described in more detail in the free **ReaEffects Guide** - <https://dlz.reaper.fm/userguide/REAPEREffectsGuide2021.pdf>

16.14 ReaLimit: The Brickwall Limiter

Reaper plug-ins are covered in [Chapter 16](#), but especially interesting is ReaLimit, which serves as more than a simple track or master limiter. It can be used on individual tracks, but is more likely to be used on the track master and possibly folders and submixes.

ReaLimit lets you specify a threshold and a ceiling: it then transfers sound from the threshold to the ceiling. Sound that comes in at the **threshold** goes out at the **ceiling**. No signal can be output above the ceiling: any input above the threshold is compressed. This usually results in a louder output. For example if the threshold is set to -6 dB and the ceiling is set to +0 dB, the overall signal is boosted by +6 dB to transfer the threshold to the ceiling. Input signal above -6 dB is compressed so that it peaks at exactly +0 dB.

ReaLimit's visual interface provides live visual feedback in real time. For a menu of display toggle options right-click over the graph. Your options are **Freeze display when playback stops**, **Clear display when playback starts** and **Autoscroll display**.

The **Metering** drop down allows you to choose which channel(s) is/are to be metered. The default is **All**. Note that channel selection here affects only the display, not the processing.

For a bound hard copy of the latest version of this User Guide (printed in B&W) go to LULU.com

Up and Running: A REAPER User Guide v 7.31

The In/Out right click menu lets you choose from stereo, multi-mono and multi-stereo. In **stereo** mode all master audio channels are compressed based on analysis of the loudness of all channels summed together. In **multi-mono** mode, each channel is analysed and compressed separately. In **multi-stereo mode**, each pair of channels is compressed independently as a stereo pair. Other features of the ReaLimit interface are:

Constant gain: manages threshold/ceiling controls so that either will be moved relative to the other.

True peak: whether to show true peak (a more accurate than peak). Double-clicking on either fader control will restore it to its default value.

Release: determines how quickly the limiter stops working after the signal drops below the threshold. If it is overly long, you will hear audible pumping, while if it is too short, distortion artefacts may result.

Performance: high quality (the default) or low latency.

Note that ReaLimit's application is not confined to your master. For example, it can be used with folders to help "glue" or pump up a submix, or on a per track basis with pre-mixed/bounced stems.

Track Gain Reduction Metering: Track gain reduction monitoring for plug-ins that measure gain reduction and report it to the host can be enabled in [Preferences, Project, Track/Send Defaults](#). Display the **Track meter display** dropdown and enable **Display gain reduction for plug-ins that support it**. Track meter defaults will be applied to new tracks only, not to existing tracks on existing projects.

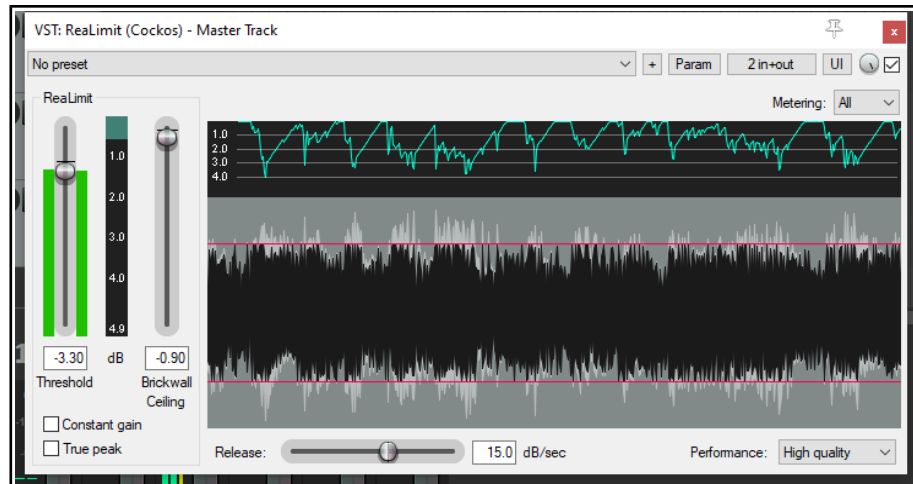

16.15 ReaTune Revisited

In Chapter 10 you were introduced to [ReaTune](#). ReaTune can be used to help you correct pitch on recorded media items. It can also be used to help you to tune an instrument – select the **ReaTune – Tuner** tab, as shown here (right).

Simply arm the track for recording in the usual way, then tune your instrument in front of the microphone. This is explained in detail in the free [REAPER Cockos Effects Summary Guide](#).

16.16 JS Plug-Ins and ReaPack: an Overview

The REAPER install package includes more than 250 mostly third party JS plug-ins which cover a wide range of functions. More are available by downloading and installing **ReaPack** from <https://reapack.com>.

Keith Haydon has undertaken the massive task of documenting many of them! You'll find his excellent and monumental work at <https://www.keithhaydon.com/Reaper/JSFX2.pdf>

When searching for possible JS plug-ins within the Add FX window, you can make use of the filter text box (for example **comp OR lim** to find all plug-ins with compressor or limiter in their name). There is also a menu option to show JSFX filenames as well as descriptions. See ["Using Search Filters"](#) section for more examples.

For the more adventurous, the **FX** menu in the Add FX window (**View, FX Browser**) includes commands to **Rename FX**, **Edit JS FX**, **Create new JS FX** and **Duplicate JS FX**

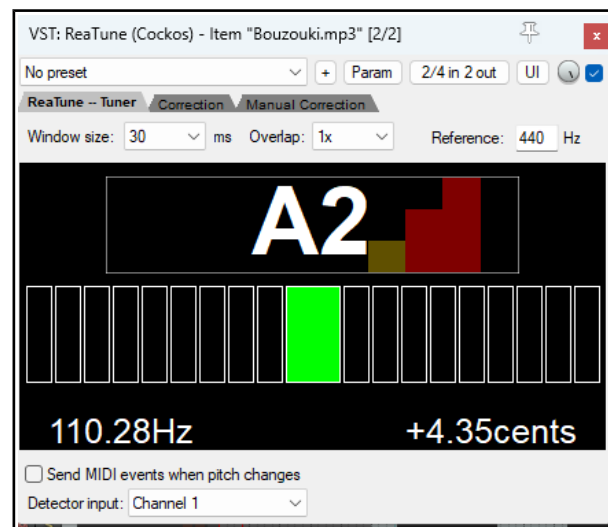

REAPER Plug-ins in Action

16.17 Summary Examples of JS Plug-In Categories

It is impossible to fit all JS plug-ins into tidy categories: the table that follows is indicative only. The order in which the categories are listed is not significant. Note, though, that the wider you cast your net when specifying a search filter, the more likely it is that your catch will include some that aren't relevant to your needs!

Category	Description
Eqs/Boosters/Filters	Includes semi-parametric and graphic EQ plug-ins, and a range of filters, boosters and exciters. Search example: eq OR filter OR excite OR shape OR boost
Compressor/Limiters	Includes expanders, drum and percussion compressors and various limiters. Example: comp OR lim OR expand
Chorus/Delay	Various niche chorus/delay FX. Example: chorus OR delay
Guitar FX	Enable the option show file names in JSFX list is enabled to find guitar FX. Example: guit OR flange OR fuzz OR phase OR trem OR wah OR distort
Analysers	Spectrum analyzers, Goniometers and more. Example: ana OR gon OR meter
Stereo manipulators	Enhancers, manipulators, fakers and more. Example: stereo
Pitch shifters	Pitch shifters. Example: pitch
Pan	Manual and auto-panners. Example: pan
Volume	Manual and auto volume adjusters. Example: vol OR loud
MIDI - See also MIDI plug-ins section of guide.	There is a very wide range of MIDI plug-ins. Search for MIDI together with any other term or terms – e.g. midi AND velocity
Channel split/join	This topic is covered in the section Channel Routing Plug-ins .

16.18 Bridging and VST Plug-in Run Mode

If you are using 64-bit REAPER and wish to use older 32 bit plug-ins you can do so by bridging. By default, REAPER will attempt to work out for you whether this bridging is required ([Options, Preferences, Plug-ins, Compatibility](#)). To override this setting for any plug-in, choose **Run as** from its context menu, then select one of three options:

Separate process: all bridged plugins for which this is selected will be put into a single process, external to the main Reaper process. This minimises CPU load: however, if one plugin crashes the bridge process, all the other bridged plugins will die too.

Dedicated process: this puts each bridged plugin into a separate bridge process of its own. This will prevent a buggy plug-in from crashing the entire bridge, but it has the downside of increasing the overall CPU load.

Native only: the plug-ins are run inside the main Reaper process.

Bridging can serve another useful function.

Even though it is primarily intended for use with 32 bit plug-ins, you can if you wish also bridge (most likely in a dedicated process) any 64-bit plug-in. This has the effect of firewalling REAPER against any adverse effects that could potentially arise from a buggy 64-bit plug-in.

A further choice, **Embed bridge UI**, determines whether the bridged plug-in GUI is displayed in the FX Chain wrapper window (or as a floating window) or is displayed in a completely separate (Windows / OSX) window. The choice is provided as some bridged plug-ins behave better in one context than in the other.

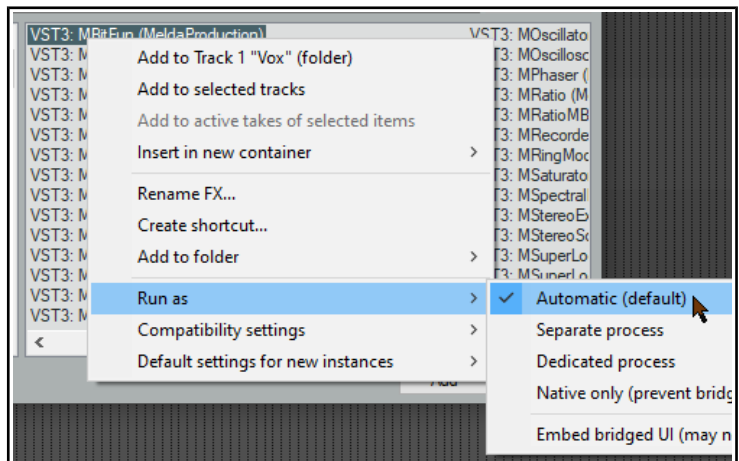

Up and Running: A REAPER User Guide v 7.31

The **Plug-ins, Compatibility** page of your **Preferences** option to **Terminate REAPER immediately if a plug-in corrupts the process heap** will cause REAPER to crash if it encounters a buggy or malicious plug-in.

Remember! You should not store 32 bit plug-ins in the same directory as 64-bit plug-ins.

16.19 Controlling FX Parameters on the Fly

If you have a [controller](#) (e.g. a Presonus Faderport), to assign a control on the fly to a VST FX parameter:

- In the FX window, click on the parameter control (e.g. for ReaComp, perhaps the Threshold fader).
- In the FX window, click on the **Param** button. Under Last touched, select **Learn** from the menu
- Twiddle the required knob on your controller and specify your MIDI/OSC Learn options.
- Click on **OK**.

16.20 Sending FX Output to a Different Track

Use REAPER's pin connectors. These are explained in detail in the [chapter immediately following this one](#).

16.21 Third Party Plug-in Presets

You can use your favourite third party VST and DirectX plug-ins with REAPER, such as Wave Arts, Melda, and so on. Many of these plug-ins are supplied with a number of presets. The method of accessing these will vary depending on such factors as the plug-in's native interface and which type of plug-in it is.

Many will access and save presets in their own interface, in which case their GUI will include a presets button and/or dropdown. If no such control is present, you **should** be able to manage the plug-in's presets using REAPER's interface (in the same way as you do for Rea and JS FX).

16.22 FX and FX Chain Options

The various menus in the FX chain window menu make available a number of options and preferences:

Options menu	Comments
Auto float new FX windows	Causes a new window to be opened for any FX added to the chain.
Ignore FX keyboard shortcuts	Keyboard shortcuts are all passed through to the main window – e.g. pressing spacebar will start/stop playback.
FX plug-in settings ...	Opens the Plug-ins page of REAPER's preferences.
CPU utilization display	CPU utilization (in the performance meter and elsewhere) can be displayed as a percentage of the total capacity of all cores (e.g. 10% as 10% of all cores), or in terms of the number of cores being utilised (e.g. 0.2c as two tenths of one core).
Individual FX context menu	Comments
Build multichannel routing for output...	If the selected FX (e.g. MT PowerKit) outputs to multiple channels, the necessary tracks are created for you, along with all required routing.
Build 16 channels of routing to ...	For input to multitimbral instruments, 16 tracks will be created, each with MIDI routed on a separate channel.
FX Menu	Comments
Chain PDC mode	Option for plug-in delay compensation to be calculated and applied to the chain or to ignore plug-in delay.
Chain oversampling	Oversampling can increase the rate at which audio is sampled by a factor of typically 2x or 4x that at which it was recorded. This can have the effect of reducing unwanted noise, but is also CPU intensive. Options available are 88.2k/96k, 176.4k/192k, 352.8k/384k, or 705.6k/768k.
FX instance oversampling	
Force auto-bypass on silence for selected FX	This can be used, for example, to prevent a reverb tail during a silent passage. The silence threshold is defined in advanced project settings . Also available on the individual FX context menu.

More Routing Examples

17 More Routing Examples

This section is mainly intended for more experienced users of DAW software. REAPER's [basic routing capabilities](#) include buses, submixes and folders. Tracks in REAPER can in fact carry up to 128 channels of information. These can be used for simple or complex routing of audio or MIDI material, making possible such features as FX routing, channel splitting and parallel routing, audio ducking and more.

17.1 Understanding REAPER's Channel Routing

Stereo (by definition) uses 2 channels - left (1) and right (2). When you pan a track with mono media, you are determining how that track signal is balanced left-right between these two channels. By default, REAPER uses channels 1/2 for your audio, e.g. when sending audio to the master. These same default channels are used by the master to send audio to your speakers. More complex tasks might need more than just these two channels. One example is parallel FX processing: for example, which allows different FX to be processed independently of each other. We'll get to this later in this chapter. Another example might be "ducking." This is where the volume of one track manipulates that of another – for example, to prevent a guitar from jumping up above a vocal.

Footnote: Your master has a virtual "switch box" (right click master volume fader). By default, channels 1/2 go outputs 1/2, but any combination of REAPER channels can be routed to any hardware outputs.

17.2 The Track Routing Button

Familiarise yourself with the TCP's track routing button ([Chapter 2](#)). This displays for each track one, two or three small "stripes" each of which will be on or off. The first of these (green) indicates whether the master/parent send option is enabled; the second (yellow) whether that the track has one or more sends; the third (blue) whether that the track has one or more receives. Hover the mouse over the button for a tooltip.

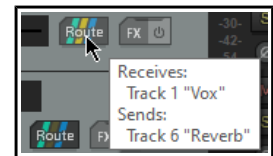

Clicking this button opens a window which reveals full details of any send from and/or receives to that particular track. You can also click and drag from this button to another track to create a send to that track.

17.3 Send and Receive Types

Every send is one of three types - **Post-Fader (Post-Pan)**, **Pre-Fader (Post-FX)**, or **Pre-Fader (Pre-FX)**. The default type is **Post-Fader (Post-Pan)**, but this can be changed in Preferences (Track/Sends defaults).

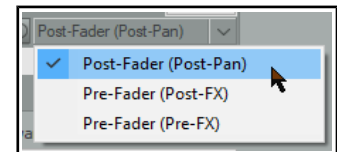

Different send types send the audio at different stages in the audio signal flow.

For example, the volume of a send that is Post-Fader (Post-Pan) will be affected by changes made to the source track's volume fader. A send that is Pre-Fader (Post FX) will not. An audio send that is Pre-Fader (Pre-FX) will be affected by the source track's volume fader but not by any FX in the source track's FX chain. For more complete information, consult the [flow charts](#) at the end of Chapter 6.

17.4 Pin Connectors and Channel Mapping

We encountered FX pin connectors and channel mapping earlier in this User Guide, in [Chapter 7](#). Channel mapping is accessed by clicking on a plug-in's In/Out button (typically labelled 2 in+out).

The **pin connectors** are like virtual cables, used in your FX to determine the channels that are used for the audio signal flow. This is shown in the pin connector interface.

Study the arrows and the black squares in the diagram (right). These indicate from which track channel(s) the audio comes in to, and

(after processing) goes out of, the FX. The first grid shows two separate audio streams from the track being input into an FX, from channel 1 (to the FX left input) and from channel 2 (to the FX right input). The second grid shows the output from the left FX channel passed to track channel 1, and from the right FX channel to track channel 2. What happens in between input and output is determined by the FX and its parameter settings.

Depending on the particular plug-in, you might have a choice of **channel modes**. These are explained in Chapter 16 in the context of ReaComp. For example, ReaComp and ReaGate support stereo, multi-mono and multi-stereo modes. ReaEQ and ReaVerb support stereo and multi-mono modes.

The **JS Channel Mapper Downmixer**, as its name implies, mixes channel inputs as required before passing the signal "downstream." Before looking at an example we need to understand a little more about the interface. By default, REAPER tracks comprise two channels (left and right). However, if the track has more than two channels then these channels will also be displayed in the plug-in pin connector.

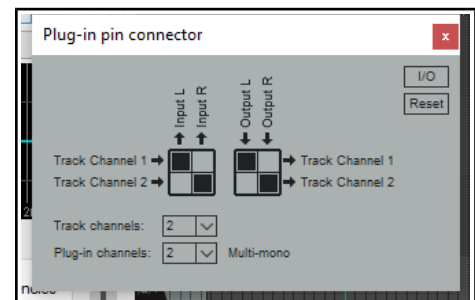

Up and Running: A REAPER User Guide v 7.31

The **track channels** dropdown can be used to increase or decrease the number of channels in the track (e.g. from 2 to 4 or 6): the **plug-in channels** dropdown defines the number of channels available in the plug-in. Remember that signal flow is sent from inputs to or removed from outputs by clicking in the boxes where the input/output combination intersects. In the example below, the track has four channels, but the plug-in has only two. The signal enters the FX from track channels 1 (L) and 2 (R) and after processing passes out to track channels 3 (L) and 4 (R).

This configuration can also be managed from the **I/O** menu (Audio input/output, MIDI input/output, plug-in channel configuration). **Help** is also available on this menu. Other **I/O** menu options include:

Delta solo (difference between dry and phase inverted wet). Toggled on/off by pressing **Alt click** on the FX wet/dry mix control. Allows you to hear only the difference a plug-in is making to the signal. Examples might be when soloing EQ bands to assess their effect, or when adjusting threshold, attack and release settings in a compressor.

PDC: whether to apply plug-in delay compensation.

Pass thru unmapped output channels or **Zero unmapped output channel**. Where a channel is not mapped (e.g. 1 to 1 and 2 to 2 in the second example above), whether to automatically pass the unprocessed signal thru to that channel.

The **Reset** button can be used to restore some or all settings to their defaults, or to clear settings. Options are:

Reset all **Reset input** **Clear input**
Clear all **Reset output** **Clear output**.

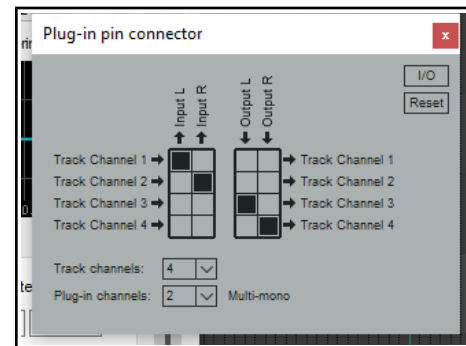

Example

This simple example is not necessarily something you will want to do, but it illustrates how pin connectors and channel mapping work. In it, we will be adding reverb to just one channel of a track.

1. Into an empty FX chain we insert **ReaVerbate**, display the pin connector and add two channels. Direct output to 3/4, as in the example *above right*. The option **Pass thru unmapped output channels** is enabled so that the dry signal will pass thru this FX unaffected.
2. We adjust the reverb parameters as required.
3. The **JS: Channel Mapper Downmixer** is added after **ReaVerbate**. Set it up so that the mixer channels 1/2 (dry signal) are passed to the track's channel 1 (left), and 3/4 (wet signal) are passed to the track's channel 2 (right).
4. We play the track, adjusting pan to suit, noticing that only the right channel will include any delay. Headphones are a good way to test this!

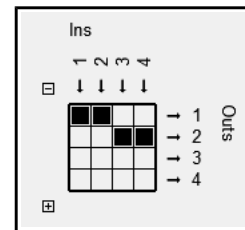

The JS:Channel Mapper Downmixer

This contains interesting features beyond being a simple channel mixer.

The options to **Pass thru** or **Zero out** act as explained above.

There are also a number of options for adjusting downmix levels (see right). Of these, perhaps the most interesting is the **User mix** option. This will present you with a series of faders that can be used to adjust the volume levels of individual channels.

Other options are None or -3dB or -6dB.

17.5 Sidechaining and Audio Ducking

The next example will show you how to use a technique known as **sidechaining** to create a **ducking** effect. Put simply, this describes what happens when a compressor is used to ensure that the volume on one track is automatically lowered whenever the volume on another track is raised.

You might want to do this, for example, when working with a kick and a bass. In this example, we'll use the Bouzouki, Guitar and Vocal tracks in our sample project to show you how it's done. We will use audio ducking to ensure that the overall volume of the instruments is automatically lowered a little whenever there is a signal on the Vocal track. This helps lift the vocal track slightly above the mix. In order to do this, we use multi channel routing in conjunction with the ReaComp compressor. The diagram below shows how we can do this.

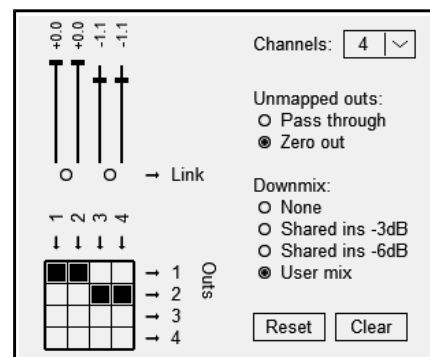

More Routing Examples

Example

1. Open the project **All Through The Night.RPP** and save it as **All Through The Night DUCK.RPP**.
2. Delete any tracks other than **Gtr Body**, **Gtr Neck**, **Vox** and **Bouzouki**. Make sure the track order is Vox Track 1, Gtr Body Track 2, Gtr Neck Track 3 and Bouzouki Track 4. Adjust the volume and pan faders as you see fit.
3. In the TCP, select the Vox track and press **Ctrl T** to insert a new track after this. Name this **Instrument Submix**.
4. Click on this track's **Folder** icon to make this track a folder. Make the Bouzouki the last track in the folder.
5. To add two more channels to the **Instrument Submix** to allow it to receive a sidechain signal from the Vox, right click on the Volume fader for this track and set the number of channels to four.
6. Next, display the FX window for the Instrument Submix track. Add the plug-in **VST: ReaComp (Cockos)**.
7. Now for the clever bit. We could add channels 3 and 4 to the Instrument Submix manually, as in the last example. We could also manually route an audio signal from the Vox track to the Instrument Submix, but REAPER provides us with a handy shortcut.
8. Drag and drop from the Vox track routing button to inside the ReaComp window. The routing control window that is automatically opened shows that this has been done.
9. This plug-in includes a setting called **Detector input**. This is where we tell REAPER that we want the Vox level, not the Bouzouki level to control when the compressor kicks in. This Detector input offers two main choices – **Main Input** and **Auxiliary Input**.
10. Display the **Detector Input** drop down list. Select **Auxiliary Input L + R** so that that the compression applied to the instrument mix will be controlled by the volume of the signal from the vox track on channels 3/4. When this exceeds the threshold, the instrument mix will be compressed.
11. Now play the song. Adjust the **Threshold** (first vertical fader) downward, so that during Vocal passages the VU meter peaks above the fader level.
12. Slide the **Ratio** fader right until you are satisfied with the overall reduction on the Instruments, probably be somewhere between 2:1 and 4:1. Observe the flashing red bar to the left of the Output mix VU. This shows how much reduction is being applied to the submix.
13. Save the file. Notice what is happening here: the volume signal from one track (the vocal) is triggering the compressor on the instruments folder.

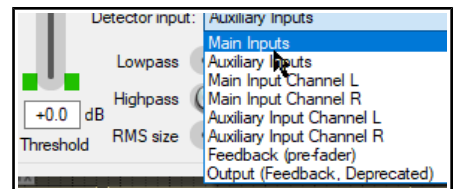
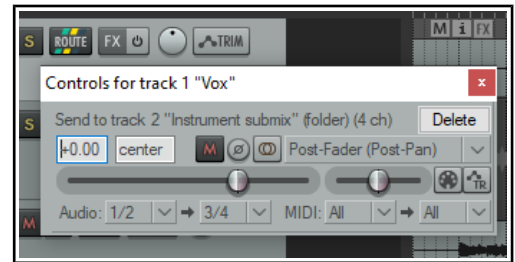
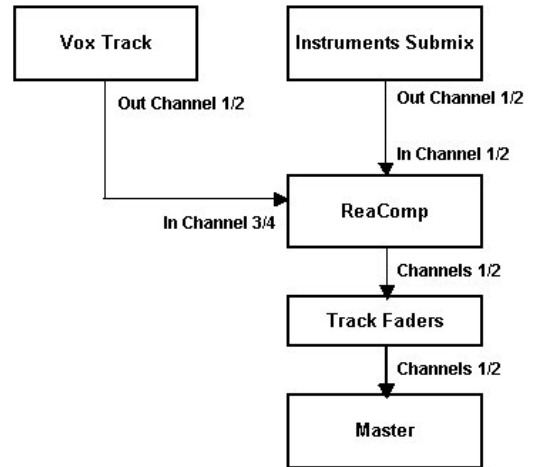

Shown below are possible compressor settings that might be appropriate in this case. The trick is not to overdo the compression, but to have it just lower the peaks of instrument mix a little to make room for the vocal. This same technique can be applied to other REAPER plug-ins that support sidechaining, including ReaGate and several JS plugins, such as Major Tom Compressor and Express Bus Compressor.

17.6 FX Containers and Parallel FX Processing

Introduction

This advanced topic is not really suitable for beginners.

REAPER's FX containers allow you more flexibility and a greater capability in creating and managing FX chains than simply running two or more **FX in parallel** with each other. This advanced topic might take a little longer for you to get your head around. It's more appropriate for experienced users than for beginners.

To understand FX containers and how they work, let's look at an example (right).

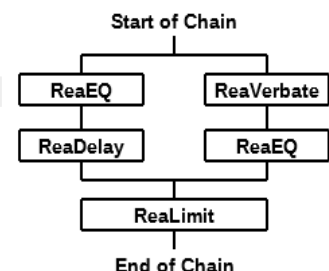

Up and Running: A REAPER User Guide v 7.31

In this example, as in the others, the actual FX being used are for illustration only and are not the focus of the exercise. What matters is the technique, which could be applied using other FX of your choice. What we have here is two parallel FX *chains* rather than just two parallel FX. To achieve this, REAPER will:

- ◆ Pass the audio signal into a *container*.
- ◆ This container will need to consist of enough channels as are needed to allow for (in this case) two parallel chains, i.e. four channels in all, one pair for each chain.
- ◆ As the audio stream exits the container, the outputs of the two parallel channels will need to be merged as they are passed on thru channels 1/2 of the FX chain to any subsequent FX (in this example, ReaLimit). To recap, channels 1/2 are used by default by the track to send audio output to the master.

So, to summarize, a container will need enough inputs and enough channels (in this example, four) to allow the different streams to be processed independently of each other, and enough outputs (again, in this case four) to allow the streams to be merged as they exit the chain.

That's a lot of theory to take in! Let's see how it's done in practice.

Example 1

To set up the FX container described above:

1. Click on the track's **FX** button, then **Add**, then from the displayed list of FX double-click on **Container**. A container is added to the FX chain and its empty window displayed. Immediately after the container, in the far left column, add **ReaLimit**. Select the container. Your track FX window should now resemble that shown on the right.
2. Click on the *container's* button labeled **2 in+out** to open its pin connector window. Here you can define its parameters. We'll get to the pin connectors shortly. First, notice that by default the container inherits the same number of input/output channels as the track – in this case two.
3. Set the number of container channels, inputs and outputs to (in this example) 4 and complete the pin connector matrix as shown here (right). Instead of 2 in+out, the connector button will now read **2/4 in+out** as shown below right.
4. This directs input from track channel 1 to container inputs 1 and 3, and from track channel 2 to container inputs 2 and 4.

Output from container channels 1 and 3 will pass to track channel 1, and output from container channels 2 and 4 will pass to track channel 2.

5. Using the **Add** button *in the container* window we can now insert the required FX into the container's FX chain – for this example ReaEQ, ReaDelay, ReaVerbate and a second instance of ReaEQ. Your FX window should now resemble that shown (right).

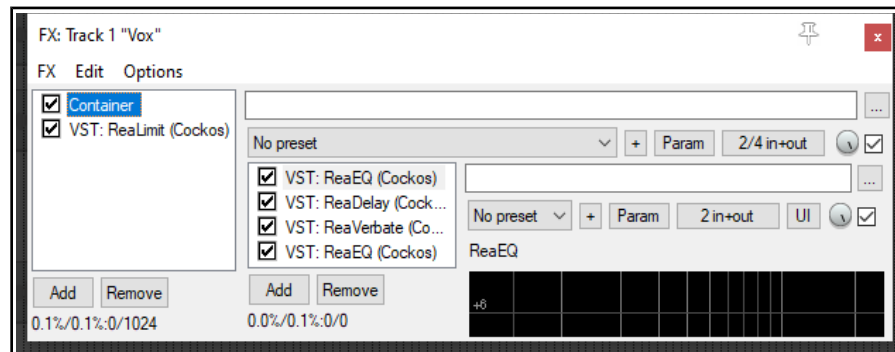
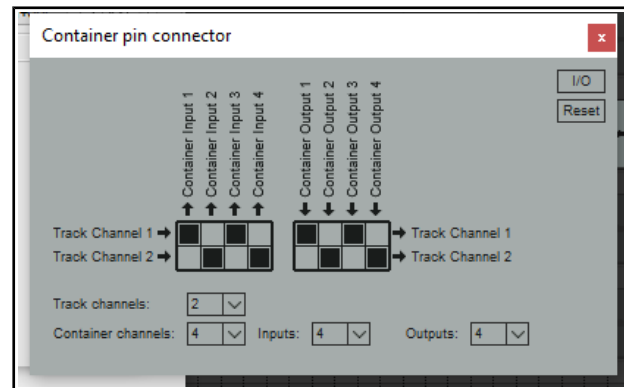
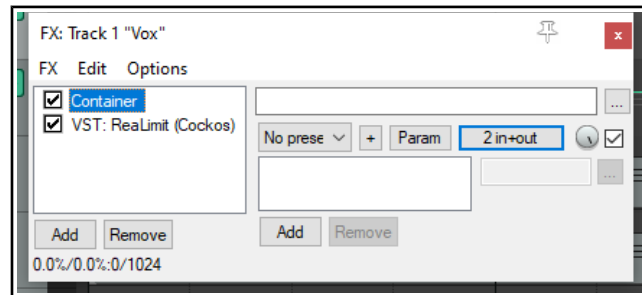

More Routing Examples

- The pin connectors for the first two container FX will both need to be set to receive input from and send output to container channels 1 and 2 only, as shown here (below left).
- Similarly, the pin connectors for other two FX will both need to be set to receive input from and send output to container channels 3 and 4 only (below right).

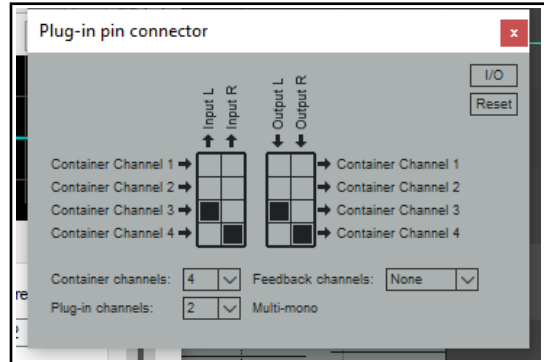
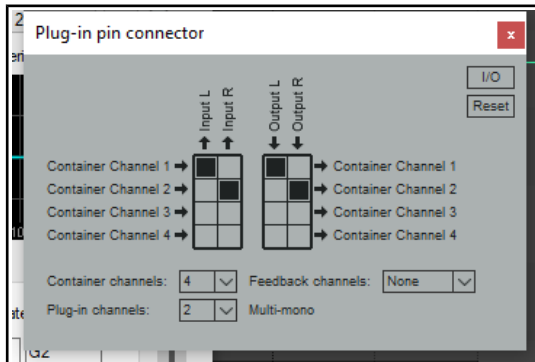

- Finally, you can experiment with adjusting the various FX parameters – and save this file as a model that you might find useful for future use.

Note: A new container can be added to an existing FX chain by choosing **Add FX container** from the FX menu. You can also create a new container from this menu by selecting any FX or selection of FX in the chain and choosing **Move to container** from the FX menu.

Example 2

In this example we will split an audio stream into two chains – left and right – and apply separate FX to each stream before returning the signal to the FX chain, one FX to channel 1 (left) only and the other to channel 2 (right) only. A possible application for this technique could be on a vocal, using one EQ instance to add body, the other to add clarity.

In this case, the pin connector numbers should be left at its default settings – two container channels, two inputs, two outputs.

The pin connector settings for each of the two EQ instances could then not be simpler. The first takes its input from and sends its output to channel 1 only (as shown here).

The second takes its input from, and sends its output to, channel 2 only.

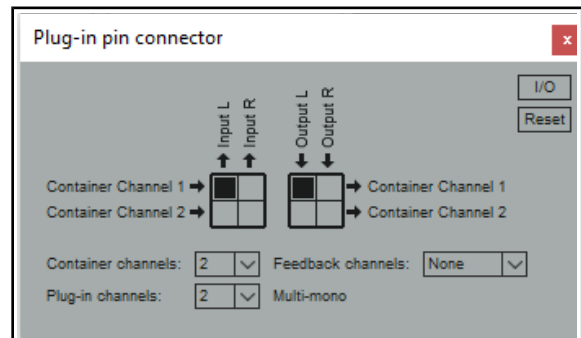

More Complex Applications

FX containers are handy, but even they do have their limitations!

More complex models can be created using REAPER's pin connectors – for example, fine tuning your parallel processing requirements, or directing the output from some FX to a different track. For these and other related topics refer back to to the [JS: Channel Mapper-Downmixer](#).

Tip 1: FX containers can be even more powerful when combined creatively with other REAPER features. For example, you can have two or more containers [running in parallel](#) with each other!

Tip 2: You can select any FX or number of FX in a track or item's FX chain, then choose **Move FX to container** from their right-click context menu to move those FX into a new container.

Tip 3: An entire container, complete with its FX and its routing, can be saved as a preset which can be recalled into other tracks and in other projects.

17.7 Sending FX Output to Another Track

You are able to send of any track FX output directly to any other track, instead of or as well as to itself. Consider an example such as this. You have a track, say a mandolin, with an FX chain that includes eq, EQ and compression. You want to create a send to, say, a reverb bus track, after the EQ and compression. In this case, simply place the EQ first in the chain, and leave its output at the default, channels 1/2

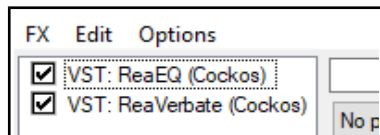

Here is another example. Left is shown an FX chain for (say) Track 1 of a project. Reverb is applied after the EQ. You could send the reverb output directly to another track instead of track 1, to further work on it there.

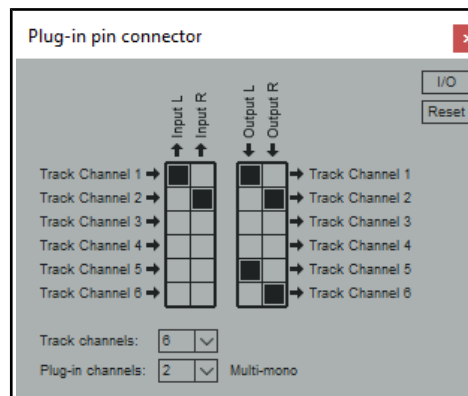

To do this, click on the **2 in/out** button on the FX interface. Select the EQ and direct its output both to channels 1/2 and to any other available pair (e.g. 7/8), as shown (right). Now select the Reverb plug-in and use its pin connector to direct its channel input from and output to only (in this example) channels 7/8.

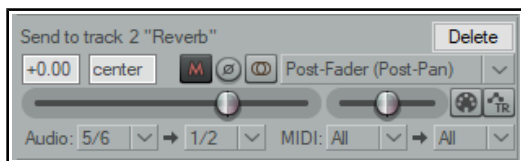

We can then create a new track – for example, Track 2 immediately after the current track) and create a send from channel 5/6 on the source track to channels 1/2 on the new track. Solo track 2 to hear the reverb by itself.

17.8 Other Channel Routing/Mixing Plug-ins (Overview)

Here is an overview of some of REAPER's other channel routing/mixing plug-ins. You can always check the web sites and the forums for the latest information. This section introduces you to some other plug-ins (not used in these examples) that are specifically designed for use in a multi-channel routing environment.

JS: 8x Mono to 1X Stereo Mixer and JS:*x Stereo to 1X Stereo Mixer

Similar to each other, but allows eight separate stereo or mono audio streams to be mixed into one.

JS 8-Channel Input Switcher

This is a channel switching utility. Output Source selects which of up to four paired inputs channel is to be monitored, and the Level faders adjust the gain independently for each pair. Useful for A/B comparisons.

JS SwixMitch

This crossfade utility allows you to feed up to four input pairs to two busses then mix those busses to output channels 1+2. The destination for each of the four paired inputs can be set to Off, A, B, or A+B.

JS Channel Router w/ Polarity

Takes an input channel pair signal and modifies the phase according to the selected mode. The modified signal is output on the selected output channels. Only the selected output channels are modified so, for example, a signal received from inputs 1+2 and output on 3+4 will still be present in its original form at outputs 1+2.

The Input and Output parameters select which paired channels are used for input and output. Phase Mode can be set to No Change, Invert Left Channel Only, Invert Right Channel Only or Invert Both Channels.

17.9 Further VSTi Signal Routing

The same technique that is used to [send FX output to another track](#) can also be used to send the output of a VSTi instrument before FX to another track, whilst also leaving the FX on the VSTi track. This is one possibility:

Click on the **track channels drop down** and select the number of channels required (for example, 6). In the track routing window you can then create a send from those channels (5/6) to channels 1 and 2 on another track.

VSTi output will now be directed without track FX to the other track, as well as (in this example) with track FX to the VSTi host track (via channels 1/2). With up to 128 channels available, you will not lack flexible options!

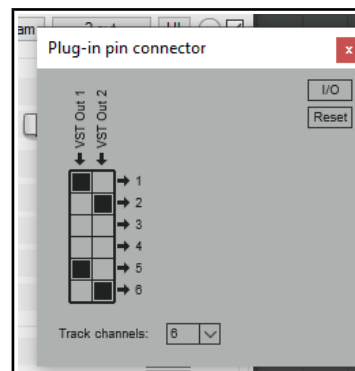

More Routing Examples

17.10 Round-Robin Multisampling

The round-robin option can be used in conjunction with the probability setting to determine whether any given instance will produce a sound from any given note. For example, at 100% it will play every note. At 50% it will ignore every other note. Round robin makes the application of probability somewhat deterministic. If you have, for example, a 20% chance, round-robin will ensure a response exactly every 5th note. With round-robin disabled, each note is independently randomized. Consider an example where you use a separate track for each percussion instrument – kick, snare, etc.

Shown here is a simple arrangement for the snare track, with two instances of ReaSampleOmatic5000, each containing a separate and subtly different snare sample.

For both instances, **round-robin** and **Remove played notes from FX chain MIDI stream** have been enabled. For Snare 1 probability is set to 50%, for Snare2 100%. This ensures that during playback each of the two instances (and therefore two samples) will be used alternately, in rotation. If in this example you had three samples rather than two, probabilities would be set at 33% (1 in 3), 50% (1 in 2) and 100% (1 in 1) respectively. For four samples, these settings would be 25% (1 in 4), 33% (1 in 3), 50% (1 in 2) and 100% (1 in 1), and so on.

More complex variations are possible. For example, a JS: MIDI/midi_choke plug-in is available which can be used in conjunction with ReaSampleOmatic5000 to help control whether any sound will be produced from a given note.

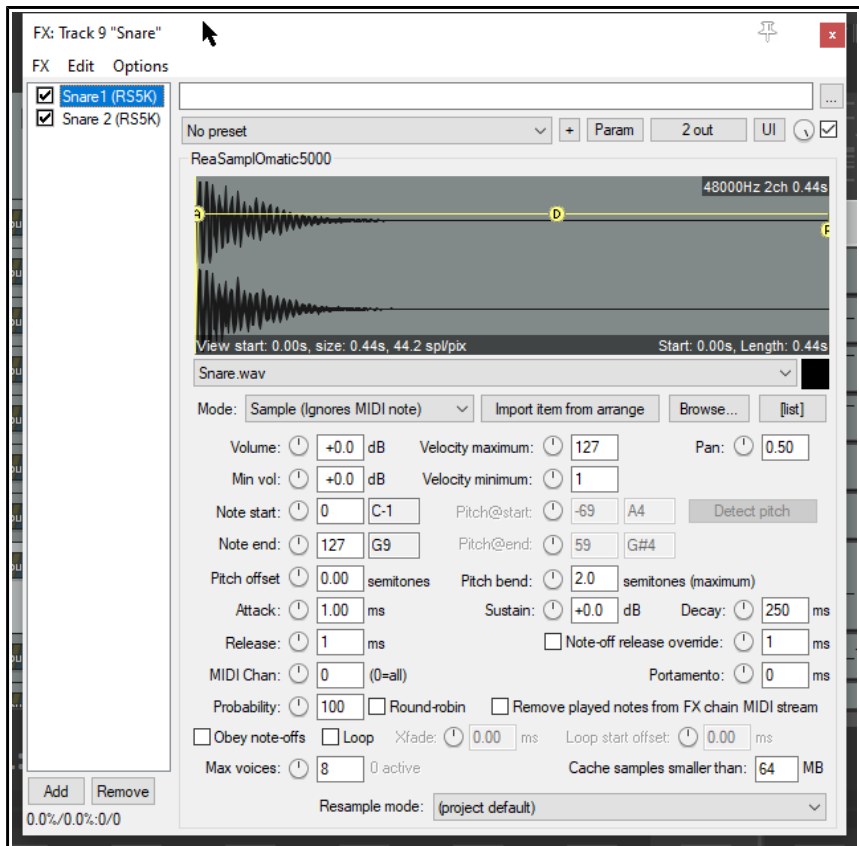

An example showing how this can be used can be seen here:

<http://forum.cockos.com/showpost.php?p=1278385&postcount=28>

17.11 ReaSamplomatic and ReaDrums

This example uses the **ReaSamplomatic** plug-in provided with REAPER in conjunction with the **ReaDrums** track template created by **jamester**. You can download this template from the REAPER Stash on the REAPER web site. To check the current address for this, visit the REAPER Forum and check jamester's signature, or do a search. After downloading, it should be copied into your Track Templates folder. For XP users, this is **C:\Documents and Settings\User Name\Application Data\REAPER\TrackTemplates**

The template does get modified from time to time, so that the version that you download might not be exactly the same as the one used in the description that follows. This should not matter. Also, in the example, we will use the **MIDI Editor** for demonstration purposes, but if you have a keyboard, you can use that instead.

Example

1. Create a new empty project file and save it as **ReaDrums Example.RPP**
2. Right click over the Track Panel Area and from the menu choose **Insert track from template** then your **ReaDrums** template. Notice that a track will be inserted, with eight individual named instances of **ReaSampleOmatic5000** inserted in its FX chain.

3. Notice that each instance of **ReaSamplOmatic5000** is set up differently. From top to bottom, these are *Kick, Snare, Perc 1, Perc 2, Perc 3, Perc 4, HH Cl, HH Op*. Near the bottom left corner you can select a MIDI channel for each sample. The default is 0, which means all channels. Shown here is the Snare, which has been set to channel 1. In this example, an audio sample has also been inserted. That's the next step!
4. Display the Media Explorer – **Ctrl Alt X** – and select a folder where your samples are stored.
5. In the ReaDrums FX window select the item Kick. From REAPER's media explorer window you can drag with your mouse the required sample file and drop it into the ReaSamplomatic window, in the black area above the Browse button.

Alternatively, you can either use the plug-in's **Browse** button to make your selection, or select any existing item in Arrange view and click on **Import item from arrange**. Another option is to click on the **[list]** button to open a window to build up a list of samples. This can be sorted by file name, or by peak or RMS values.

6. Repeat this process in the other seven ReaSamplomatic instances, one at a time, for each of the other instruments, each time inserting a different appropriate sample. If you wish, rename any of the ReaSamplomatic5000 instances to reflect the sample name.

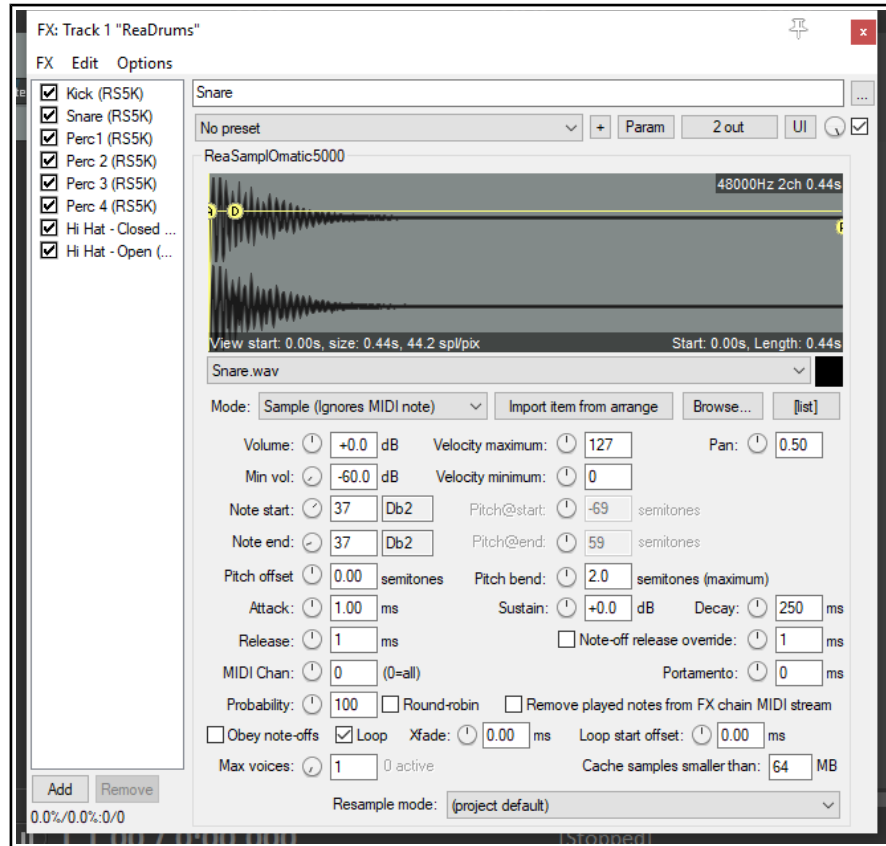

7. Notice that each instance of ReaSamplomatic5000 uses different **Note start** and **Note end** settings. This makes allows the notes (and any other events) for the different instruments to share a single MIDI item.
8. Make sure the ReaDrums track is not record armed. Save the file.
9. Along the timeline select the first 10 seconds or so. With your ReaDrums track selected, choose the **Insert, New MIDI Item** command to insert a MIDI item.
10. Double click on this item to open the MIDI Editor. From the menu choose **View, Piano Roll Notes, Triangle** and **View, Mode, Named notes**. If necessary, scroll up or down to display your samples. For each sample, its row number will correspond to its ReaSamplomatic5000 note start/end setting. For example, in this case the snare (shown below) will be row 37.
11. Compose a few notes, similar to the concept shown below. Make it a simple composition of your own.
12. Close the MIDI Editor and save your file.
13. If you wish, you can also use REAPER's channel routing to send different parts to different tracks, where you can add FX, adjust panning, volume, etc. Let's suppose we wish to apply some FX to the kick and the snare individually. Right click over the Volume fader for the ReaDrums track and set the number of channels to four. We'll start with just one or two.
14. Press **Ctrl T** twice to add two more tracks. Name the first of these tracks **Kick**, the second **Snare**.
15. In the **ReaDrums** track set the number of Channels to 4, and create a send to the new **Kick Track** (using channel 3) and the **Snare Track** (using channel 4).
16. Open the **FX Window** for the **ReaDrums** track.

More Routing Examples

17. Select the first **ReaSamplomatic5000** instance, the **Kick**. Set both of its VST Outs to Channel 3.
18. Select the **Snare ReaSamplomatic5000** instance and set both of its VST Outputs to Channel 4.
19. Now play the music. Notice that the Kick and the Snare have been rerouted to their respective tracks. You could now place any FX that you wish in the FX windows for those tracks. Save the file.
20. If you add more channels to the original ReaDrums track, you can now repeat this effect for any other of your Drum parts.

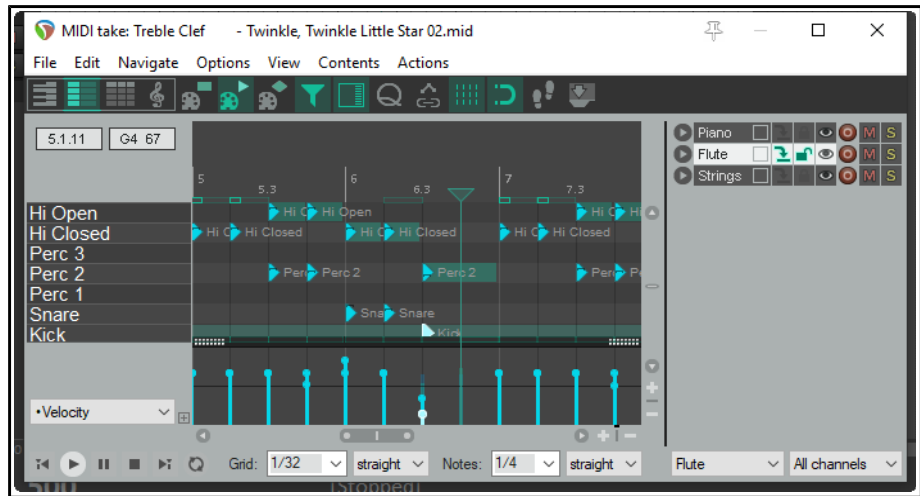

Tip: If you download the track template **ReaDrums Rack** from the REAPER forum, you will find that in this template all the individual tracks, along with their routing, have already been set up for you.

ReaSamplomatic5000 is a very powerful and flexible piece of software. Its many capabilities and applications extend well beyond the simple example outlined above, and beyond the scope of this User Guide. They could well command an entire manual in their own right! For example:

- Each instance of ReaSamplomatic5000 has its own independent set of controls (volume, pan, pitch bend, attack, sustain, release, decay, etc).
- Changes made to the attack, delay, sustain and or release settings will be represented on the graph (envelope) that is superimposed on the sample waveform in the ReaSamplomatic5000 window.
- The **Max Voices** rotary can be used to select any number between 1 and 16. However, if you need more than 16 you can type in any number up to 128. This, for example, allows ReaSamplomatic5000 to be used with long cymbal rides. Notice too that the number of active voices is shown during playback next to the max voices value.
- For most of the controls you can create arrange view [automation envelopes](#) and/or control them using [parameter modulation](#). These topics are explained in Chapters 18 and 19.

17.12 REAPER's Routing Interface

When using multiple track channels with sends and receives you might wish to consider keeping the Routing Matrix in view. You can use your routing matrix to make adjustments to any of your sends and receives, or to specify the number of channels required for any track. Some examples are summarised below.

Right click over any track name (as shown above right) to display the Track's Routing Window and change the number of Track Channels, or to adjust the parameters of any Send or Receive associated with that track.

Right click over the Send/Receive signal at any intersection on the Routing Matrix to adjust any of the parameters for that Send or Receive (as shown below right). Click over any vacant intersection on the Routing Matrix to create a Send/Receive at that point.

Remember, of course, that you can also create, remove and manage sends and receives in the TCP and the MCP. In either case, you can click on any track's **ROUTE** button to

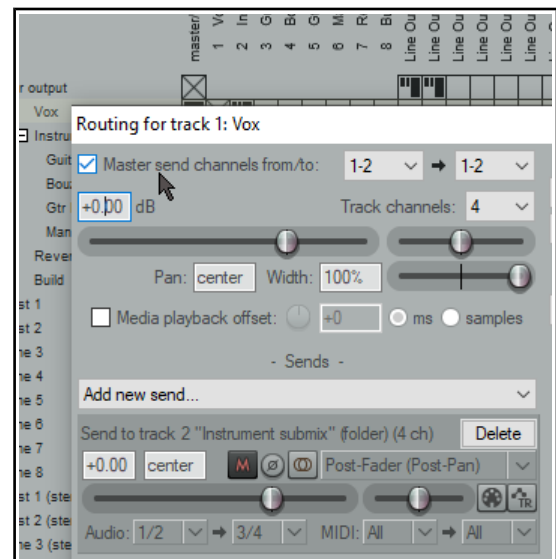

For a bound hard copy of the latest version of this User Guide (printed in B&W) go to LULU.com

Up and Running: A REAPER User Guide v 7.31

display that track's Routing Window, or right-click over the **ROUTE** button and use the fly out menu to easily add a Send or Receive.

Tip: Sends can be copied in the Routing Matrix from one track to another: if you have created a send from (say) track 1 to (say) an effects bus on (say) track 6, then to create similar sends from other tracks you simply drag and drop that send up and down the matrix column.

Note: The Routing Matrix right-click context menu can be used to limit what is shown as destinations and as sources – for example, any combination of master/parents, tracks, audio hardware outputs, MIDI hardware and MIDI channels. There are also options to display (or not) tooltips and input activity indicators. The latter causes MIDI and audio input rows to light up in response to any input signal

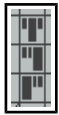
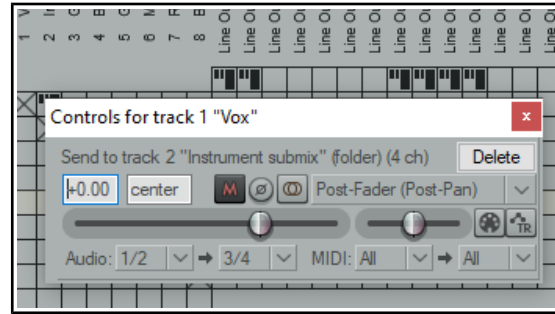

Note: The three different send types are shown in the Routing Matrix by the symbols on the left. From top to bottom these are **Pre Fader (Post FX)**, **Post Fader (Post Pan)**, and **Pre fader (Pre FX)**. In each case, the height of the large thick bar indicates the send volume level. The [flow charts](#) in Chapter 6 will help you to understand the differences between these.

17.13 Surround Panning with ReaSurround and ReaSurroundPan

REAPER includes two plug-ins for surround mixing – ReaSurround and the more fully featured ReaSurroundPan. It's advisable to read thru this entire section before deciding which is most suited to your own needs.

Surround sound production is a complex topic. It would be beyond the scope of this User Guide to attempt to cover the principles, theory and practical issues that it involves. Whole books have been written on the subject: you can also consult various web resources, such as "The Recording Academy's Producers and Engineers Wing Recommendations for Surround Sound Production" (available as free PDF download). This section is intended for those who are familiar with the principles of surround mixing and who need to know how to put these into practise within REAPER.

REAPER's surround sound production capabilities can be found in three main areas:

1. Producing music in multichannel format. For [how to do this](#) see Chapter 3.
2. REAPER's channel routing capabilities. Remember that you can use item channel mapping to assign the output of different media items to different channels.
3. The ReaSurround and ReaSurroundPan are in many respects similar, the most important difference being that ReaSurround is a spatial positioning plug-in, whereas ReaSurroundPan is a multi-channel panner.

REAPER-specific issues that you need to be aware of for surround sound production are:

Configurations

Both plug-ins support several surround sound configurations, such as 5.1, 7.1 and 9.1. Specify your number of input channels and select your required configuration from the drop down list (for ReaSurround, shown here). In addition, ReaSurroundPan also supports surround 7.1.2, 7.1.4 and 3D ITU and Auro options. You can also specify your own custom arrangements, by selecting User Setup (ReaSurround) or Custom Speakers (ReaSurroundPan) from the speakers dropdown.

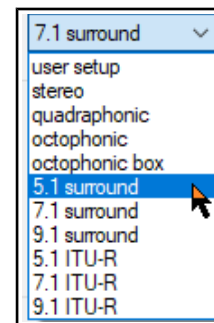

Recording

Record each track using the settings most suitable for that track. For example, for a lead vocal you might use a two channel track with a single mono input (one mic). For a piano, you might record in stereo with two mics. For ambient sounds you might prefer a four channel track with four mic inputs.

ReaSurround

Routing

ReaSurround, like any other plug-in, can be inserted into a track's FX chain from the FX Browser. REAPER then offers you various routing options.

More Routing Examples

For example, you can insert ReaSurround into each track individually, with each one directly routed to the master. Another option is to create sends from all tracks to a single surround mixing bus and use a single instance of ReaSurround there, disabling direct sends from individual tracks to the Master. In some respects, the former method might give you greater flexibility and more control but there are other advantages in folding down multichannel audio to fewer channels.

You will also need to set up the necessary routing for your master outputs to ensure the correct signal flow from your master to your surround speakers. Channel input pucks can be positioned by clicking and dragging them across the display. See also tips below. In addition, there are two further sets of controls in the ReaSurround window. The three **Edit** drop down lists and their accompanying rotaries can be used as controls with any three of the available items shown (below). These vary according to the selected format. For example, for 5.1 they are:

Left/Right	Front left/Back right	Diffusion bias	To front center
Back/Front	Expand/Contract	Diffusion rota	To back left
Low/High	Rotate	To front left	To back right
Back left/Front right	Diffusion level	To front right	

These are explained in more detail in the section **ReaSurroundPan**.

Tips for managing inputs

As a rough guide, when mixing in 5.1 or 7.1 you can create individual stems or submixes of dialog, music and sound effects, then start according to these guidelines:

Dialog: 100% center

Foley effects: Front L/R panned to phantom center

Hard effects: 100% front L/R plus 50% LFE

Backgrounds/Ambience: 50% front L/R, 50% sides/rear

Music: 75% front L/R, 25% sides/rear

Speaker influence can be set to **Relative** or **Absolute**. For example, if set to absolute, you should be able to position a sound between (say) left front and center speakers without any sound leaking to the right.

The three horizontal **Space size** faders can be used to adjust the three dimensions of the surround environment, width, depth and height, with the fourth fader acting as a zoom control.

The various **Inputs** and **Outputs** controls can be used to mute, solo and or adjust the levels for Gain or Low Frequency Effects (inputs) or Gain or Influence (Outputs).

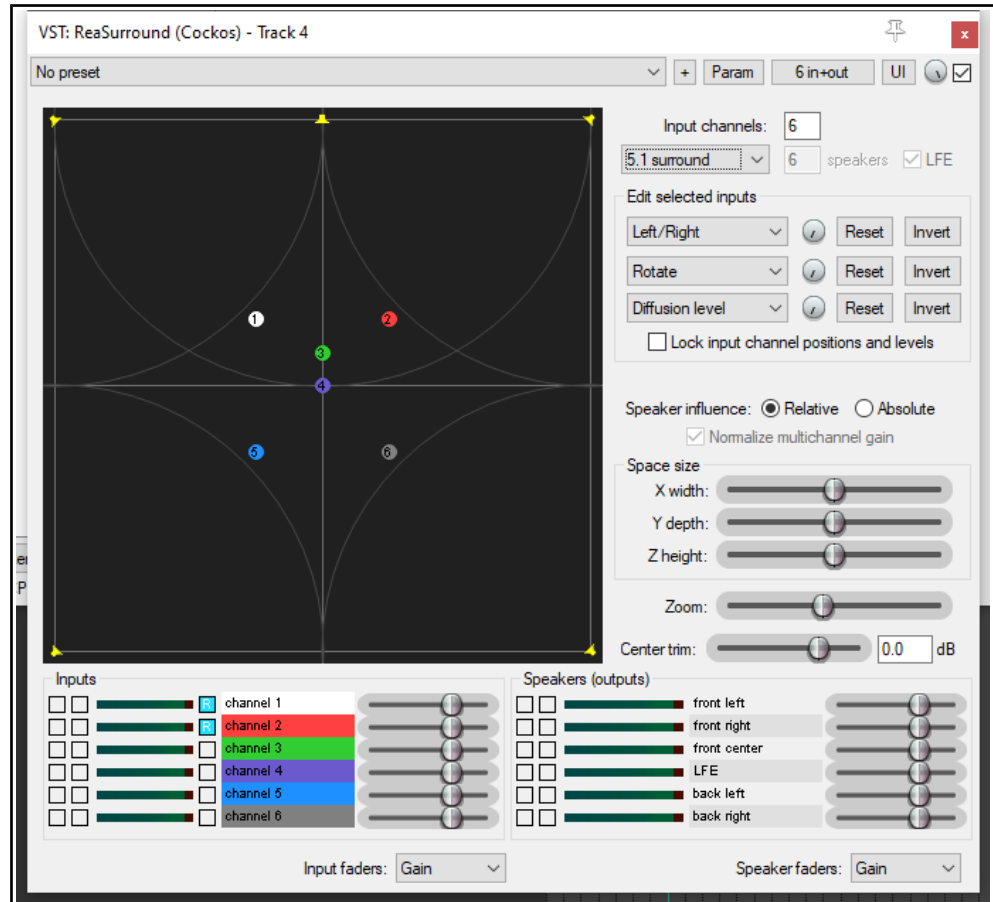

Up and Running: A REAPER User Guide v 7.31

When adjusting controls, holding **Shift** will make the control respond more swiftly: holding **Control** will slow it down. Double-clicking a control returns it to its default setting.

You can select two or more input "pucks" (control click or marquee to make selection) and move them together. Clicking the **R** button for any input(s) will cause it to mirror (reverse) the movement of the other input(s) in the selection. Holding **Control** while dragging will temporarily disable the mirroring.

Invert can be used to move the left/right rotate positioning of a puck to its mirror image.

Lock, as its name implies, locks pucks into their current position to prevent accidental movement. Other controls are summarized below.

In the example shown above, the Surround Panner has been inserted into a "normal" two channel track with a mono recorded media item.

The Surround Panner therefore finds – and displays – only two inputs this time.

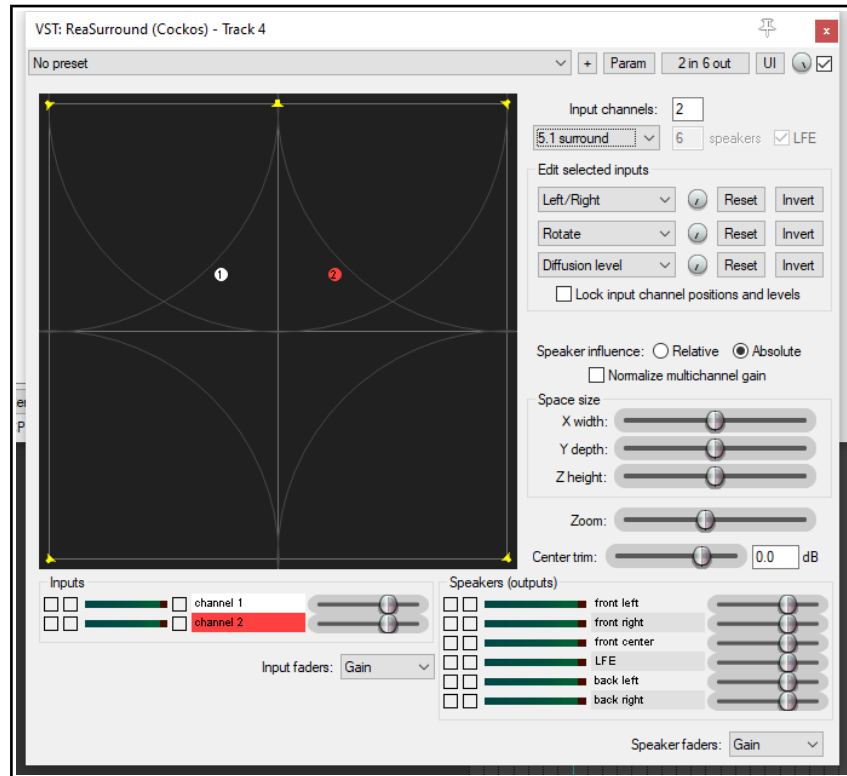

Because 5.1 surround has been selected as the surround mode, even though the input is in mono, it can nevertheless be directed to any or all of the six outputs shown. You also have an additional option to **Normalize multichannel gain**. See also Chapter 21, [Surround Rendering](#).

Additional ReaSurround Controls

Influence: each speaker has an influence area: when an input puck (the numbered circles representing the input channels) is within a speaker's influence area, then that channel is heard through that speaker.

Diffusion: each input has a diffusion level: when diffusion is greater, the input puck is effectively "larger" and therefore overlaps with the influence area of more speakers, so it is heard through more speakers. For example, with a simple stereo setup, an input that is panned hard right is only heard through the right speaker because it's only within the right speaker's influence area and not within the left speaker's influence area. If the diffusion of that input is increased it will eventually also enter the left speaker's influence area

LFE: this represents a low frequency effects channel, a non-directional output channel like a subwoofer. The LFE speaker is not displayed as a puck, but you can mix inputs into the LFE output via the input sliders.

ReaSurroundPan

ReaSurroundPan gives you more mixing options than does ReaSurround. It is an ideal tool to use, for example, when mixing sound for games or movie soundtracks. It supports most if not all commonly recognised formats (see illustration, right).

Its basic controls are much the same as you'll find in ReaSurround. For example, you select your required format from the drop down and then specify the number of input channels.

The mixing window

The mixing window displays a different colored puck for each channel. The color coding used is indicated in the Inputs section (bottom left of window). The number of pucks shown will be determined by the number of channels that you specify in the **Input channels** box.

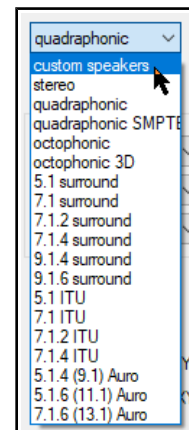

More Routing Examples

Any of the small box diagrams just below the mixing window can be selected to change your view of the sound field and the positioning of the various channel pucks within it – for example, from the front, from the side or from the top. The first of these is the default, which shows the mix from above. The second offers a choice of two dimensional view, the third three dimensional views, again from the front, the side or from above.

Moving the pucks

Click on any puck to select it. You can marquee (right click drag) to select a number of pucks, or use control click to select a number of pucks, or use control click to build a selection. To move your selection, drag any item within it in one of the mixing window displays, or use any of the three rotary controls, which by default are set to left/right, rear/front and low/high. The reset buttons restore selected pucks to their original position in that plane. Note that a LFE channel would not normally be panned because the wavelength is so long that it is difficult for the human ear to discern which direction it is coming from.

Individual pucks can also be moved by selecting the channel from the dropdown and typing in XYZ co-ordinates. X represents left/right, Y front/back and Z low/high. The range for both X and Y is -100 to +100, and for Z 0 to +100. These settings become especially interesting when we look at flipping (below).

Restricting Puck Movement

As with ReaSurround, the function any of the three dropdowns that control the rotary controls can be changed by making a different selection from its dropdown list. For example, by selecting rotation for one of the dropdowns you could ensure that that control could be used to cause the selected puck or pucks to be rotated - see options list on the right.

Edit Option Controls

These are reasonably self-explanatory. The radio buttons offer you the choice at any time of moving all pucks by moving any one, or moving only those you have selected.

Enabling **Lock** prevents any puck from being moved, and the **1D edit** option can be used to restrict movement to a single plane.

XYZ Flipping

This feature is enabled or disabled according to your **Respect XYZ flip** setting. It allows you to mirror movements for whichever inputs you are moving.

For example, if you first select two channels and then enable X flipping, you can drag one so that they move further apart from each other, or closer together.

The XYZ Angles

The XYZ, XY°, and Z° edit boxes allow you to enter an exact position for any input puck, either as cartesian or spherical coordinates.

The **Center** and **Side** faders can be used to attenuate speakers that are closer to the center front/center rear, or side left/side right. This enables you to create the effect of width without needing to move any of the input

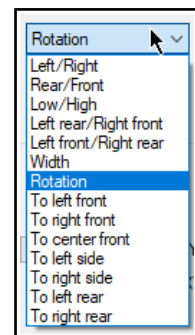
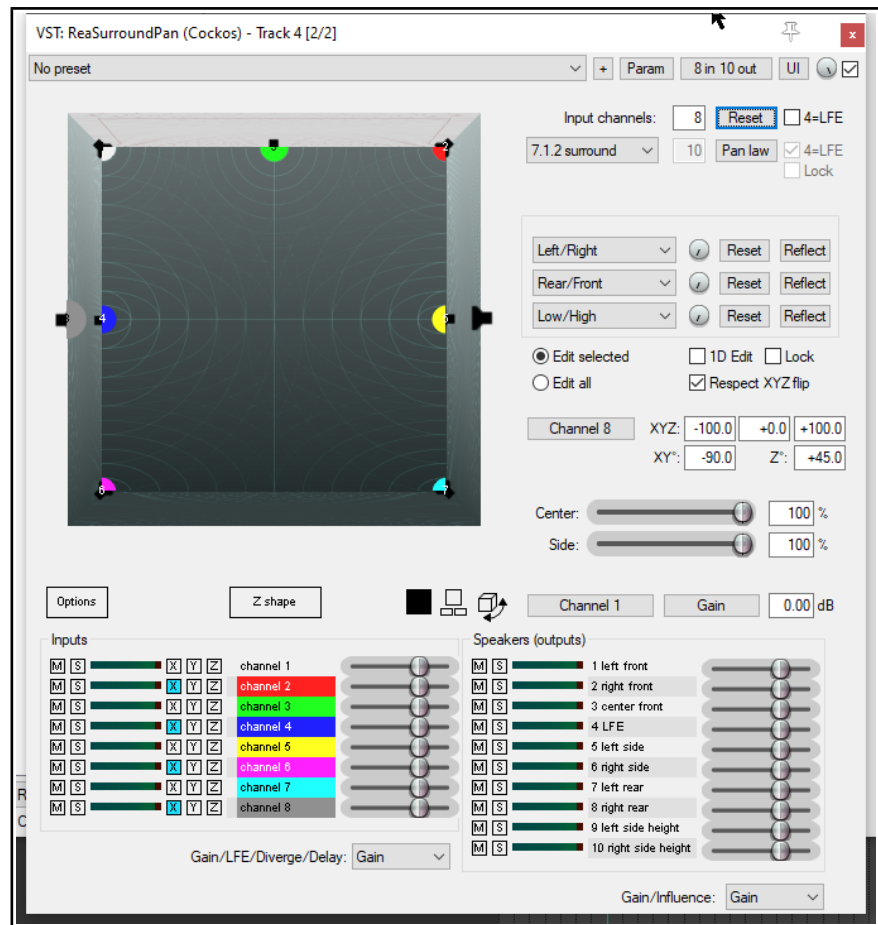

Up and Running: A REAPER User Guide v 7.31

pucks. If either or both of these is disabled, it means that this feature is not possible with your selected format. For example, 5.1 surround does not support side speakers.

Channel Input Faders

Each of these multi-function faders has four states – Gain, LFE, Divergence and Delay. You can select any of these functions from the drop down box (which defaults to Gain).

LFE can be used to send input from that speaker to the LFE. Divergence can be used, for example, to send a sound to the left and right so that it comes from the center but appears to be from a wider source. Delay can be used to add the Haas effect to a channel.

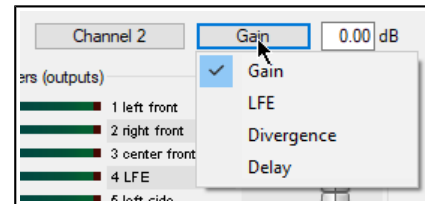

Speaker Output Faders

The same drop down can also be used to select a required function for the dual function Speakers (output) faders. The two options are Gain and Influence.

Automation

Any parameter control can be automated to be applied during audio playback. To select a parameter for automation, click on the **Param** button (top right), then choose **FX parameter list**, then **Show track envelope**, then select the required parameter. Also, parameter modulation can be used to link parameters so that one effectively controls the other.

17.14 Routing to/from Other Applications with ReWire

All of the examples up to now have involved routing audio or MIDI data within REAPER. We're now going to take a look at how your music can also be routed to and from other applications.

For users of ReWire, REAPER supports ReWire (2.6). ReWire is jointly developed by Propellerhead Software and Steinberg to allow applications to share audio, MIDI and synchronization data. Audio and MIDI data are transferred between the two applications in real-time, allowing you to use the features in each application as if they were one. See: <http://www.propellerheads.se/technologies/rewire/>

ReWire functionality is automatically installed along with REAPER on the MacOS. Windows users need to make sure when installing REAPER that they have ReWire selected and enabled on the **Choose components** page of REAPER's Install wizard under **Additional functionality**.

In a ReWire session, the first application acts as the host, and the second application acts as the client. The client receives and sends signals via the host application. REAPER can be used as either host or client.

The ReWire system uses mixers, panels, and devices. Mixers are the host applications which typically do the sequencing at one end and the final

mixdown at the other end. A device is a dynamic link library that only generates sound but has no user interface of its own.

A panel is a graphical interface for setting the parameters of one device. For example, you might use REAPER as your mixer and Propellerhead Reason as your synthesizer.

In this case Reason would provide device and panel to REAPER, which could then send midi commands, sync timing and mix Reason's output into its own effects chains.

ReWire can be used with any track(s) in a REAPER project. Display the track's FX chain and select ReWire from the list of plug-in categories (left column). This will display (in the right column) a list of all ReWire enabled applications that have been installed on your computer. Select the application ("client") that you wish to use – for example, this might be ReWire Ableton Live, Rewire Reason or (as shown here) ReWire FLStudio.

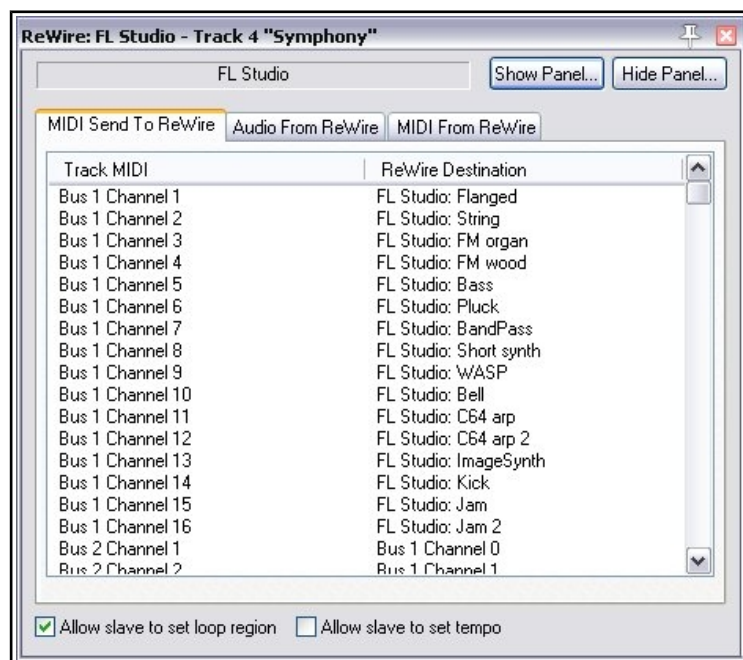

More Routing Examples

Selecting your ReWire enabled application will cause the application to be opened. You can use ReWire to send MIDI data to the client application (as shown here), to route audio from the client application into REAPER, or to route MIDI data from the client application into REAPER.

By default, the tempo for both applications is set by the ReWire host. However, there is an option in REAPER's ReWire window to allow the client application to set the tempo.

Note 1: There is an option (**Options, Preferences, Audio**) to **Close audio device when inactive and REWIRE devices are open**.

Note 2: REAPER can be opened in client mode from the Windows Start, All Programs menu, or by first opening the host application and by selecting REAPER as the client application there. You can also (in both OSX and Windows) ReWire REAPER to itself by choosing Rewire REAPER from the Add FX window. For more information about using ReWire with REAPER see: wiki.cockos.com/wiki/index.php/ReWire

17.15 MIDI Routing and MIDI Buses

REAPER's 128 MIDI Buses vastly increase your MIDI routing options. Each bus can carry up to 16 channels, offering you 2048 virtual MIDI channels in all.

MIDI Buses can be used to direct MIDI data to specific instruments, e.g. on a single track ReaSynth or ReaSamplomatic. It becomes more useful with multi-timbral software (e.g. Kontakt).

You can also use MIDI buses to send MIDI CC messages, including to specific FX. When you create a MIDI send, as well as the usual channels 1 to 16 you have the option of selecting any of the 16 channels on any of the 128 MIDI buses. In the example shown (above), B4 means use bus 4 on current MIDI channel, 4/2 means Bus 4 channel 2.

REAPER's native MIDI routing capabilities are as powerful and as flexible as its audio routing capabilities. The exact method is different, but the concepts are similar. This is quite a complex topic. Make sure you are familiar with REAPER's general routing

essentials described in this chapter before you attempt it. REAPER uses MIDI buses to overcome the limitations imposed by the standard of 16 MIDI channels. REAPER's 16 MIDI buses extend this capability. Each bus can handle up

to 16 channels of MIDI data, making available to you 2048 virtual MIDI channels in total! If no MIDI Bus is specified, then for plug-ins the default, Bus 1, is used. Using MIDI buses any track can receive MIDI data from and send MIDI data to as many or as few of these channels as you wish. For example, using MIDI buses you can:

- Host multiple VST instruments on a single track. You can "team" them so they can share the same MIDI data and "split" them so that each receives different MIDI data on its own dedicated MIDI bus, as well as sending MIDI data on any of the MIDI buses to other instruments on that track.
- Route MIDI Continuous Controller ("CC") data to specific plug-ins (instruments or FX).

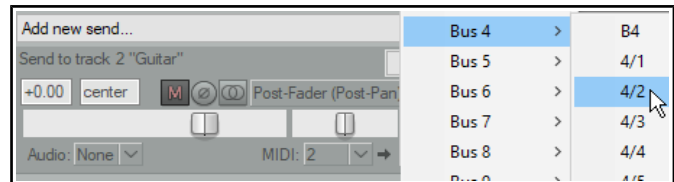

Up and Running: A REAPER User Guide v 7.31

- Have more options for using parameter modulation to allow the MIDI data generated by manipulating one instrument's controls to also be passed via a MIDI bus to another instrument. This will be explained shortly.

When working with plug-ins in an FX chain, MIDI data can be placed on a MIDI Bus in two standard ways:

1. Using the track's Routing capabilities: the MIDI data sent can be filtered by MIDI channel or MIDI Bus or both. That filtered MIDI can be sent as filtered or to a selected MIDI Bus or channel or both, or
2. Setting the MIDI Output for a plug-in: the MIDI can be sent to any MIDI Bus (the MIDI channel cannot be specified, that is determined by the plug-in).

Note that only standard MIDI events (that is, those on MIDI Bus 01) can be edited in the MIDI Editor Piano Roll. The MIDI data on the other MIDI Buses is conveyed in MIDI SYSEX messages and is displayed in the SYSEX lane in the MIDI Editor. You could edit those messages in that lane or in the Event List. Keep in mind also that MIDI buses can convey not only CC messages but also notes and other information.

Example 1: Sending and Receiving MIDI Data

Let us look at the track send / filtering possibilities first (above right). Here are four sends from track 1:

1. The Send to track 2 sends all the MIDI data.
2. The Send to track 3 sends all the MIDI data on MIDI channel 6 only, regardless of the MIDI Bus.
3. The Send to track 4 sends all the MIDI data on MIDI Bus 2 only, regardless of the MIDI channel.
4. The Send to track 2 sends all the MIDI data on MIDI channel 4 on MIDI Bus 3 only.

And now, the receives. Here are four receives on track 15:

1. The Receive from track 11 receives all MIDI data, MIDI Buses and channels are unchanged.
2. The Receive from track 12 receives all MIDI data and changes MIDI channel to 8, MIDI Buses unchanged.
3. The Receive from track 13 receives all MIDI data, placing it on MIDI Bus 3, MIDI channels are unchanged.
4. The Receive from track 14 receives all the MIDI data, changes the channel to 6 and places it on MIDI Bus 5.

As you can see, Reaper offers a powerful mechanism for filtering MIDI events and rerouting that filtered MIDI.

Example 2: Teaming Multiple Instances of ReaSynth

The Model

This will show you how to team a number of instruments together in a single track so that they work together to produce your music. For the sake of simplicity we will use just two instances of ReaSynth, but we could choose to use more if we wished. This is best understood by working thru a relatively simple example.

Using MIDI buses, we can route the four MIDI tracks shown here (each with data on a different channel) to a single audio track which will contain our two VST instruments and several VST audio plug-ins. In this example, each of the instances of ReaSynth uses different parameter settings. We wish to set this up so that the output of tracks 1 and 2 goes to the first synth, and tracks 3 and 4 to the second synth. MIDI buses allow us to do this, and effectively use the two synths almost as if they were a single multitimbral instrument.

The Routing

We start by inserting the two instances of ReaSynth into the FX chain of a new track. We can rename them as ReaSynth 1 and ReaSynth 2. Of course, you can use different instruments if you prefer. We can then open this track's routing window and create sends/receives along the lines shown here.

Different combinations of MIDI data are sent to two MIDI buses – Bus 2 and Bus 3. Each of these buses will be assigned in turn to one of the two synths – Bus 2 to ReaSynth 1, Bus 3 to ReaSynth 2. We could have used whichever buses we liked, although for reasons that we'll get to later you might wish to avoid Bus 1.

1. All the MIDI from track 1 is received on channel 2 on bus 2.

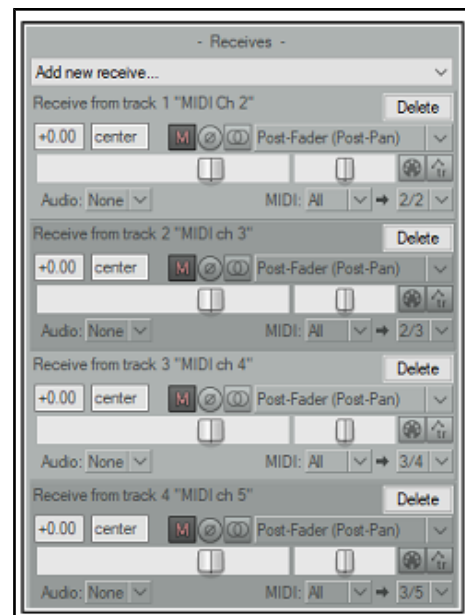

More Routing Examples

2. All the MIDI from track 2 is received on channel 3 on bus 2.
3. All the MIDI from track 3 is received on channel 4 on bus 3.
4. All the MIDI from track 4 is received on channel 5 on bus 3.

We have used different MIDI channels so that the sources can be distinguished, if needed. ReaSynth processes MIDI on any channel. If you were using a multitimbral plug-in, such as Kontakt, SampleTank or Falcon, then the plug-in would receive all the MIDI data on the selected Bus (or that on Bus 1, if none is selected) and the MIDI events on the different channels would drive different instruments / sounds loaded within the plug-in.

Assigning the Buses

The next step is to assign a separate bus to each of the synths. First, we can select ReaSynth 1, then right click on the Routing [2 out] button, then select MIDI input, then MIDI Bus 2. We can repeat this process to assign Bus 3 as the input for ReaSynth 2.

We can then add whatever audio FX we like to the FX chain – e.g. stereo width and reverb and play back the music, adjusting any of the synth or FX parameters at will. If you wish to use different FX on the audio from each synth you can make the track multi-channel and connect the synths and FX to the appropriate audio channels, [as described in channel splitting](#) earlier in this chapter.

Example 3: Driving Multitimbral Samplers

We can take the previous example further and replace those instances of ReaSynth with (say) Kontakt and SampleTank respectively. For Kontakt, we could set its MIDI Input Bus to 2 and load two instruments into the rack, set one to MIDI chl 2 and the other to MIDI chl 3. For SampleTank, we could set its MIDI Input Bus to 3 and load two instruments into the instrument slots, set one to MIDI chl 4 and the other to MIDI chl 5.

On playback you would hear all 4 different sounds, each driven by its own original source track. And, of course, the combined audio can be further processed with FX. In theory, you could have 16 multitimbral plug-ins, each on a different MIDI Input Bus, and with 16 different sounds loaded in each plug-in. That would provide 256 different sounds, but it would be rather a cacophony.

Footnote: A huge thank you to Michael Schnell and DarkStar for their inexhaustible patience and invaluable help with the production of this section.

17.16 Multichannel Parent-Child Relationships

Parent-child track relationships can be defined in the [track's routing window](#), opened by clicking on its Route button in the track panel.

By default, REAPER assumes that you require two channels (1-2)

for new tracks, and 2 channels (1-2) for the master.

These channels (in this example 1 and 2, because that is all there are) are used to send output from the track to its parent (which in this example is the master, as shown above right). The first of the paired dropdowns determines and indicates the channels used to send output from the track to the master, the second indicates the channels on the master to which they are to be sent.

Note that the parent will not always be the master. An example is when the track is contained within a [folder](#). In this case, instead of *Master send channels from/to* the dialog will display *Parent send channels from/to*, and the output will be directed to the folder track, not directly to the master.

There might be occasions when you will need more than two channels – for example when sidechaining, using parallel FX processing, or if you are producing output in surround sound format. In any such case, you will need to specify the number of track channels required and their relationship to their parent.

Example 1:

In this case the track has four channels (perhaps reserving channels 3-4 for [sidechaining](#) detector input), but only channels 1-2 are to go to the parent (master). We select 1-2 from the first dropdown, and from the second dropdown we select 1-2 as our destination channels in the master.

Example 2

This next example would be suitable for [surround mixing](#) in 5.1 format. The master has been defined as having six channels, as have the tracks. Hence, from the first dropdown we can select either All or 1-6 channels: 1-6 is automatically selected for the second dropdown, because once we have specified that we wish to send all 6 channels that becomes the only possible option.

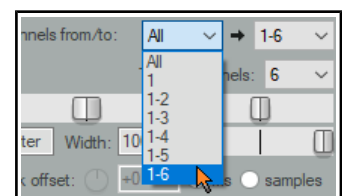
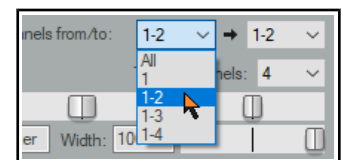
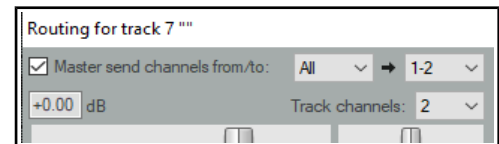

Example 3

This final example is for a child track within a folder. The track itself has only 2 channels, but the folder has 4 (perhaps for manipulating FX within the folder's FX chain). Here we select All or 1-2 from the first dropdown: because this track has only two channels, in this case either of these will produce the same result.

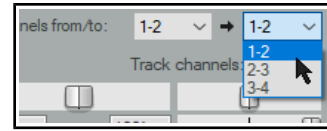

However, because the parent contains four channel, we must also specify the destination channels on the folder. If you do not make a selection, it will default to 1-2.

Tip: You can change the number of default channels for new tracks to any even number up to 64 on the Advanced page of [Project Settings](#). Here you can also change the default number of parent send channels.

17.17 Multi Output VSTi Plug-ins

This section shows you how to set up multi-output VSTis.

Example 1: Paired Audio Tracks

1. Right click over the empty area of the Track Control Panel and from the menu choose **Insert virtual instrument on new track...**
2. When the FX browser window is shown, double-click on the required instrument. This example uses the 8-output version of **Grizzly** (4 stereo channels). You could use any multi output instrument that you wish.
3. You will be asked to confirm whether you want the appropriate number of tracks built for the particular instrument that you have chosen (above right). Click on **Yes**.
4. REAPER will now insert the instrument into the FX chain for the original track, name it. arm it for recording, and create all the additional tracks.
5. You now have a single MIDI input track for the VSTi together with four output audio tracks. Notice:
 - Channels 1/2 from Track 1 are directed to Track 2, Channels 3/4 to Track 3, Channels 5/6 to Track 4 and Channels 7/8 to Track 5.
 - No direct output goes from Track 1 to the Master.
3. You're now ready to load your instruments (in this example, a drum kit) and to start playing.

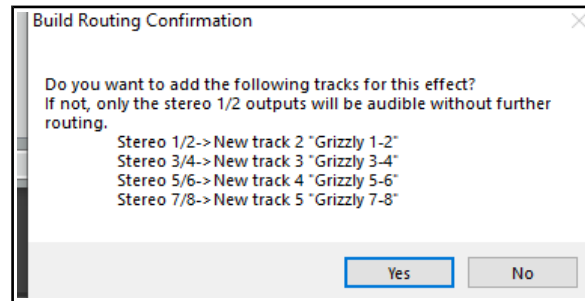

Note: Instead of steps 1 and 2, you can drag and drop the VSTi from an open FX browser window direct to the empty area of the track control panel.



Example 2: Separate MIDI Tracks

If you want a separate MIDI track for each VSTi output channel, you should use this method. Again, we'll use Grizzly, but you would use the same method for any other multi-output synth.

1. Create and name a new track. Open the track's FX window and add the VSTi to the track's FX chain.
2. From the FX window **Options** menu choose **Build 16 channels of MIDI routing to this track**.
3. You now have one MIDI track for each channel. The MIDI output of each of the 16 tracks is sent to the track on which you originally inserted the VSTi.

You have a number of options for assisting you with managing this set of tracks. For example, you can put the MIDI Tracks in one folder, name the folder, color the tracks and hide them in the Mixer. To enable keyboard input for the individual MIDI tracks:

- Make sure that the VSTi track is *not* armed for recording.
- Select all 16 MIDI tracks.
- Right-click the Record Arm button and turn Input Monitoring button on for all 16 tracks.
- For each track, set the MIDI input channel, from 1 to 16.

Automation – Envelopes and More

18 Automation – Envelopes and More

18.1 Understanding Automation

Automation is used to ensure that when your tracks are played, recorded changes in such parameters as volume level or panning can be recalled with the music in real time. At its simplest, for example, automation can lift the volume of a lead instrument during a particular break or passage, or add a little presence or warmth to the odd phrase here or there on a vocal track, to make it stand out in the mix a touch more.

A simple example of an envelope (Volume) is shown here. The envelope here is displayed below the media item. The TCP shows an envelope panel with its own controls. When the track is played, its volume will rise and fall with the shape of the envelope.

In the second example (below) the same envelope is displayed not in its own lane but on top of the media item. Both methods have their advantages and disadvantages. The first makes it

easier to work with the envelope, but uses more space. The second takes up less space, but makes editing tasks that little bit trickier. How your envelopes is initially displayed will depend on your [Editing Behavior](#), [Envelope Display Preference Settings](#). You can change the display mode of any envelope any time with the context menu **Show envelope in lane** toggle command.

REAPER features two main types of automation – one method uses *envelopes* alone, whilst the other uses a rather more complex (and powerful) technique known as *parameter modulation*. This chapter will deal with creating and using envelopes. [Parameter modulation](#) will be covered in Chapter 19.

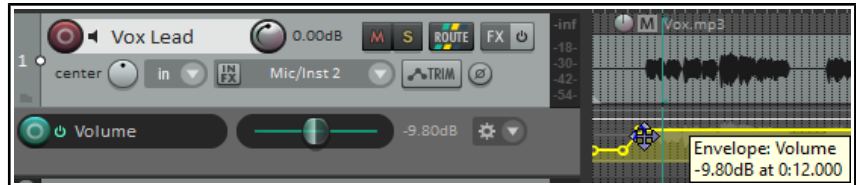

18.2 The Track Envelopes Window

Any track's envelopes can be managed from its **Envelopes Window**. This includes FX parameter and track send envelopes, The window is opened by clicking on the track's **Envelope (Trim)** button in either the TCP or MCP. Basic functions of this window include:

- Set the track's **Automation mode**.
- Create envelopes (e.g. for Volume or Pan, or for a send or an FX parameter).
- Show or hide any envelopes.
- Arm or disarm automation envelopes.

The envelopes window includes options such as showing or hiding all envelopes on the track, arming or disarming all envelopes, and automatically creating envelopes for the last touched parameter, including FX parameters. These options will be explored in the pages that follow.

The **Filter** box can help you find a parameter more easily. For example, type *pre* in this box and only items whose name includes *pre* will be displayed, i.e. Pre FX envelopes.

All plug-ins in the track's FX chain will also be listed. Shown here is a JS Stereo Enhancer.

Where FX are present on the track, the filter box above the table allows you instead of showing **All envelopes** to show only **Active envelopes** or only **Last touched FX parameters**. This helps avoid screen clutter.

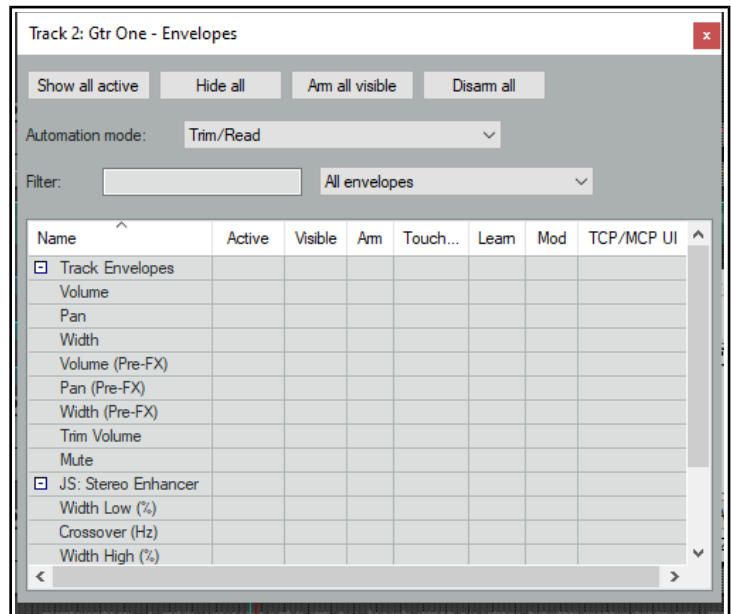

18.3 Automation Envelope Methods

REAPER's various automation modes essentially make available to you two main ways of using envelopes for automating your projects. These are writing automation and manually creating envelopes.

Trim/Read (default, faders are active for trim but not recorded)
Read (play faders with armed envelopes)
Touch (record fader movements to armed envelopes)
Latch (record fader movements after first movement)
Latch Preview (allow temporary override of armed envelopes but do not write)
Write (record fader positions to armed envelopes)

- **Writing Automation:** When writing automation, REAPER will record your actions – such as adjusting a volume control – as your project is played. An envelope is created to reproduce these during playback. The three different methods are write, touch and latch (including latch preview).
- **Manuaarrangelly Creating Envelopes:** Instead of using track control to create envelopes, shaping them manually gives you more precise control. You can draw your envelope curves freehand, add points, and use your mouse to manually move points. Trim/Read mode is used when you are creating or editing envelopes in this way. You can write envelopes in, say, latch mode then edit them in Trim/Read mode.

The active mode is displayed on a track's envelope button. We'll explore the different automation modes shortly. Different modes can be used on different tracks. All envelopes can be manually edited, or removed altogether.

18.4 Available Track and Send Envelopes

The following are the automation envelopes that by default are available for all tracks and sends. Envelopes for plug-ins and FX will be discussed later in this chapter.

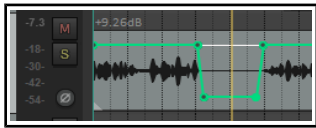
Envelope	Description
Volume	Adjusts the volume of the Track's Output, after, for example, any item or track FX have been applied. This sets the level of the signal that is sent to the Master Track.
Pan	Moves the balance pan control more towards the left, right, or dead center: the signal that is sent post FX from the track to the Master Track.
Width	Moves the width control more towards the left, right, or dead center: the signal that is sent post FX from the track to the Master Track.
Volume (Pre FX)	Adjusts the volume of the track signal that is fed to the track's FX chain. This is generally equivalent to the gain control that you can find on some desks and mixers. This works directly on the media itself: media item peak display will automatically be adjusted to match the envelope, as shown here. 
Pan (Pre FX)	Similar to Pan control but before track FX or track faders are applied.
Width (Pre FX)	Similar to Width control but before track FX or track faders are applied.
Trim Volume	A rather different type of envelope that can be used to modify the track volume envelope. This will be considered later in this chapter.
Mute	This envelope has effectively only two states – On and Off. It is used to mute passages of a track.
Send Volume	Adjusts the volume of the track signal sent to the destination track. Can be used for Post fader (Post Pan), Pre fader (Post FX) and Pre fader (Pre FX) sends.
Send Pan	Adjusts the panning of the track signal sent to the destination track. Post fader (Post Pan), Pre fader (Post FX) and Pre fader (Pre FX) sends.
Send Mute	This has only two states – On and Off. It is used to mute passages on a send.

18.5 Writing Automation

To create automation envelopes using the **Write** feature:

- In the TCP, click on the **Envelope Trim** button to open the track's envelopes window.
- This button (below) shows the current automation mode for that track.: here it is Trim.

Automation – Envelopes and More

- Select the item (a track envelope or FX parameter) that you wish to automate, and make sure to also select the options **Visible** and **Arm**.
- Set Automation mode to **Write**.
- Close the Envelopes window. The envelope button will now show **WRT**.
- Position the cursor where you wish to start.
- Play the song. As you do so, adjust the on screen control (in the envelope lane or FX window) which controls the item you are automating. Stop play when finished.
- Right click over the Envelope button for that track and from the last section of the context menu select **Trim/Read** or **Read**.
- Play the song. The automation will be applied. In **Read** mode, the parameter control will move to reflect your changes.



Many of the envelopes window's functions are also available on the Trim button's right click context menu.

Tip: The option **Automatically add envelopes when tweaking in automation write modes** (Preferences, Automation), allows you to create or modify envelopes by adjusting any control during playback.

Automation Write Example

1. Open the file **All Through The Night.RPP**. Save it as **All Through The Night AUTO.RPP**. We will add an envelope to the Bouzouki to fade it up in the passage between the first and second verses of this song.
2. Increase the height of the **Bouzouki** track, to make it easier to see what you are doing.
3. Insert the **MGA JS Limiter** plug-in to the master and to prevent clipping set its threshold to **-3.0**. Position the play cursor just before the end of the first vocal passage at about the 33 second mark.



4. Now click on the **Envelopes/Automation** button for the **Bouzouki** track. Select **Volume** and make it both **Visible** and **Armed**. Select the automation mode **Write** for this track (see above).
5. Close the Envelopes window. Notice that the Volume fader for this track is now colored red and a Volume envelope has been created. The Envelope button now reads **Write**.
6. Play the song from about the 48 sec mark for about 15 sec. At the instrumental break, use your mouse to raise the track fader for the Bouzouki volume (not the envelope volume fader) by about a three decibels. Hold it there, then at the end of the instrumental break lower the fader to its original position. Stop play.
7. Right click over the Envelope button for the Bouzouki track and choose **Automation Mode: Read** from the context menu. Zoom closely into the part of the song that goes from about 45 secs to about 65 secs.
8. The volume control is lane now green, with the automation envelope clearly visible (see below).
9. Play the song. The arrange view and mixer volume faders for this track will automatically move to show changes in volume to reflect the changes you recorded. Save this file.

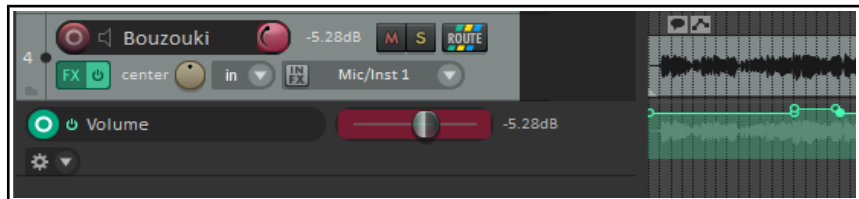

Note: You do not need to select Automation Read mode for the automation to take effect. Trim/Read mode, for example, also does this, but without moving the faders.

18.6 Envelope Points Options

The **Options, Envelope points** command helps determine envelope behavior. These are also available by right clicking on the toolbar envelope tool. **Move envelope points with media items** should be enabled if you wish an envelope to follow its media item when that item is moved or copied.

Up and Running: A REAPER User Guide v 7.31

Enabling **Razor edits affect all track envelopes** will link your envelopes with your media items when razor editing. They will be moved, copied or deleted with the media. With this disabled, you may still include envelope points/segments, etc. in your media item selections if you wish. There are some examples later in this chapter.

Be careful with **Envelope point selection follows time selection**. This will move all points within a time selection when you click/drag on any one of them. If you don't want this,, disable this option.

Edge points can make it visually easier when moving a group of points. There are options to **Add edge points when moving envelope points with items, when ripple editing or inserting time** and **when moving multiple envelope points**. You can make a time selection, choose **Select all points in time selection** from the envelope context (right-click) menu, then click and drag (left or right) any point within the selection.

There is also an option to **Preserve trailing values when recording automation**.

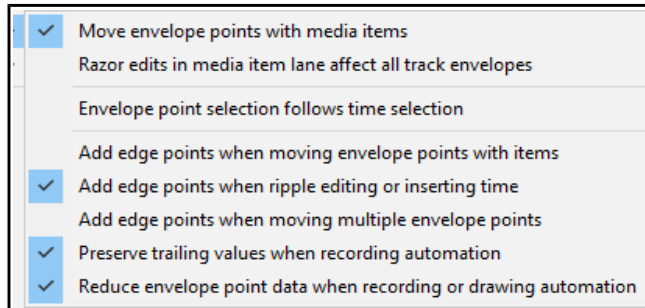

Enable **Reduce envelope point data when recording or drawing automation** if more points are being made than you want when, for example, you write automation data.

To reduce the number of points on an existing envelope that has already been recorded:

1. Select (click on) the envelope.
2. Define the required time selection.
3. Right-click over the envelope. From the menu, choose **Reduce Number of Points**.
4. Select **Points in time selection** or (possibly) **All Points**.
5. Use the fader to set the number of points. Click on **OK**.

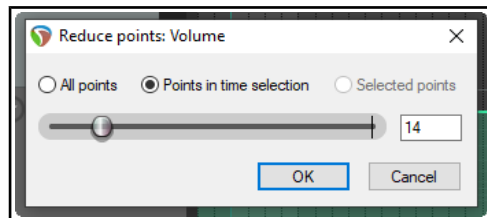

18.7 Writing Mute Automation

You can use a track's **Mute** button to automatically mute unwanted passages of a track. To do this

- Click on the track's **Envelopes/Trim** button to display the envelopes window.
- Select the **Mute** envelope and set the mode to **Write**. Then close the Envelopes window.
- The Envelopes/Automation button will read **Write** and the armed mute button will be highlighted in red.
- Notice (above) how this mode is displayed.
- Now play the track. Click on the track's Mute button at the start and end of any passages to be muted.
- When finished, stop playback. Automation mode for this track should now be set to **Read**.

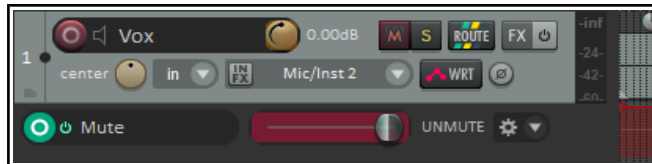

In the example (right), a vocal track is muted when it is not intended to be heard.

Read mode has been selected. During playback, the color of the Mute button changes to red during the muted passages.

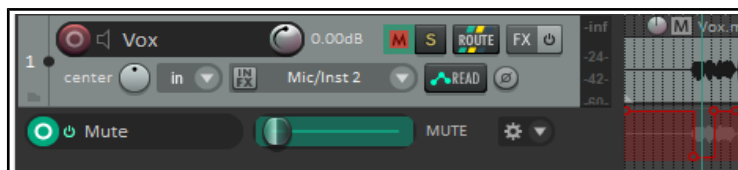

18.8 Automation Modes

Automation mode can be set as already shown from inside the Envelopes/Automation window or by right-clicking on the track envelopes/automation button. In fact, there are a number of ways that this can be done:

- Select the required mode from the Envelopes window.
- Right-click on the Envelopes/Automation button and select the required mode from the context menu.
- In the TCP, right click over any automation lane and select the required mode from the context menu.
- From the main menu, choose **Track, Track automation mode** (or right-click over the track number and select this from the context menu).

Automation – Envelopes and More

Automation Mode	Description
Trim/Read	Existing envelopes are applied, but on-screen controls do not move. Fader movements are not recorded. For example, adjusting a track's Volume fader in this mode will raise or lower the volume for the whole track relative to the envelope.
Read	Applies envelopes and moves controls for armed items, but does not write or remember any changes that you make to them.
Touch	Similar to Latch, but stops making changes to points when you stop adjusting them. If using a MIDI controller, however, Touch mode might function as Latch mode.
Latch	Writes and remembers any changes that you make to settings, and creates new points on existing track envelopes. Changes commence when you first adjust a setting, and continue to be remembered until playback stops.
Latch Preview	This mode enables you to try out changes to parameter values (e.g. volume level or pan position) without actually writing them to envelopes. When you are happy with your parameter settings you can then use an action to write them to your envelope(s). This option will be considered in a section of its own, after this section.
Write	Writes and remembers current settings as edit points, along with any changes that you make to settings for armed items during playback. <i>In this mode, previously written envelopes for armed items will be over written.</i> REAPER's Automation preferences include an option to automatically switch to another mode immediately after recording automation in Write mode. By default, it will switch to Trim/Read.

In Latch, Touch or Write mode an envelope can also be armed by clicking on the **Arm Record** button in its automation lane (where one exists). Remember also after using Write, Latch or Touch mode to change to Read or Trim/Read mode, to prevent further automation from being accidentally recorded.

A number of **actions** are available in the Actions List for smart editing existing envelopes in **latch, touch** or **write** mode. These let you copy the value of an envelope at the current cursor point all the way to the start or end of a project or to a time selection. To see a full list of these actions, enter **auto write** into the Actions List filter box. Some of these will be examined in the next section, Latch Preview Mode. Here is an example.

This track has a volume envelope, currently in trim/read mode. Note the cursor position. Suppose we want to set a later part to this same volume level.

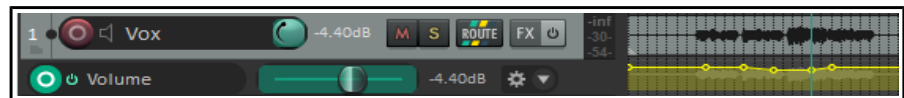

In the second picture, we have selected write mode and made as a time selection part of the envelope to change. We then, from the actions list we run the action

Automation: Write current values for all writing envelopes to time selection.

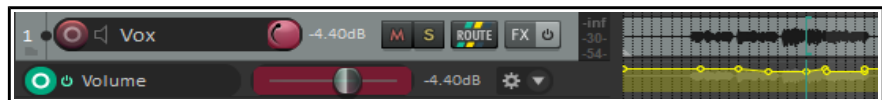

The envelope in this section is now set to the desired level.

18.9 Latch Preview Mode

This mode lets you try out changes to parameter values (e.g. volume level or pan position) without writing them to envelopes. When your parameter settings are right you can then use an action to write them to your envelope(s). Let's start by working thru a relatively simple example, before introducing some of the other options that are available.

Example



1. We want to increase the volume of the featured instrument during the break.

We have added a time selection and a volume envelope to the track

and inserted points at the start and end of the break. Automation for the bouzouki is set to latch preview mode. If the automation button is not visible this can be set from the right click context menu.

Up and Running: A REAPER User Guide v 7.31

2. We play the song, adjusting the volume control until we are happy with the level (in this case at +2.17dB).

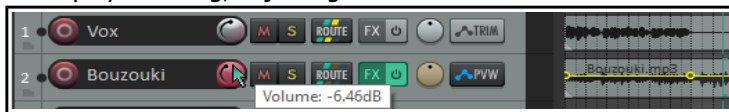

Notice, however, that the envelope has not yet been changed.

3. We now display the actions list (**Actions, Show action list**) and run **Automation: Write current values for actively-writing envelopes to time selection**.

The envelope is now adjusted (see below). Finally we can reset the track automation to trim/read mode.



You can use latch preview mode on more than one envelope on a track, and/or on more than one track. There are "write to" options other than to time selection. Here are some available actions. They can be assigned to [keyboard shortcuts](#), [toolbars](#), and/or [menus](#) (Chapter 15).

Set/Write/Clear Automation Mode Actions (see Actions List for full list)

Set automation mode actions:

Automation: Set track automation mode to ... [latch or latch preview or read or touch or trim/read or write]

Automation: Set all tracks automation mode to ... [latch or latch preview or read or touch or trim/read or write]

Global automation override: All automation in... [latch or latch preview or read or touch or trim/read or write]

Automation write actions:

Automation: write current values for actively-writing envelopes to [entire project or time selection]

Automation: write current values for actively-writing envelopes from cursor to [entire project or first touch position or start of project]

Automation: write current values for all writing envelopes [from cursor to end project or from cursor to start of project or to time selection]

Options: Preserve trailing values when recording automation.

Latch clear actions:

Automation: Clear [track or all track] envelope latches

These options together should provide you with all you need for your latch automation preview requirements.

18.10 Global Automation Override

The Global Automation Override (**Global Auto**) button on the transport bar is used to apply global options to your envelopes. Right click on this button to display a menu which can be used to:

- Toggle bypass on/off for all envelopes.
- Select a single automation mode (e.g. Trim/Read or Read) for all tracks.
- Toggle display of all active envelopes.

Global options are removed by the **No global override** command. Each track then returns to its previous automation mode. Bypass is turned off.

18.11 Envelope Panel and Track Menu Controls

The envelope panel's fader is used to write automation (write, latch or touch modes), show automation changes (read mode) or adjust the parameter value for the entire track or selected envelope segment (trim/read mode).

When a track has other envelopes that are not displayed in lanes, you can click on the envelope name (shown above is Volume) and choose from the list a different envelope to display in its place.

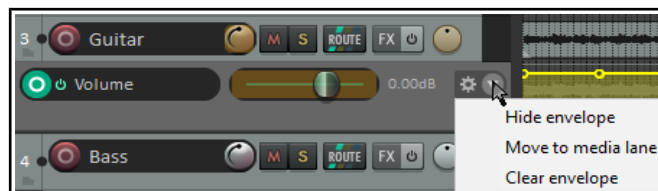

The **Track menu** includes an Envelopes command which includes toggle options for managing all **volume** and **pan**. For each of these, you can turn on or off their visibility and/or their active state.

Other controls are the **Bypass** toggle and next to that the **Hide/Clear** button (used to hide an envelope, move it to the media lane, or clear it altogether). FX parameter envelopes may also have some additional controls, for example to enable parameter modulation or learn mode (see later in this chapter and [Chapter 19](#)).

You can right-click on the envelope panel to display a context menu of envelope options, including to change the envelope displayed in that lane, remove the envelope altogether, or change track automation mode.

Automation – Envelopes and More

18.12 The Track Envelopes Window Revisited

Let's now take a more in depth look at the track envelope window, starting with the various columns.

The **plus** and **minus** buttons to the left of the category or FX name is used to display or hide the track, send or FX parameters in the parameters list.

Name lists all parameter names, including track controls, sends and/or receives and FX parameters.

Active indicates for each parameter whether an envelope already exists. Clicking in the active cell for any parameter will create an envelope. The **Visible** and **Armed** cells are used respectively to make an envelope visible and to arm it prior to writing automation in Write, Touch, Latch or Latch preview modes.

Learn sets the parameter up to be controlled by an external MIDI control device. For this to be available, you will need to have a MIDI control device enables in your MIDI preferences. This topic is explored in more detail in the subsection [FX Automation: Learn Mode](#).

Mod activates parameter modulation for this parameter. This topic is covered in detail in the next chapter.

TCP/MCP/UI adds to the track panel a control which can be used to adjust this parameters value. This control can be used when writing automation or independently of automation.

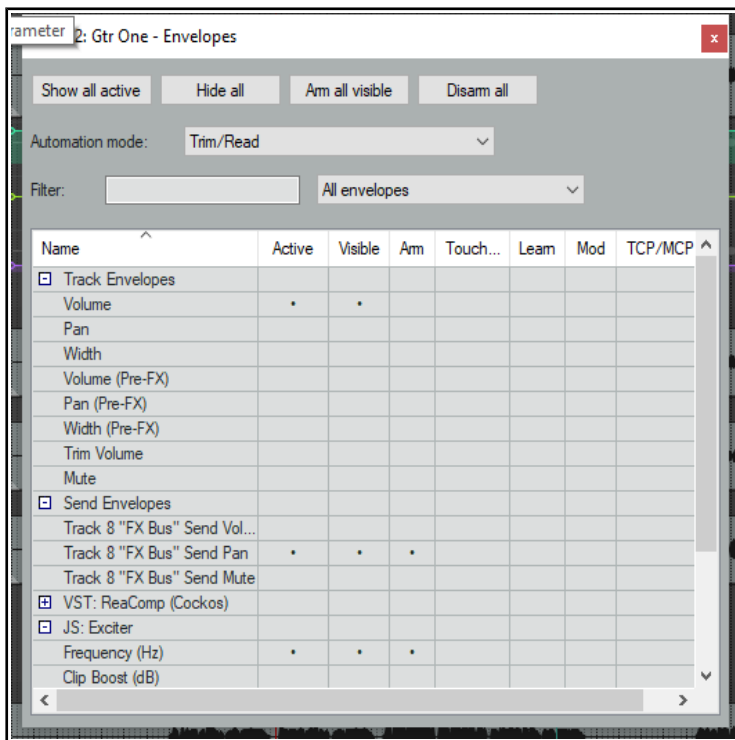

The **Show all active** button will display an envelope lane in the track panel for each envelope defined as active.

Hide all will hide all envelope panels on the track panel: **Show all active** will restore them to view.

Arm all visible will arm all visible envelopes for automation.

Disarm all will disarm all envelopes.

The **FX** button offers options to manage FX display in this window:

Expand all parameters

Collapse all parameters

Default: all FX parameters expanded

Default: all FX parameters collapsed.

In the example shown here, **ReaComp** has been collapsed and **JS: Exciter** has been expanded.

Notice also that a control for the exciter's Frequency parameter has been added to the track panel.

At the start of this chapter we introduced the Filter box. The drop down list to its right allows you to focus on only **Active**

envelopes or **Last touched parameters**, including when filtering. All other parameters and envelopes will be hidden. Choosing **All envelopes** will restore all envelopes to view.

Shown above we have three active envelopes – track **Volume**, **Send Pan** and the Exciter's **Frequency**.

Note: Right-clicking on the window's title bar will display a context menu whose options include whether or not to **Auto-close the window when focus switches away**.

18.12.1 FX Parameters: Live Real Time Automation

FX parameters can be automated directly from the Envelopes Window, without the need to open a track's entire FX chain or go delving into menus. Consider a simple example. A track FX chain might already include several FX, but for now all we want to do is to write automation envelopes for ReaEQ for the gain on bands 2 and 3.

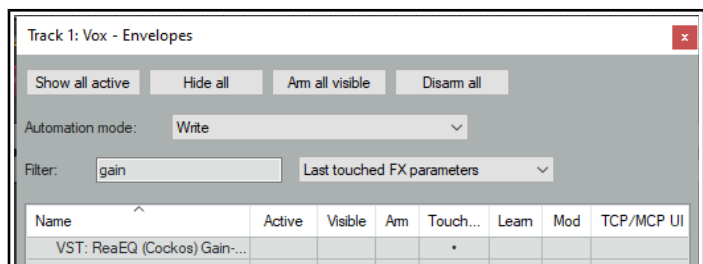

Up and Running: A REAPER User Guide v 7.31

1. We open the envelope window, type *gain* in the filter box, to check which parameters are available.
2. We set automation mode to **Write** and right-click over the text **VST:ReaEQ** and choose **Float FX** from the context menu. This opens the ReaEQ window.
3. We set automation mode to **Write** and from the drop down list select **Last touched FX parameter** (shown here).
4. Play the song, using your mouse to adjust the Gain for Band 2. After a few bars, stop playback.
5. Repeat this process, adjusting the Gain for Band 3.

The Envelope Window context menu includes options to **Expand all FX parameters** and **Collapse all FX parameters**.

Note: As you will see shortly, this and other tasks task can also be undertaken in the **Envelopes Manager**.

18.12.2 Automation with Track Sends

This example uses sends in conjunction with an FX Bus.:

1. First, create a track to serve as your FX Bus.
2. Select the track containing the media. Drag and drop from its **ROUTE** button to the FX Bus to create a send. Set send volume and pan levels as required.
3. Display the Envelopes window for the media track. Set mode to **Trim/Read**. Envelopes are available for your sends. Make sure that the **Send Envelopes** are active, visible and armed (right).
4. Close this window. An envelope lane for each send will now be visible just below track.

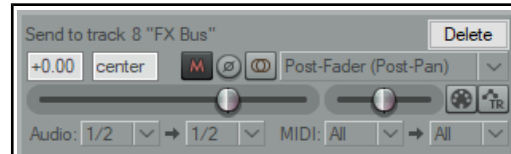

Name	Active	Visible	Arm
Track Envelopes			
Send Envelopes			
Track 8 "FX Bus" Send Volume	*	*	*
Track 8 "FX Bus" Send Pan	*	*	*
Track 8 "FX Bus" Send Mute	*	*	*

You can now adjust these envelopes as required. See also the section [Automation with hardware sends](#).

18.13 The Envelope Manager

The Envelope Manager includes all the features of the Track Envelope Window, with the added benefit of letting you manage automation from a single interface across your entire project rather than only for the one track. This also includes managing item take and FX envelopes. There are two ways of opening the Envelope Manager:

Either: Choose **View, Envelope Manager** from REAPER's main menu,

Or: Hold **Shift** while clicking on the automations (Trim) button of any track in a track selection.

The Envelope Manager includes an extra drop-down, **Context** (see right). If you have opened it by shift clicking a track's automation button then this menu will include options to select and work on that track only or on all selected tracks (as shown here). Shift clicking on the TCP automation button of another track within the selection will make that track the selected track. If opened from the View menu, the Envelope Manager menu will include no option to work on a named track.

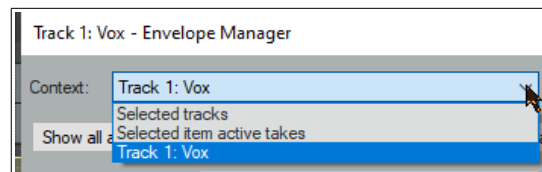

18.13.1 The Envelope Manager Basics

Please read this carefully! It gets a bit tricky in places. It might take some time to understand it.

- ◆ You can select one track or multiple tracks, as you wish, before opening the Envelope Manager. Use **Ctrl click** to build a multiple track selection. After opening the Envelope Manager you can also use **Ctrl click** to add tracks to or remove them from an existing track selection.
- ◆ If you have only one track selected when opening the manager, then, as long as that remains the only track selected, the first and last options on the menu are effectively the same. the Envelope Manager will then behave in the same way as the track envelope window.
- ◆ If from the Context dropdown you select a named track, then any options you select will be applied only to that track. In the example shown above, this would be **Track 1: Vox**.
- ◆ If you have multiple tracks selected with the **Selected tracks** option enabled, then your options will be applied to all tracks in the selection. For example, if you have three tracks selected and make Volume and Pan active and visible then Volume and Pan envelopes, active and visible, will be added to all three tracks.
- ◆ To add automation to a track from within the Envelope Manager, select only that one track before adding or writing the automation envelope.

Automation – Envelopes and More

- ◆ With the **Selected tracks** option, only those parameters present in all of the selected tracks will be shown. For example, if all tracks in the selection contain ReaEQ – and only if they all do - then ReaEQ will be shown in the Envelope Manager. You can then use the Envelope Manager to add, say, a band gain envelope to all tracks in the selection. Adjustments to individual envelopes can then be made in Arrange View.

18.13.2 Item FX and Take Envelopes

The **Selected item active takes** option from the **Context** drop down menu allows you to manage **item FX and take envelopes**.

Select the required item or take in Arrange View. You can apply a filter (as here) and select either **All envelopes** or **Active envelopes**. As in the track envelope window, you can also select a required automation mode and float the FX window if you wish (to control the FX from there).

Working with item FX and take FX envelopes is essentially the same as in the Track Envelopes Window except that the Envelope Manager will indicate (in the Touched column) any last touched FX parameter. This can also be used to mark an FX parameter as touched without needing to use the FX GUI.

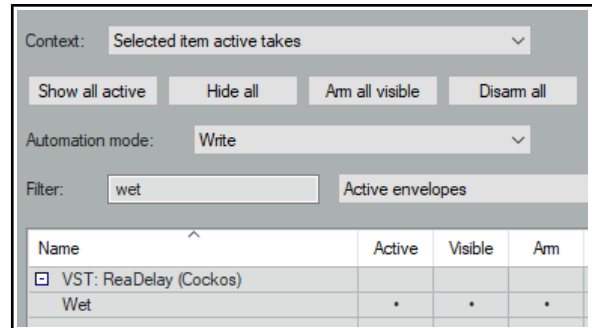

18.14 Manually Editing Envelopes

As an alternative to writing automation you can use your mouse directly within the envelope lane. For example, you might see from observing the waveform that there is a peak that needs adjusting. Suitable actions include:

- **Shift Click** for adding points to an envelope.
- **Ctrl Click Drag** for freehand drawing of points and curves.
- **Click Drag** for moving envelope segments freely up or down or envelope points in any direction.

These can be changed in your **Mouse Modifier** (Envelope segment) preferences if you wish. In this example, we will assume that **Click Drag** is used to adjust segments, and **Shift Click** to add points.

The example that follows uses the mouse to raise the volume of an envelope a little for the duration of the short instrumental break that occurs between the second and third verses. You will then draw an automation over part of a track. This example assumes that the default mouse editing behavior settings are as shown above.

Example

1. Hover your mouse over the envelope, just before the start of the second instrumental break. This will be at or near 1 min 36 seconds. The mouse will change to a vertical double-headed black arrow.
2. Holding **Shift** click the mouse on the envelope to create a point.
3. Repeat this three times as shown, to add two points just before the break and two points just after it.
4. Hover the mouse anywhere between the second and third point. Click /drag upwards to raise the volume of this envelope a little, as shown (right) Save this file.
5. Display the track's Envelope Window. Set the track's automation mode to **Read**, select the **Volume** envelope and set it to **Visible** and **Arm**.
6. Play the song. The Bouzouki volume will now be faded up for both instrumental passages and then down after them.
7. Select the **Vox** track. Press **V** to display its Volume envelope. Zoom to the passage from about 1 min 0 sec to 1 min 19 secs. We can make this passage a little louder.
8. Hover the mouse over the envelope at 1:00. Hold down **Ctrl** and drag the mouse pencil along to about the 1:19 mark (right) then release it. This will draw changes to the volume envelope.
9. Any excessive points can be removed using the **Reduce number of points** command.

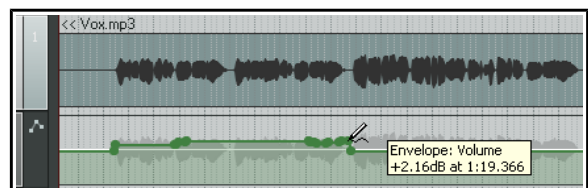
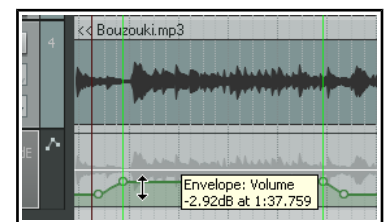
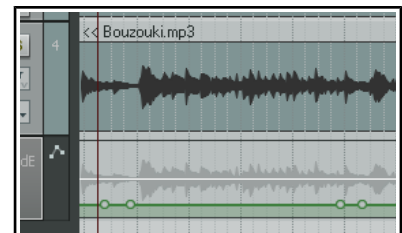

Envelope Editing Actions

REAPER's Actions List includes several actions that can be useful when editing envelopes. These include:

- | | |
|---|--|
| Add/edit envelope point value at cursor | Insert 4 envelope points at time selection |
| Insert new point at current position | Delete all selected points |
| Delete all points in time selection | Invert selected points |
| Select all points | Unselect (clear selection of) all points |

Browse the Actions List to investigate what other actions are available!

Amplitude vs Fader Scaling: Right-click over a volume envelope for a context menu which includes **Volume envelope scaling** (under the **Envelope defaults** option). Options are amplitude scaling (the default) and fader scaling. With amplitude scaling, half as high, for example, is half as loud, whereas with fader scaling the envelope height corresponds to the track fader. Fader scaling makes editing envelopes at low volume easier. Changing your preference on an envelope with existing points will affect the volume produced by that envelope.

You can change the default setting from amplitude scaling to volume fader scaling on the **Options, Preferences, Project, Track/Send Defaults** page. You should also familiarise yourself with the various options under **Preferences, Editing Behavior, Envelope Display** (see Chapter 22)

18.15 Using the Mouse with Envelopes

The above exercise has introduced you to some examples, but there are many other techniques and mouse tricks that can be used for manipulating and managing envelopes and their nodes. This table is a summary of the most important. For a fully comprehensive list, consult the Mouse Modifiers page of your Preferences.

In order to do thisyou need to do this
Select all points on envelope inside time selection.	Click and drag in envelope lane (not on envelope itself) to create time selection.
Draw and shape envelope in freehand mode.	Ctrl Drag anywhere on, above or below the envelope
Add a point.	Shift Click on envelope.
Delete envelope point.	Alt Click on any envelope point.
Select multiple envelope points.	Hold Ctrl and click on envelope points one at a time.
Select all points in an envelope.	Click on any point in an envelope, then press Ctrl A .
Select all points within the lasso area.	Click on a point, then use right-click-drag to lasso (marquee) a portion of an envelope. Release mouse.
Apply an envelope command to a selection of points.	When you have several points selected, right click over any selected point.
Move a point or selection of points freely.	Click and drag any point in the selection.
Finely adjust a point's vertical position.	Ctrl Alt Drag on any envelope point.
Allow an envelope point to be moved vertically or horizontally only.	Click and hold mouse on any envelope point, hold both the Ctrl and Shift keys while then dragging any envelope point either vertically or horizontally.
Reset point to center (default value).	Double-click on envelope point.

Most of these defaults can be changed in your **Editing Behavior, Mouse Modifiers** preferences settings.

18.16 Managing Automation Envelope Display

REAPER offers you a flexible range of options to determine how you display your automation envelopes. For any track or track you can choose to:

- Display all automation envelopes in separate lanes, or
- Display all automation envelopes over the media items, or
- Display some envelopes in lanes and others over the media items, or
- Display some envelopes and hide others, or
- Hide all automation envelopes.

Automation – Envelopes and More

In the example shown here, a track is displaying three envelopes. – one each for Pan, Track Volume and the volume of a send to an FX bus. One of these – Pan – is displayed on top of the actual media item. The other two each have their own lanes. The



[Peaks/Waveforms preferences](#) option to **Draw faint peaks in automation envelope lanes** has been enabled. The summary table explains how you use these options.

You should also set the preference ([Editing Behavior, Automation](#)) **When adding volume/pan envelopes, apply trim to envelope and reset trim to Always**. Your safest option is to set this to **Never** to ensure that the envelope will be placed in the vertical center of the automation lane, thus leaving adequate room both above and below the envelope for manual editing.

In order to do this you need to do this
Hide an individual envelope	Right click over the envelope and choose Hide Envelope from the menu, or, in the envelope panel, click on the Hide/Clear button and choose Hide Envelope .
Display a currently hidden envelope	Click on the Envelopes/Automation button in the TCP and check the Visible box for that envelope.
Change the envelope displayed in a particular lane	In the TCP, right click over the envelope name and choose another parameter from the list.
Move an envelope from its own lane to over the media item(s)	Right click over the envelope and disable the Show envelope in lane option, or click on the Hide/Clear button in the envelope panel and choose Move to media lane .
Move an envelope from over the media item to its own lane	Right click over the envelope and enable the Show envelope in lane option
Show all visible envelopes in individual lanes	In the TCP, choose Show all visible track envelopes in envelope lanes from envelope button's right-click menu.
Show all visible envelopes over their media item(s)	In the TCP, choose Show all visible track envelopes in media lane from the envelope button's right-click menu.
Show all active envelopes	In the TCP, right click over the envelope button and choose Show all active track envelopes , or open the Envelopes/Automation window and click on Show all active .
Hide all envelopes	In the TCP, right click over the envelope button and choose Hide all track envelopes , or open the Envelopes/Automation window and click on Hide all .

18.17 Envelope Shapes

Envelopes can be any of six shapes – **Linear**, **Square**, **Slow Start/End**, **Fast Start**, **Fast End** or **Bezier**. To change the shape of an existing curve, right click over the envelope point, then choose **Set Point Shape**, then the required shape from the menu. The examples below illustrate the different shapes:

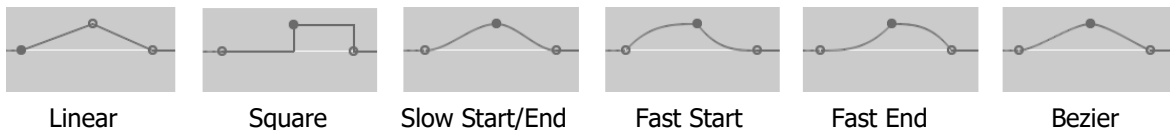

Shapes other than square are usually best used for graduated parameters, such as volume and pan. Not all shapes are available for all parameters. For example, for those with only on/off status (such as bypass and mute) the only shape available is square. This principle applies to track, FX and [MIDI CC](#) envelopes.

You can specify your preferred default envelope point shape type from the [Options, Preferences, Project, Track/Send Defaults](#) window.

Envelopes in Track Templates: If you save a track (or selection of tracks) as a track template (**Track, Save tracks as track template** command) there is an option in the dialog box to **Include envelopes in template**.

18.18 Envelope Edit Mouse Modifiers

After working with envelopes for a while you might wish to consider changing some of the default mouse modifier settings to suit your personal workflow. There are several contexts relevant here – **Envelope lane** (left drag and double-click), **Envelope segment** (left drag and double-click), and **Envelope point** (left drag and double-click).

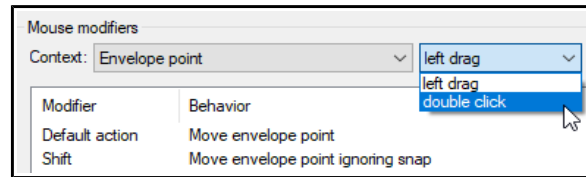

Some examples of default behaviors are listed below: see also [Options, Preferences, Mouse Modifiers](#)

Envelope point left drag

Left drag	Move envelope point
Shift left drag	Move point ignoring snap
Ctrl left drag	Freehand draw ignoring snap
Shift Ctrl left drag	Move point on one axis only
Alt left drag	Delete envelope point
Ctrl Alt left drag	Move envelope point vertically

Envelope point double click

Double click	Reset point to default value
Ctrl double click	Open envelope point editor.

Envelope segment double click

Alt double click	Reset segment curvature
------------------	-------------------------

Envelope segment left drag

Left drag	Move ignoring time selection
Shift left drag	Insert envelope point
Ctrl left drag	Freehand draw ignoring snapping
Shift ctrl left drag	Move envelope segment
(up/down)	
Alt left drag	Edit envelope segment curvature
Shift alt left drag	Move preserving edge points
Ctrl alt left drag	Move envelope segment (fine)

Envelope lane left drag

Shift left drag	Insert envelope point
Ctrl left drag	Freehand draw ignoring snap

Any of these default behaviors can be changed in the Preferences, Mouse Modifiers window.

For example, if you manually add points to envelopes a lot you might wish to change the default behavior for Envelope double-click from *Reset point to default value* to *Envelope: Insert new point at current position*. You might wish to set *Move envelope point horizontally* as one of your envelope point modifier instead of just *Move envelope point*.

Also, by default, double-clicking on an envelope's control panel will select all points on the envelope.

18.19 The Envelope Panel Controls

An envelope displayed in a lane can have its behavior and characteristics modified from within the TCP, using its fader, its buttons and its context menu. For example:

- In **Trim/Read** mode, use the knob to raise or lower envelope for its entire length or for a particular time selection. For example, with no time selection active, adjusting a pan envelope's control knob to the left (anti-clockwise) would cause panning for the entire track to be moved further to the left (maintaining the relative movement between existing points). If a time selection is active, then the envelope would be adjusted only within that time selection.
- Use the **BP** button to toggle bypass on and off.

Right clicking over the envelopes **Trim** button in the TCP produces a menu which includes the following:

- A list of all available envelopes (track and send parameters plus any FX parameters). Choose one of these to change the envelope displayed in this lane.
- Various show/hide/remove envelope options.
- A list of automation modes: this is one way to change a track's automation mode.

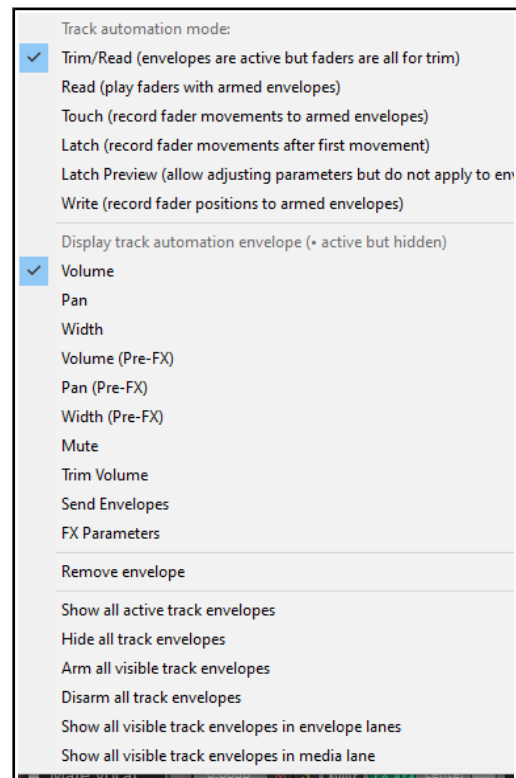

Automation – Envelopes and More

18.20 Managing and Manipulating Envelopes

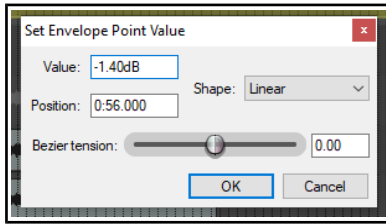

The Envelope Point and Envelope Segment right-click context menus both contain commands and options that are there to help you manage and manipulate your envelopes. Which of these two menus will appear depends on whether your mouse is hovering over an actual point or over a segment when the right button is clicked.

In the table below, those commands which are on the Envelope Point menu only are indicated by **(P)**.

Command	Explanation
Envelope defaults, Default point shape	Sets default shape for new envelopes. Choose from Linear, Square, Slow start/end, Fast start, Fast end, Square and Bezier (see also next section).
Set point value ... (P)	Displays the Set Envelope Point Value dialog box. Can be used to change the value, position, and/or shape of the current point. The units used for position are determined by your ruler settings. Optionally, you can assign Double Click (under Preferences, Mouse Modifiers, Envelope Point) to Open envelope point editor .
Set point shape (P)	Changes the shape of the current point. The six available shapes are Linear, Square, Smooth, Fast Start, Fast End and Bezier. See next section.
Set shape for selected points	Allows you to choose a shape for multiple envelope points. The six available shapes are Linear, Square, Smooth, Fast Start, Fast End and Bezier.
Select all points	Selects all points in current envelope.
Unselect all points	Unselects all points in current envelope.
Select all points in time selection	If a time selection is currently active, all points on this envelope that fall within the time selection will be selected.
Copy points	Copies all points in current selection into clipboard. Note: To apply a command to an existing selection of envelope points, you should hold Shift while you right click over the envelope. This ensures that the selected points remain selected when the context menu is displayed.
Cut points	Cuts all points in current selection into clipboard.
Delete point (P)	Deletes the envelope point.
Delete selected points	Deletes all envelope points in current selection.
Move selection of points	Use NumPad 4 (left) or NumPad 6 (right).
Delete points in time selection	All points that fall within the current time selection will be deleted. Shown here is a selection of points before and after using this command. 
Double click on fader in envelope panel to insert 4 points at time selection	Inserts two points at start and two points at end of time selection: allows you then to easily move that envelope segment up or down.
Invert selected points	Causes all selected points to be inverted relative to their neutral position. For example, a point on a Pan envelope set at 50% left would be changed to 50% right. When items such as Volume use a logarithmic scale, the calculation is less obvious.

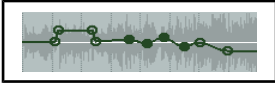
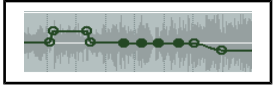
Command	Explanation
Reset select points to zero/center	Sets all selected points back to a neutral position. Shown here is a selection of points before and after using this command. <div style="display: flex; justify-content: space-around; align-items: center;">   </div>
Reduce number of points ...	Reduces the number of envelope points within a time selection or for the whole envelope. This has already been explained in detail.
Arm envelope for recording	Toggles armed status of envelope on and off.
Show envelope in lane	Toggles the envelope into or out from its own envelope lane.
Hide envelope	Hides the envelope but keeps it active.
Bypass envelope	Toggles an envelope's bypass status.
Clear or remove envelope ...	Clears all points on an envelope, restores it to a straight horizontal line. You will be asked if you wish also to remove the envelope.
Copy an envelope from one track to another	Select all points on source envelope, press Ctrl C . Add empty envelope to target track. Select target envelope, position cursor, press Ctrl V .

18.21 Envelope Preferences

REAPER's envelopes preferences fall into several different categories within your **Options, Preferences** window. These are explained in more detail in Chapter 22. Meanwhile, it's worth taking note of the following.

The **Appearance** pages of your **Options, Preferences** window includes a number of useful options for determining how your envelopes are presented on screen. In particular, pay attention to the options to:

- **Show solid edge on time selection highlight** (Appearance page). Makes the boundaries of the time selection more obvious.
- **Show guide lines when editing** (Appearance page). Facilitates editing.
- **Draw faint peaks in automation lanes** (Peaks/Waveforms page). Can help to relate an envelope's position to the track's volume level.
- **Fill automation envelopes** (Appearance page): this faintly colors the area below the envelope.

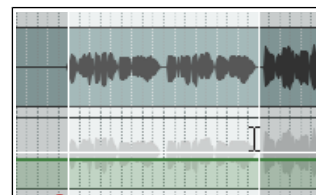

The **Editing Behavior, Automation** page (see Chapter 22) includes important options. It gives you the option, for example, to **Automatically add envelopes when tweaking parameters in automation write mode**. This enables you to create envelopes on the fly without having to select the required parameters from any menu.

Some of the options on the **Project, Track/Send Defaults** are also relevant to envelopes. These include:

- Whether to have any envelopes (such as Pan and Volume) automatically displayed for all new tracks.
- Your choice of default envelope shape for new points.
- Your choice of default automation mode for new tracks.
- Whether new envelopes are to be automatically armed.

18.22 Using an Envelopes Toolbar

Chapter 15 explains in detail how to [create custom toolbars](#). If you work a lot with envelopes then this is one area where you can achieve real productivity benefits.

18.23 Moving and Copying Envelopes with Items

You can choose whether or not to move and copy automation envelopes with media items by setting the option to **Move envelope points with media items** on or off. This is accessed by right clicking on the Envelope tool on the main REAPER toolbar, or by choosing **Envelope points** from REAPER's Options menu. In the Actions editor you can assign a shortcut key to toggle this action on and off.

- If this option is turned off, then envelopes will *not* be moved or copied with the media items.

Automation – Envelopes and More

- If this option is turned on, then the envelopes *will* be moved or copied with the media items.

An example of this is shown here. A selected portion of the media item on the top track is being copied to the track below it using the **Ctrl** drag and drop method.

You can also specify options for **Add edge points** (at the start and end of the time selection) when moving envelope points with items, ripple editing or inserting time, and/or moving multiple envelope points. In the example shown (right), not only is the envelope copied with the media item, but also the option to show guidelines has been selected.

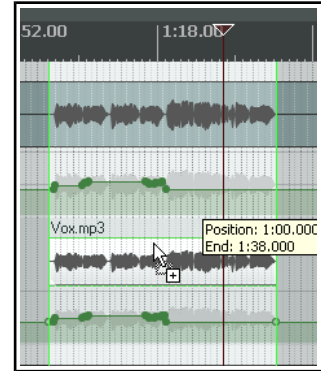

18.24 Copying Points From One Envelope to Another

To copy a single point from one envelope to another (or to another location on the same envelope):

- Select the point and press **Ctrl C**.
- Select the timeline position on the destination envelope, press **Ctrl V**.

For more sophisticated tasks such as copying a range of points from one envelope to another you will need to use the [Actions List](#) (Chapter 15). This example uses the action **Envelope - Copy points within time selection**. You can assign a keyboard shortcut to this action if you wish.

To copy a range of points from one envelope to the other, or to a different position on the same envelope:

- Make the time selection containing the points and select the envelope. Run the action **Envelope - Copy points within time selection**.
- Select the required position along the timeline in the destination envelope and press **Ctrl V**.

18.25 Automation with Trim Volume Envelopes

Note: The illustrations in this section use the REAPER 5 default theme. The method and instructions are the same regardless of which theme you are using.

The Trim Volume is a special kind of envelope that can be used to fine tune or “tweak” a track’s volume envelope. This might be the case, for example, if you wish to experiment with different volume levels before committing them to the volume envelope. Some points to note about trim envelopes are:

- It does not correspond to any track control and cannot be armed or written in write, touch or latch mode.
- While it is possible to use a trim envelope on its own, i.e. without also having a volume envelope, this practice is not generally recommended.

Here is an illustration of how Trim Volume might be used:

Example

In this first illustration, (above right) a volume envelope has been added to lower the vox during part of the song. On playback, however, we might find that the occasional phrase or word might be slightly buried in the mix.

A trim envelope is added to further adjust the volume of this track (as shown). You can take this one step further and lock the trim changes on to the volume envelope.

REAPER includes the following two actions:

- Track: Apply trim envelope to volume envelope,**
- clear trim envelope,** and
- Track: Apply volume envelope to trim envelope,**
- clear volume envelope.**

In the above example, you could run the first of these actions to produce the result shown. The trim envelope could then either be removed altogether, or used to again make further changes to the volume envelope.

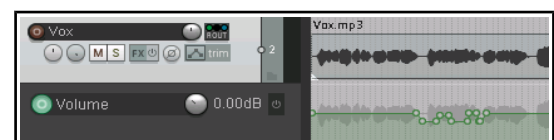
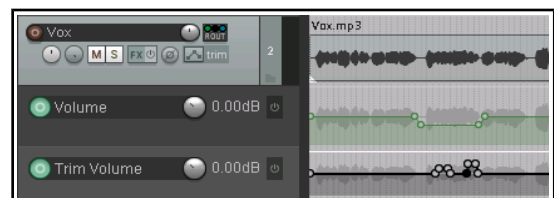
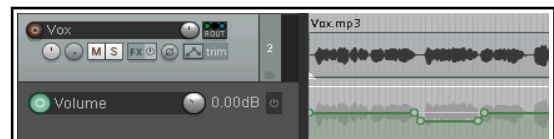

18.26 Locking Envelopes

Envelopes can be locked in order to prevent any accidental changes or deletions from taking place.

Pressing **Shift L** (or right-clicking on the Lock toolbar button) will cause the **Lock Settings** window to be displayed (see right).

You should then select the **Take envelopes** and/or **Track envelopes** options, along with any other aspects that you also require to be locked. You can reverse these settings at any time.

Note that even with your envelopes options selected, locking will only be applied if you also select the **Enable locking** option. The keyboard shortcut **L** can be used to toggle lock enabled status on and off.

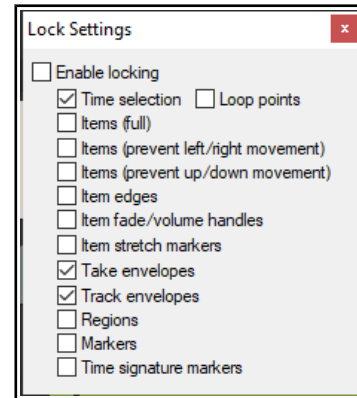

18.27 Automation with Grouped Track Parameters

If you have created **track groupings** in which you have defined relationships between various parameters, you can ensure that those relationships are maintained (or not, as you wish) when automation envelopes are being written. This is done using the group **Automation Mode** column on the Track **Grouping Matrix**.

As when the track parameters themselves are grouped, the automation mode status for each track in the group can be set to lead, follow, or both lead and follow. Here are examples. In each case, the grouping is similar to that used in the exercise file **All Through The Night GROUPS.RPP**. If you completed those examples it might help you to open that file now.

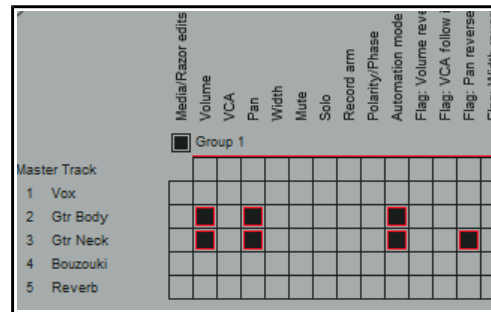

Example

Both guitar tracks are set to act as both lead and follow in automation mode. The flag pan reverse is enabled. Both pan envelopes are armed (indicated by the colored circular button on the pan controls).

Set either track to write (as shown), touch or latch mode and the other will change with it. Any automation movements will then be written to both tracks.



18.28 Automation of FX Parameters

You have already seen how FX parameter envelopes can be created from the Track Envelope Window or Envelope Manager. They can also be created from inside the plug-in's own window.

1. Click your mouse on the required parameter.
2. Click on the **Param** button then choose **Show track envelope** from the menu.

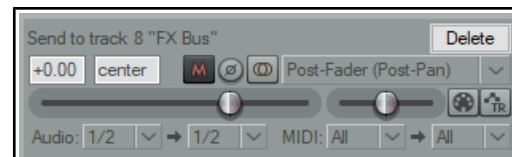

Most FX can be automated in this way, but with some older plug-ins this might not be possible.

18.29 Automation of Container FX Parameters

In **Chapter 17** we introduced and explained the use of FX containers. By default, these FX parameters are not listed in the track's envelope window. To create an envelope for any such parameter do this:

Click your mouse first on the control (such as a fader) that you wish to automate, then on the FX **Param** button.

From the Param menu choose **Map to container parameter**. If you wish, also choose **Show in track controls**.

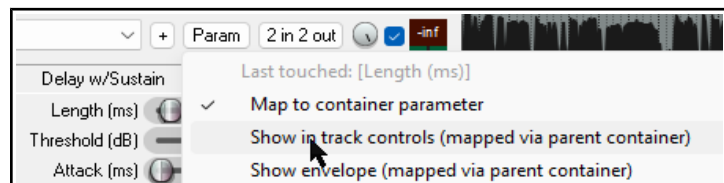

An envelope for this parameter will now be available in the track's envelope window, from where it can be managed (made active, visible, armed, etc), just like your other FX parameters.

Automation – Envelopes and More

18.30 FX Automation: Learn Mode

A MIDI controller or control surface can be used in write, latch or touch mode to create FX parameter envelopes:

1. Within the plug-in window, click on the parameter, then on **Param** then on **Learn**. Tweak the button, knob, or fader on the control device. A confirmation message appears in the Command field.
2. Select a CC mode: usually this will be absolute or one of the relative options. Consult the device's documentation: if in doubt, try **Absolute** to begin with. For smoother operation, choose **Soft takeover**. Toggle mode is also available: this allows FX parameters to be toggled on/off with a single mapping. Optionally, select **Enable only when effect configuration is focussed**. This allows you to assign the same control to another parameter in a different plug-in.
3. When the **MIDI/OSC Learn** dialog box is shown, tweak the control on the external device, select the option **Arm envelope for selected parameter** and click on **OK**. The envelope will be displayed.

You can use the control device to write changes to the envelope during project playback (see section 18.5). In Trim/Read mode you can use the control device to manually adjust the parameter.

18.31 Automating a VST with MIDI CC Messages

Depending on what gear you have, there are two other further methods you can possibly use to send MIDI CC messages to automate a VST's parameters:

1. Send MIDI CC from a MIDI source (such as a MIDI keyboard controller, a MIDI track, ReaControlMIDI, or an FX which outputs MIDI CC messages) directly to the VST. In some VSTs MIDI CC messages are hard-wired to specific controls (e.g. LinPlug's Alpha), in others (e.g. Kontakt) the mapping is assignable.
2. Send MIDI CC from a MIDI source to **MIDItoReaControlPath (S&M)**. This injects the MIDI CC messages into the Reaper automation path and onwards to a track VST Parameter Envelope for which MIDI Learn has been used to map the CC message to that envelope. To learn more about (and download) this plug-in, go to forum.cockos.com/showthread.php?t=43741.

18.32 Automating FX Parameters on the Fly

If you turn on the Editing Behavior, Automation preferences option to **Automatically add and arm envelopes when tweaking parameters in automation write modes**, then for any track set to write, latch or touch an automation envelope will be created for you as you tweak the parameter settings during playback.

This feature can be used in conjunction with a control surface. Be careful, though, or you could end up creating a whole heap of unwanted envelopes!

Note: When you finish recording automation envelopes in this way, change Automation mode to Read or Trim/Read, otherwise every parameter you tweak will create another envelope, whether you want it to or not.

18.33 Automation with Item Take and Take FX Parameters

Individual media items and takes can be given their own **Volume, Pan, Pitch** and **Mute** envelopes. Right click over the item, choose the **Take** command, and then select your required envelope from the menu. Alternatively, you can click on the item's envelope button (if visible) and make your selection from there. Item buttons can be selected to be displayed from the **Appearance, Media** page of your Preferences window.

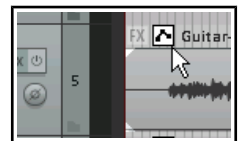

Envelopes with Media Items

In the example (right), a pan envelope is added using the **Take, Take pan envelope** command. It is panned first away from the center and back again.

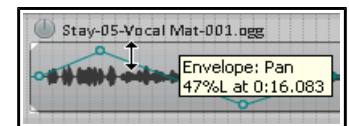

The envelope can be edited (points added, moved, and so on) like any other. Right-click over any envelope point or segment for the context menus. You can have different envelopes for different takes of the same item.

Envelopes with Multiple Takes

In the third example shown, pan envelopes have been added to the each take for the last verse of a song, with different FX. The use of different panning and the touch of ReaVerbate added to one of the takes can make for an interesting vocal effect when the **Play all takes** option (media item properties) is enabled for this item.



Up and Running: A REAPER User Guide v 7.31

To copy item take envelopes from one item to another on the same track, use **Ctrl drag** from envelopes button to envelopes button. To move envelopes, use **Alt drag**. Display of these buttons can be enabled on the Appearance, Media page of your Preferences window.

Tip 1: To automatically create an envelope for any FX parameter adjusted on the fly during playback, enable the **Preferences, Editing behavior, Automation** option **Automatically add envelopes when tweaking parameters in automation write modes**, then set track automation mode to touch, latch or write.

Tip 2: If you use **Ctrl Shift Drag** to copy an FX from one track or item to another, then any and all FX parameter envelopes associated with that FX will be copied with it.

Envelopes with Per Take FX Parameters

Parameters on FX that have been added to individual takes can also be automated. These can be edited manually, with points being added by hand in trim/read mode, or recorded in write, latch or touch mode. The procedures for manually editing or write/recording item/take FX parameter envelopes is essentially the same as those used with track FX parameters. Parameters can be selected for automation in either of two ways:

- From the media item's Envelopes for takes window. To display this, click on the automation envelopes button (if visible), or you can choose **Take, Take envelopes...** from the take's right-click menu, *or*
- Display the track's FX chain (**Shift E**), select the required FX, then select the required parameter envelope from the **Param** button menu. Note that **Learn** mode is also supported.

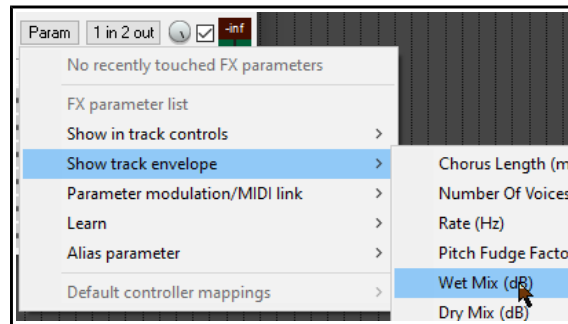

Tip 1: Any FX chain can be copied from one media item to another by dragging and dropping the FX from the first item's FX chain to the second item. Drag and drop the item FX button itself to copy the entire chain.

Tip 2: Envelopes can then be copied between media items by dragging and dropping the envelopes button.

Tip 3: The action **Envelopes: View envelopes for last touched track/item** will open the track's or item's envelopes window. You can then add or remove envelopes to or from that track or item

18.34 Automation with Hardware Output Sends

If using hardware output sends with any of your tracks you will find that you can automate the Volume, Pan and Mute parameters for these sends. These items will appear in the track's envelopes window as shown on the right.

In the example shown, we have a send from Track 1 to an Audio Hardware Output. We can now control the send volume with an envelope.

We can even go one better. We can use fader movements to shape this envelope, but without using Write mode for any other envelopes that we may also have created. This can be done from within the track's routing window.

In the screen shot below automation mode has been set to Touch from within the routing window, just for that one envelope. You could now play your track, adjusting the audio hardware output send fader in the window shown below to adjust the send volume level and create your envelope. You can also do this with Track Send envelopes.

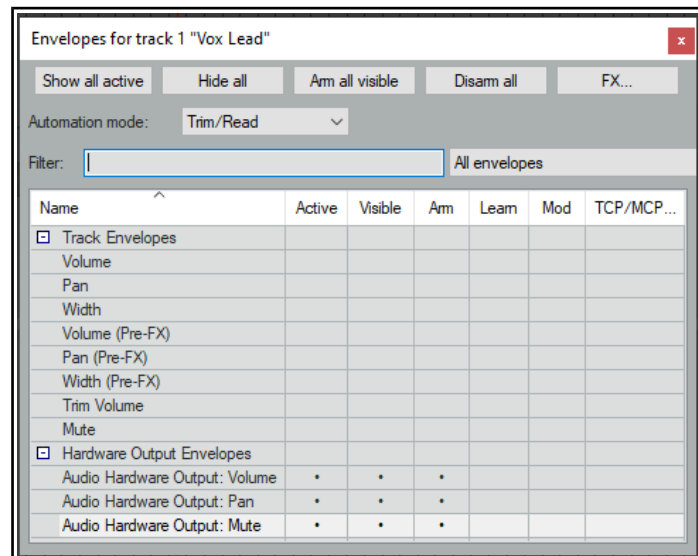

Automation – Envelopes and More

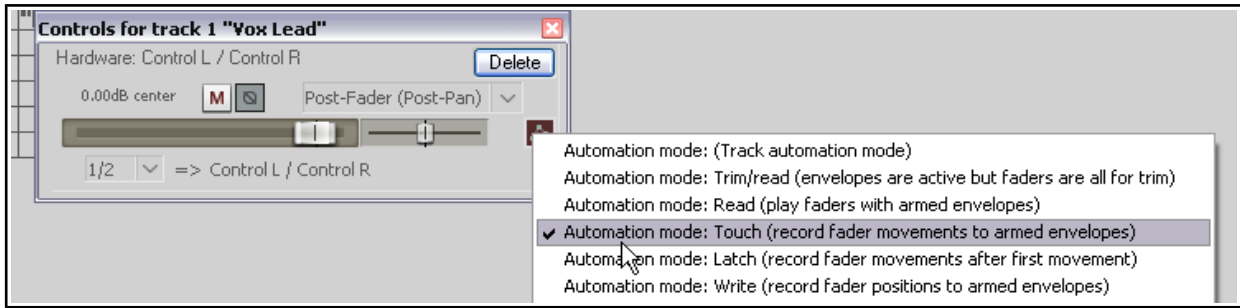

18.35 Automating the Metronome

Metronome behavior can be automated – e.g., to play only at the exact times that you require. To do this, create a new track and use the command **Insert, Click Source** to insert a media item into your file. Treat this click track like any other track – for example, add a mute envelope to mute certain passages, and so on.

To modify any click track properties, right click over the track and choose **Source Properties** from the menu. For example, you can change the BPM setting, or use your own sample files to create the beats.

18.36 Tempo/Time Signature and Play Speed Envelopes

In Chapter 10, you learnt how to [change time signature and/or tempo within a project](#). Another (and perhaps more intuitive) way of doing this is to use the Tempo/Time Signature Envelope. To display this envelope in the main REAPER arrange window:

1. From REAPER's main menu choose **View, Tempo envelope**. This displays the Master and its tempo envelope in arrange view.
2. Set the Automation mode for the Master Track to **Read**.

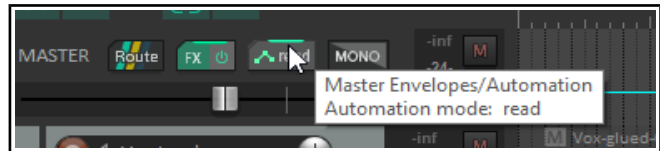

With the tempo map visible an envelope appears on the Master Track in arrange view. The default envelope range (bpm) is set in your [Editing Behavior, Envelope Display](#) Preferences (Chapter 22). You can vary this range for individual projects: right click over the envelope and from the menu choose **Envelope defaults, Tempo envelope range** to open a dialog where you can do this.

To select your preferred point shape, right click on the envelope and from the context menu choose **Envelope defaults, Default point shapes**, then either **Linear** or **Square**.

This envelope can be modified: you can add points (**Shift click**), or draw freehand (**Ctrl drag**), move them, delete them, adjust them, etc. The master tempo envelope cannot be modified by freehand drawing. Editing multiple points at once on this envelope causes each point to be adjusted *pro rata*, not by a constant BPM value.

With each envelope point a tempo/time signature marker is added on the timeline - editing their values has the same effect as editing the envelope points. If you move them, the points move with them (and vice versa). REAPER's [Actions List](#) also includes an action **Adjust entire envelope tempo...** This opens a dialog box which offers you the options of adjusting the entire envelope by a percentage or by a set number of beats per minute.

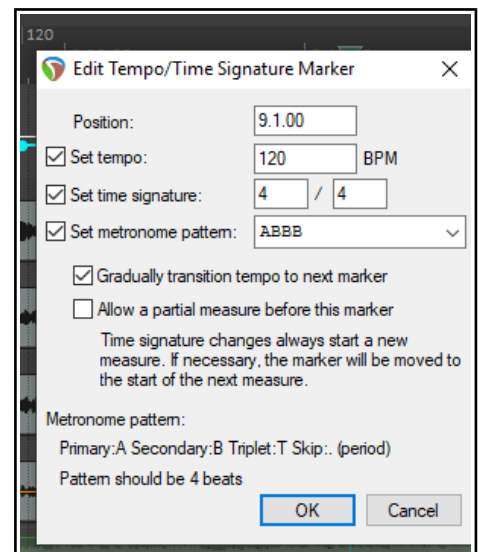

You can also add to the Master a Playrate envelope which can be used to speed up or slow down playback. This envelope is applied to all tracks, audio and MIDI. To do this:

1. Click the Envelopes button in the Track Master to display the Master Envelopes window. Now tick the item **Playrate**. Make sure this item is marked as both Visible and Armed.
2. Close this window.

18.37 More Envelope Tips

The next chapter of this guide – Parameter Modulation and Automation Tips – takes automation and envelopes a step or two further. That chapter includes information that you’re likely to find useful when working with envelopes as explained in this chapter.

This includes some nifty information on how you can customise and color code automation envelope appearance to suit your precise requirements.

18.38 Razor Editing with Automation Envelopes

Razor editing lets you move or copy one part of an envelope to another envelope by dragging it. Razor selection and razor editing techniques are explained in Chapter 2, including a table of the various options and basic mouse modifiers. In addition **Razor edit area** mouse modifiers when working with automation items or envelopes are:

- Shift Alt left drag** Move areas ignoring envelope type and snap.
- Ctrl Alt left drag.** Copy areas ignoring envelope type.
- Shift Ctrl Alt left drag** Copy areas ignoring envelope type and snap.

Here is an example. We might want to ensure that during a section of the song two tracks are automatically panned to move in opposite directions, i.e. against each other.

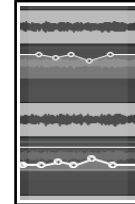
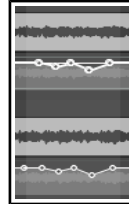
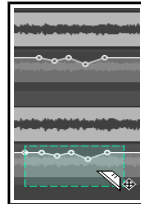
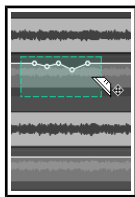

1. Panning is automated on the first envelope and the area is defined with **Alt right drag**.
2. **Ctrl left drag** is used to copy the segment to the other track with snap settings applied.
3. **Select all points in time selection** is applied from the context menu of the lower envelope.
4. **Invert points** is now chosen from the same menu.

Note the option on the envelope tool right click menu **Razor edits in media item lane affect all track envelopes**.

With this option disabled, you can select and move or copy a segment of a media item, or any envelope, or envelopes attached to that media item, or any combination of these. Hidden envelopes will be excluded from the selection.

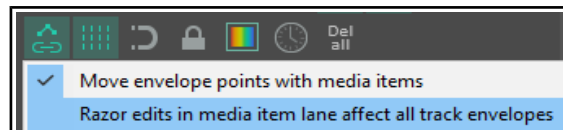

With **Razor edits in media lane affect all track envelopes** enabled, the media items and any/all associated envelopes are essentially locked together when any one is being razor edited. Envelopes will be copied with media items from one item to another even when these envelopes are hidden in the source item and do not already exist on the destination item.

The destination envelopes can be automatically displayed or not, based on the envelope display preferences option **Automatically show affected envelopes when moving media items across tracks**. However, if there is no matching envelope at the destination (for example if you have an EQ low pass frequency envelope on the source track but that FX does not exist on the destination track) then that envelope area will not be copied.

The only difference between razor edits and media item moves in this mode is that with razor edits, if there are no matching envelopes at all on the destination track -- in other words if the edit would result in the entire razor edit being discarded -- then edit will not be allowed.

Your mouse modifiers **Razor edits area left drag** section include available options to **move or copy area ignoring envelope type**. You could, for example, assign these to **Shift alt right drag** and **Ctrl alt right drag** respectively. This, for example, would allow you to copy a section of an envelope from (say) a volume envelope to a trim volume envelope.

This feature is specific to razor edits. In this mode, areas are moved based on what you see is what you get. It would not make sense to automatically create envelopes in this mode. If you were moving one envelope razor edit area, REAPER would have to create literally every possible envelope on every track that you moved across.

Automation – Envelopes and More

Make yourself familiar with the various mouse modifiers outlined in the [razor edits section](#) in Chapter 7.

It is also important to remember that your [ripple editing](#) settings will affect how razor editing behaves when copying or moving automation.

Note: Razor editing can also be applied to envelopes on the master, except for tempo envelopes.

Examples: #1: With **Razor edits affect all track envelopes** disabled

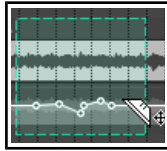

1 ...you could select and move or copy this ...

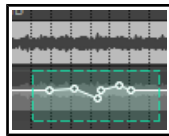

2 ... or just this ...

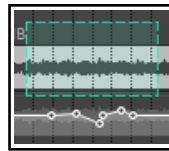

3 ... or this.

With this option on, you could do 1, but not 2 or 3. Hidden envelopes would also be included.

#2: Again, with **Razor edits affect all track envelopes** disabled, using a mouse modifier assigned to **Copy area ignoring envelope type** and with **ripple editing** off ...

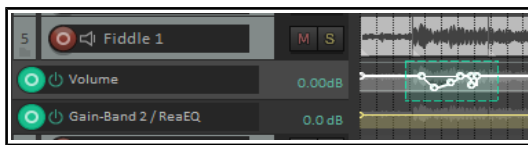

... an envelope segment can be selected ...

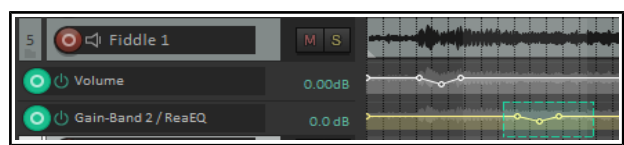

... and copied to a different envelope type ...

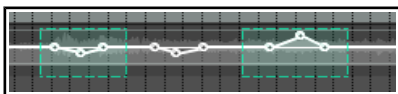

... or you could select multiple segments of an envelope and copy them to another envelope of the same type, whether this option is on or off.

Razor Edit Envelope Mouse Modifiers and Actions

Razor editing as much as any other feature of REAPER is something that different people will want to use in different ways. Core razor edit mouse modifiers are covered in [Chapter 7](#). REAPER also includes a **Razor edits envelope, left drag** context, as shown (right). These actions apply only to envelopes in lanes.

Move or tilt envelope vertically: moves selected segment of envelope up or down.

Expand or compress envelope range: increases (up) or decreases (down) distance between highest and lowest point in the selection.

Expand or compress envelope range towards top bottom: similar to **Ctrl left drag** but also moves entire selection up or down.

Mouse modifiers	
Context:	Razor edit envelope area left drag
Modifier	Behavior
Default action	Move or tilt envelope vertically
Shift	
Ctrl	Expand or compress envelope range
Shift+Ctrl	Expand or compress envelope range toward top/bottom

Customize Mouse Modifier Preferences

These can be found in your **Options, Preferences** window Double click in the Behavior column for any mouse modifier for a list of alternative tasks that can be assigned to that modifier.

Browse the Actions List

REAPER's [Action List](#) includes literally dozens of razor edit actions that can be assigned variously to the contexts Arrange view right drag, Media item bottom half left click, Media item left drag, Media item left click, Razor edit area left click, Razor edit area left drag and Track left drag.

For example, if you need to copy a series of automation items or envelope segments within a project you could run an action to set the mouse modifier for Razor edit area left drag to **Copy areas on one axis only ignoring envelope type**, then at the end of that session reset it to its original default **Move areas**.

To explore other options, open the Actions List and search for the word **razor**.

Tip: Check out also the earlier section on [Power Editing](#) for more tips about working with razor edits.

18.39 Automation with Hardware Output Sends

If using hardware output sends with any of your tracks you can automate the Volume, Pan and Mute parameters for these sends. These items will appear in the track's envelopes window as shown on the right.

In the example shown, we have a send from Track 1 to an Audio Hardware Output. We can now control the send volume with an envelope.

We can even go one better. We can use fader movements to shape this envelope, but without using Write mode for any other envelopes that we may also have created. This can be done from within the track's routing window.

In the screen shot below automation mode has been set to Touch from within the routing window, just for that one envelope. You could now play your track, adjusting the audio hardware output send fader in the window shown below to adjust the send volume level and create your envelope. You can also do this with Track Send envelopes.

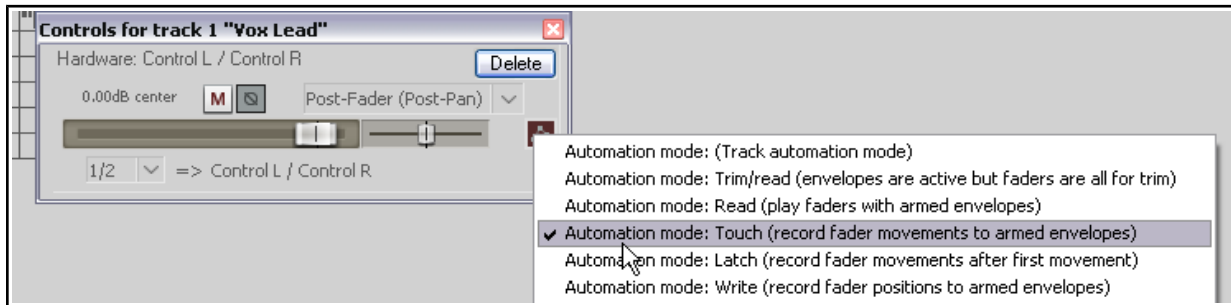
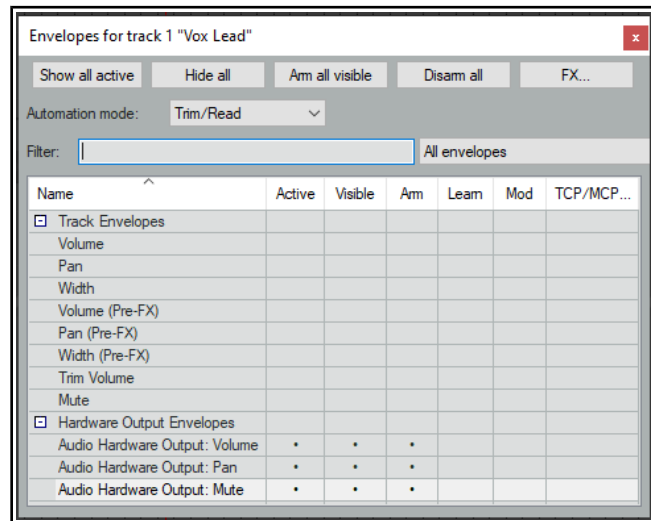

18.40 Automation Items

REAPER allows you to define an entire automation envelope or a section of an envelope (including [video processor envelopes](#)) as an automation item, and then later apply that automation item to any media item or items in the same or any other project. The concept itself is not complicated, but there are many options and variations in the ways in which you can apply it. Before exploring these, let's start by looking at a practical example, using a low frequency oscillator to shape an envelope.

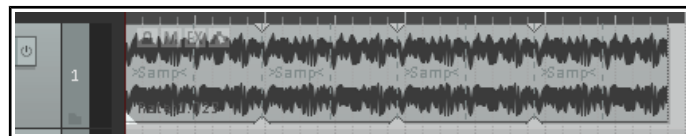

Example

This example is designed to introduce you to the basic concept of automation items.

1. First, we import a sample into a new track. We then extend the looped sample to repeat the pattern (as shown, top right).
2. To add a low frequency oscillator to this item we first select the item and add a volume envelope.
3. We then make a time selection to cover the period of the original sample. Next, we right-click over the envelope and choose **Automation items** then **Insert new automation item** from the menu. This creates an automation item (with a title bar at the bottom). We right-click over the title bar and choose **Properties** to open the Properties dialog box.
We adjust the parameters as we wish. An example is shown here. This creates points and defines the envelope shape. We close this box when finished.
4. We can position the mouse just inside the item name area's right boundary (at the bottom of the item), then click and drag all the way to the end of the item, as shown below.

Automation – Envelopes and More

Our automation item now contains (in this case) four identical segments. Making a change to any one of the segments will automatically make the same changes to the other three segments. These changes could include, for example, edits made manually, or adjustments to the Automation Item Properties, including LFO parameters.

The next couple of pages explain automation items and how to use them in more detail. Keep in mind that when working with automation items normal windows techniques apply – e.g. **Click** to select, **Ctrl Click** to build a selection, and **Shift Click** to select a range of contiguous items.

Note: Automation items cannot be used with tempo envelopes.

Understanding Low Frequency Oscillation (LFO)

LFO is an electronic signal (usually below 20 Hz) that is used to create a rhythmic pulse. It can be used to modulate synthesizers and audio material in the production of electronic music, for example to create effects such as tremolo, phasing and vibrato. LFO controls include:

LFO Shape: None, Sine, Triangle, Saw, Square or Parametric.

Frequency: the number of times the shape occurs within the item.

Baseline: raises or lowers the envelope baseline.

Amplitude: determines the depth of the modulation: the higher the amplitude, the greater the curve.

Skew controls: these vary the intensity of each occurrence within the item.

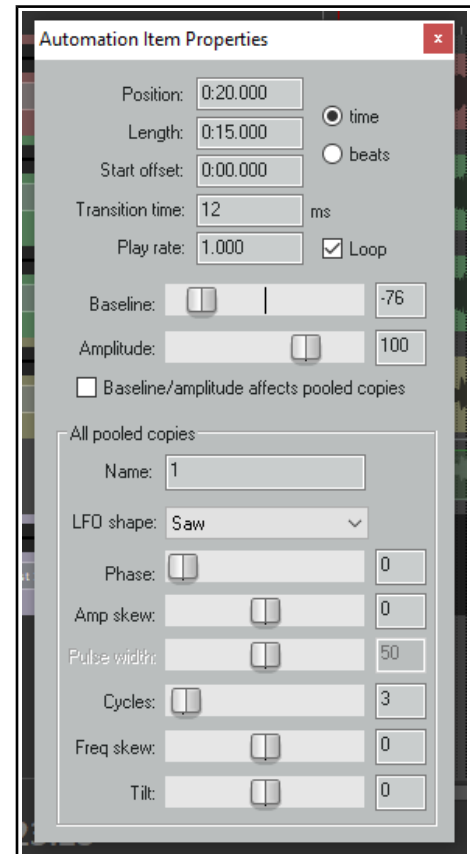
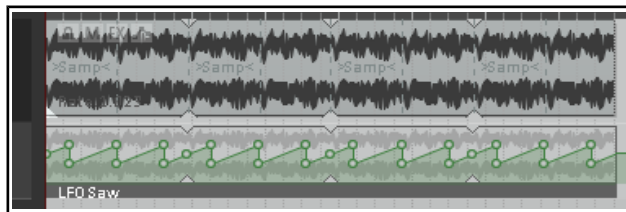

Working with Automation Items

In order to do this...	Do this...
Create new empty automation item on envelope	Make time selection, right-click within time selection on envelope, choose Automation items, New automation item or Hold Alt while dragging from left to right just below the envelope.
Create new automation item when writing automation to envelope	Enable the Preferences option (Editing behavior, Automation) to Always create new automation item when writing automation .
Insert a saved automation item on to an envelope	Position cursor. Right-click on envelope, choose Automation items, Load , then Load... Select item name and click on Open .
Add a LFO to an automation item, and/or change other properties	Double-click on the item's title bar (at bottom of item) to open the Automation Item Properties dialog box. Select LFO shape (parametric, triangle, saw or square) and adjust other parameters as required (see below). Close dialog when finished.
Convert existing envelope into automation item	Add points to envelope. Make time selection, right-click on envelope within selection, choose Automation items, New automation item .
Convert item to ordinary envelope segment	Right-click on the item's title bar, choose Delete automation item preserve points .

Up and Running: A REAPER User Guide v 7.31

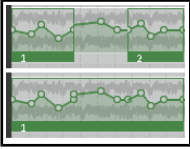
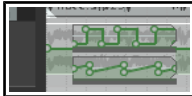
In order to do this...	Do this...
Disable envelope outside automation items.	Right-click on envelope, enable the toggle option Disable envelope outside automation items . Also known as "automation items only mode."
Edit automation item	Add, move, delete points etc. in exactly the same way as with any envelope. To change LFO and other settings, double-click on item's title bar to open the Automation Item Properties window.
Name or rename an item	Open Automation Item Properties , type the name.
Define custom automation item transition time	Enter transition time in Automation Item Properties dialog.
Move automation item	Click and drag left or right on the item's title bar, or up or down to another envelope, on the same or a different track or item.
Move item contents	Hold Alt while dragging item's title bar left or right.
Copy automation item to another location	Ctrl click (to copy unpooled) or Ctrl Alt click (to copy pooled) on title bar, and drag to destination on same or another envelope, on any track, <i>or</i> Select item, then Alt click drag below envelope at required location. 
Unpool automation item	Choose Remove from pool from item's right-click context menu.
Use automation items with FX parameters	Insert FX (e.g. compressor or delay) into the FX chain and add a parameter envelope in the normal way. Create and apply items as per usual.
Mute automation item	Right-click on the item's title bar, choose Mute (toggle).
Extend/copy automation item contents	Click and drag from just inside the item's title bar right edge to the right, or from left edge to the left.
Extend automation item, collecting existing points	Ctrl click from edge of title bar outwards. As the item is extended, existing envelope points are collected into it.
Loop/unloop an item	Enable/disable loop option in Automation Item Properties dialog.
Stretch/shrink item	Alt click drag left/right from item title bar edge.
Join automation items together	Ctrl click on title bars of each item to be joined,. Right-click over any one title bar, choose Glue . The items will be made into a single item, including any envelope portions between them.
Save automation item	Right-click on item title bar, Save... , select folder, type name and Save .
Delete automation item	Right-click on item title bar, choose Delete .
Split at cursor position	Right-click on the item's title bar, choose Split .
Duplicate automation item as pooled	Right-click on the item's title bar, choose Create pooled duplicate . Any edits made to any item in the pool will be made to all items in the pool.
Duplicate automation as unpooled	Right-click on the item's title bar, choose Create unpooled duplicate . Each item can be modified independently of any/all other items in the pool.
Use multiple automation items simultaneously on the same envelope	By creating multiple automation items and dragging them around as required you can enable two or more automation items to be used simultaneously on the same envelope.s 

Automation – Envelopes and More

Notes:

- ◆ To ignore snap with any of the above click-drag actions, hold also **Shift** while performing the action.
- ◆ The main difference between **pooled** and **unpooled** items lies in how they behave when edited. An unpooled item is completely independent and can be edited without any other item being affected. Changes made to any pooled item, however, will be applied to all items in its pool. However ...
- ◆ When editing pooled items via the **Automation Items Properties** dialog, changes made to parameters included in the **All pooled copies box** will be applied to all items in the pool. There is also an option you can tick for **Baseline/amplitude to affect pooled copies**. Other changes made within the Automation Item Properties box will only be applied to the individual item being edited.
- ◆ If the option to **Move envelope points with media item** (Options menu) is enabled, then when a media item is cut, copied, pasted, moved, duplicated, etc., any automation items attached to it will be moved with it.. If the portion of the media item includes only part of an automation item, then only that part will be moved or copied with the automation item.
- ◆ Where automation items exist within regions, they will be moved and copied with the regions.
- ◆ A project's automation items can be managed from the **Automation Items** page of the **Project Bay**. This shows all automation items currently used in the current project. You can perform many functions described in this section, for example rename any item or mute it or adjust the volume of any instance.

Automation Item (AI) Preferences, Actions, Mouse Modifiers, Options – and the Media Explorer

Automation Item Preferences

The **Editing Behavior, Automation Items** and **Editing Behavior, Envelope Display** Preferences (Chapter 22) include options to manage looping, pooled item behavior, and underlying envelope behavior.

Actions

The **actions list** includes various automation item commands and actions, including (but not limited to):

- Options: Loop new automation items by default.** (toggle)
- Options: Always create new automation items when writing automation**
- Options: Automation item baseline/amplitude edits affect pooled copies**
- Options: Automation items attach to the underlying envelope on both sides/right side ****
- Options: Automation items do not attach to the underlying envelope ****
- Options: Chase non-FX envelopes to automation items when underlying envelope bypassed**
- Options: Reduce envelope data when recording or drawing automation**
- Options: Remove points from underlying envelope when creating automation items**
- Options: Trim content behind automation items when editing**
- Options: Add edge points when moving envelope points with items****
- Options: Add edge points when ripple editing or inserting time ****
- Options: Add edge points when moving multiple envelope points ****
- Options: Reduce envelope point data when recording or drawing automation ****
- Envelope: Add edge points to automation item**
- Envelope: Convert all project automation to automation items**
- Envelope: Enable/disable envelope outside of automation items (AIs)**
- Envelope: Enable/disable envelope outside of AIs for all envelopes on selected track**
- Envelope: Enable/disable envelope outside of AIs for all envelopes in project**
- Envelope: Enable/disable envelope outside of AIs for all visible track envelopes**
- Envelope: Mute automation items**
- Envelope: Glue automation items**
- Envelope: Set loop points to automation item**
- Envelope: Set time selection to automation item**
- Envelope: Split automation items**
- Envelope: Toggle automation item loop.**

** available on envelope tool on default toolbar

Moreover, all of the commands described in the above table are available as actions in REAPER's [Actions Editor](#) and as such can be assigned to [keyboard shortcuts](#), [toolbar icons](#), and/or [custom menus](#). See Chapter 15. Other actions for options not on the menu include toggle actions to control underlying envelope behavior.

Mouse Modifiers

REAPER's mouse modifiers include the contexts **Automation item** (left drag, double-click) and **Automation item edge** (left drag). All the mouse actions in the above table are listed there, as well as some further options. You can [change default mouse modifier assignments](#), rearranging modifier key behavior as you wish. There is also a mouse modifiers preferences option **Edits affect all pooled items at the same position**.

Also, the **Envelope lane** mouse modifier **left drag** context includes several actions and options for drawing copies of selected automation items.

Toolbar Envelope Button

In addition, you can right click the toolbar envelope button to access several toggle options to determine how automation items interact with underlying envelopes. These are:

Bypass underling envelope outside of automation items

Automation items do not attach to the underlying envelope

Automation items attach to the underlying envelope on right side

Automation items attach to the underlying envelope on both sides.

Chase non-FX envelope to automation items when underlying envelope is bypassed.

These commands are also available on the envelope right click menu, as well as:

FX envelope overlapping automation item combination mode.

Automation Item Behavior

As well as managing preferences, you should familiarise yourself with a small number of rules governing automation item behaviors:

When automation items are moved they will obey your media item preferences snap start/end options.

When recording automation creates new items, smaller items will be created if they intersect with existing items.

When trim-behind is used to split automation items, your pool on split preference settings will be obeyed.

The Media Explorer

Automation Items can be managed from the [Media Explorer](#) like other media items. Simply navigate to the correct directory to preview. Right click over any item name for a menu of options for inserting into the project.

Parameter Modulation and Automation Tips

19 Parameter Modulation and Automation Tips

Note: This section is for experienced users only and is not suitable for beginners. You might notice that the track panels in some screen shots are from earlier REAPER versions. This should not cause you any problems.

19.1 The Concept

Parameter modulation is best undertaken by more experienced mixers. This chapter serves as an introduction, but inevitably (because of the complexity of the topic) it is not really pitched at the relatively novice user.

Parameter modulation takes REAPER's routing, channel splitting, automation and sidechaining capabilities to new levels. You should probably not attempt this chapter unless you already have a sound grasp of these and other concepts. If necessary, turn back to the chapter [More Routing Examples](#) and work thru it again. Parameter modulation at its simplest means using the level of a track's volume or one or more FX parameter to control the behavior of one or more other FX parameters on the same track or on a different track or on a number of tracks. Don't worry if at this stage you find this difficult to comprehend. The concepts of what this is and how it works will become clearer after you have worked thru some examples.

One relatively simple example might relate to the application of a chorus plug-in to a guitar or bouzouki track. Suppose that we wish to vary the wet level of the chorus throughout the track. We could, of course, accomplish this with the use of automation envelopes. However, this might involve quite a lot of work and the envelopes might need frequent readjustments. Let's take this idea a step further. We can define a relationship between the instrument's volume and the wet chorus level, so that as the volume increases the mix becomes drier, and vice versa. The chorus will seem to tail away when the instrument is played more forcefully and become gently more present during the quieter passages. Instead of creating a series of envelopes for our chorus, we can use parameter modulation so that the chorus mix will respond automatically and in real time to changes in volume.

Incidentally, this particular example can create an interesting effect of space and distance on the instrument, but as with most of the other examples throughout this User Guide, that is not the main point of the exercise.

Changes in an effect like chorus are relatively obvious to the human ear. The main point of this exercise is to show you how parameter modulation is set up and used. It's then up to you to use and apply it in ways that you'll find will bring new life and vigor to your own mixes.

19.2 The Interface

We'll shortly look at some examples to show both how parameter modulation works and how you can go about using it. First, here are a few basic terms and concepts.

When you select a parameter to be modulated, you will initially see the window shown here (right). In this example, parameter modulation is about to be applied to control a compressor's threshold on a vocal track. This initial window features five basic controls. These are:

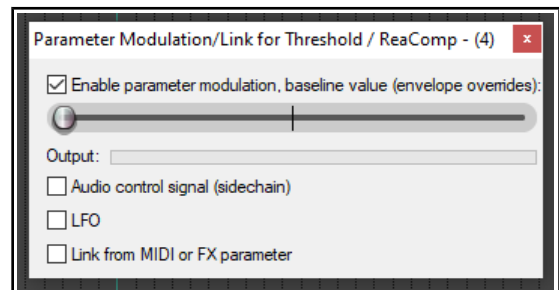

- **Enable parameter modulation, baseline value.** This needs to be ticked for the parameter modulation (PM) to be applied. Unticking this box sets the PM to bypass.
- **The horizontal baseline value fader.** This determines the starting value of the parameter being controlled. We'll come to an example shortly. Initially, leave this at its default setting (fully left).
- **Audio control signal.** Ticking this option will open a window which is used to define both which track (or tracks) contains the audio signal that is to be used to control the parameter being modulated, and how you want the modulation to be applied. Don't worry, we'll get to an example soon!
- **LFO.** This option allows you to use a low frequency oscillator signal (such as sine, square, triangle, etc.) to generate a tone to control the parameter being modulated. This is more likely (but not exclusively) to be used when it is a synthesizer parameter that is being modulated.
- **Link from MIDI or FX parameter.** This option allows you to link one FX parameter (on a track or media item) to another. An example might be to ensure that as a track or item is compressed more heavily, some presence is added to the EQ (to compensate for loss of dynamics). Another might be that as the wet/dry balance on a delay effect is adjusted to add more delay, the pan position of the delayed signal is automatically moved further out. The possibilities really are endless.

[Linking from MIDI events](#) will be covered separately, towards the end of this chapter.

19.3 Defining a Parameter for Modulation

Parameter modulation can be used with track FX and/or take/item FX.

Illustrated below is an example of the Parameter Modulation window with just the **Enable parameter modulation** and **Audio control signal** options enabled. The table below that explains the main settings, what they do and how they are used. We will then go on to work thru some examples to show you how parameter modulation can be used.

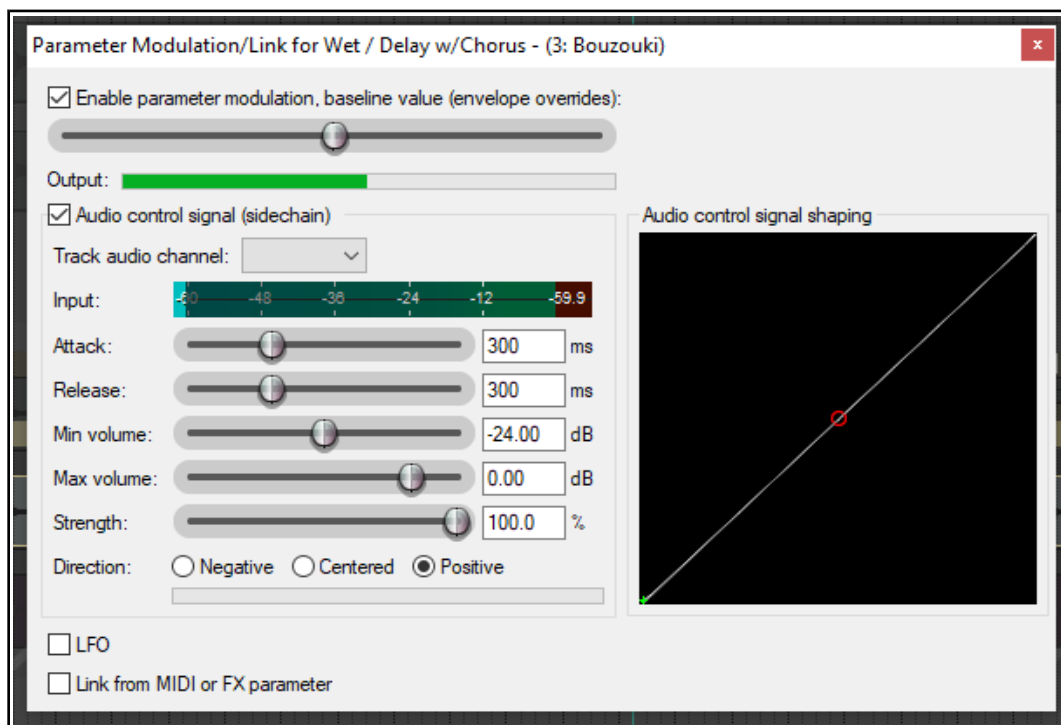

Item	Description
Enable parameter modulation, baseline value with Fader	The checkbox enables/disables parameter modulation on this parameter. The fader sets a default value for the specified parameter that is to be modified. However, if an automation envelope exists for the same parameter then that envelope will determine the baseline and this setting will be ignored.
Audio control signal	Enables/disables control of the parameter by the audio signal in the specified Track audio channel .
Track audio channel	This specifies which audio channel(s) – for example, 1/2 or 3/4 – contain the audio signal that is used to control the specified parameter. The selection of channels available will depend on how many channels have been previously defined for the track. In more straightforward applications, you will want to choose channels 1 + 2. This will ensure that the parameter is controlled by the audio signal on its own track. However, as you will see soon, you can choose a source other than channels 1 + 2 if you want an FX parameter on one track controlled by the audio signal from a different track. The latter case would be an example of sidechain parameter modulation.

Parameter Modulation and Automation Tips

Item	Description
<p>Attack and Release</p>	<p>These two factors determines the speed with which changes in the level of the incoming signal will be applied to the parameter. They work in a similar way to Attack and Release on a compressor.</p> <p>A higher attack setting will cause the parameter to respond more slowly to changes in volume in the source audio channel.</p> <p>A low release speed will cause the modulation to be adjusted rapidly as the volume then falls. A higher speed will hold the modulation for a longer period before doing so.</p> <p>Generally speaking, the higher the attack and the release settings the more gradual will be the parameter modulation response. The lower these settings, the more sensitive and immediate will be the response.</p>
<p>Min Volume and Max Volume</p>	<p>These determine the range within which the signal on the track audio channel will be used to modify the FX parameter.</p> <p>For example, in the illustration shown, the parameter in question (chorus wet mix) on the track in question (track 4, Bouzouki) will only be controlled by the audio signal on channels 1 and 2 when its volume falls within the range - 24 dB to - 0.53 dB. If or when the signal is quieter than -24 dB or louder than - 0.53 dB the parameter modulation is in effect set to bypass.</p>
<p>Strength and Direction</p>	<p>These determine the nature and the intensity of the relationship between the incoming audio signal and the parameter being controlled. For example, set to 100% positive as the incoming audio signal increases or decreases, then the parameter being controlled will also increase or decrease to the same degree. At 50%, the relationship will still be positive, but more moderate. You can think of this as being conceptually similar to a ratio control on a compressor.</p> <p>Likewise, a setting of 100% negative means that as the incoming audio signal increases, the parameter being controlled will decrease in the same proportion, and vice versa. At 50%, the relationship will still be negative, but more moderate.</p> <p>At 0%, the effect will be completely neutral.</p>
<p>Audio Control Shaping Signal Graph</p>	<p>This graphical control helps shape the behavior of the parameter that is being modified.</p> <p>For example, if the direction is set to positive, then pulling the small red handle (in the centre of the diagonal line) on the graph fully to the bottom right corner will result in more modest increases in the value of the parameter being modified.</p> <p>On the other hand, pulling the small red handle (in the centre of the diagonal line) on the graph fully to the top left corner will result in greater increases in the value of the parameter being modified.</p> <p>Don't worry, we'll work thru an example soon.</p>

The best way for you to understand how parameter modulation works is to try it out in practise. This first example will use several of the PM window controls. We will first select a parameter to be modulated, then set its baseline fader level, and then select the required audio control signal. Finally, we will define the relationship between the audio control signal and the parameter being modulated.

19.4 Defining a Parameter for Modification

To select an FX parameter to be modified, follow either of these sequences:

1. Open the track or item plug-in's FX window.
2. With the mouse, click on the control for the parameter that you wish to modulate.
3. Click on the **Param** button in the plug-in window, then choose **Parameter modulation/MIDI link** from the menu that is then displayed (as shown here).

Or:

1. Display the track's **Envelopes/Automation** window and click on the **+** for any plug-in to display the list of its controls.
2. Click on the **Mod** button for any parameter that you wish to have modified by an audio signal. You will then see a small check box next to the **Mod** text for that item in the Envelopes window (as shown right).
3. Close the Envelopes/Automation window.

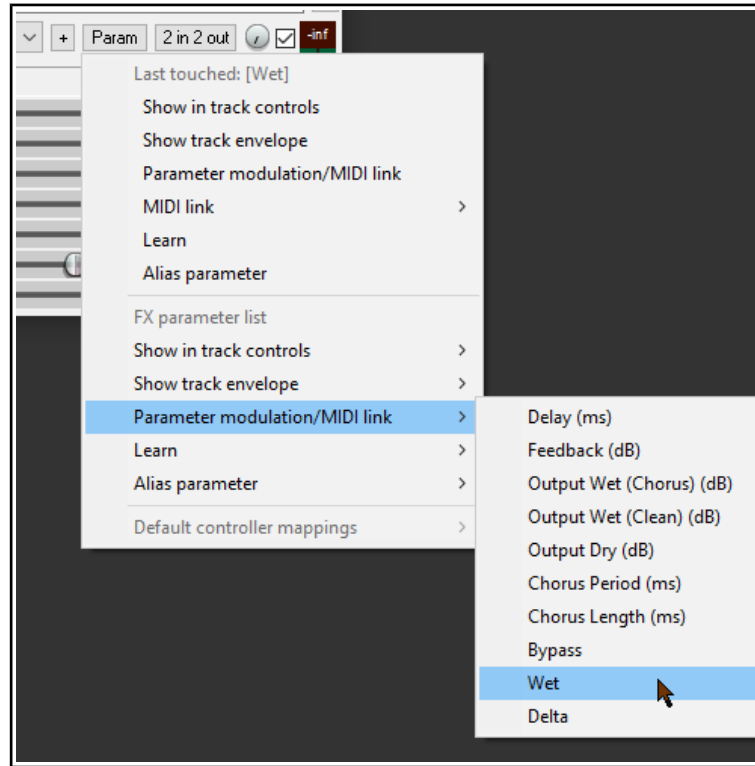

Notice (right) that the name of the last touched parameter – the one to which parameter modulation will be applied – is shown dimmed at the top of the **Param** button menu.

19.5 Parameter Modulation with Audio Control

In this first example, we will insert a plug-in such as chorus into a track's FX chain, then use that track's audio signal to control the way that plug-in behaves.

Example

1. Open the file **All Through The Night** and save it as **All Through The Night MOD1**.
2. Adjust track faders to get a reasonable mix. This could be Volume at -0.5 dB, center, Guitar Body at 0 dB, 55% left, Guitar Neck at 0 dB, 63% right, and Bouzouki at -4 dB, 15% left.
3. Solo the **Bouzouki** track. While working thru this example, this is the only track that will be needed.
4. Insert the **JS: Delay/delay_chorus** plug-in into this track's FX chain, and set the various parameters as shown here.
5. Click once on the **Wet/Dry mix (rotary)** in this plug-in. Notice that currently this is set at 0.0.

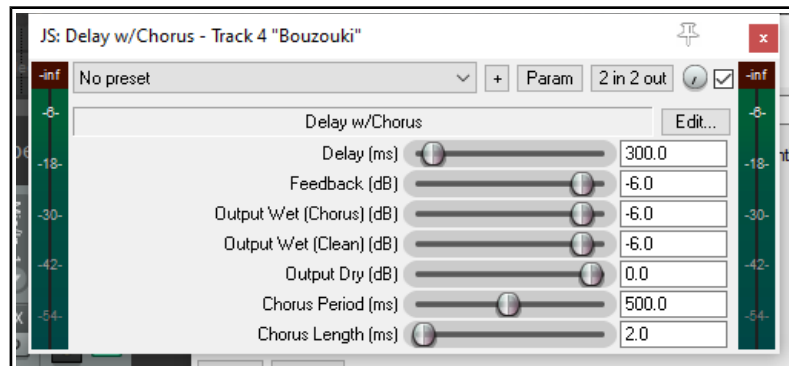

Parameter Modulation and Automation Tips

- Click on the **Param** button, then choose **Parameter Modulation/MIDI link** from the menu. This will open a parameter modulation window for the output wet parameter. Enable the option **Audio control signal** and select as the **Track audio channels** 1 + 2. Play the track.
- The wet rotary on the plug-in was initially at 100%, as shown here. However, as you adjust the baseline fader (in the PM window) while the track is playing, the wet value in the Chorus window (shown to the immediate right of the 2 in 2 out button) is also adjusted. Leave it with a wet mix level of about 50%.
- Set the various items in the **Parameter Modulation** window as shown below and play the track. You should notice the **wet mix** element of the chorus being faded down for louder notes and passages and up for quieter notes and passages.
- Now experiment! You should find that:
 - Moving the **Attack** and **Release** faders left will result in the wet mix chorus fader movements becoming more jerky. Moving them right should make them smoother.
 - Moving the **Strength** fader (negative) to the right will cause the wet mix chorus fader to be faded down for louder notes and down up quieter ones. Selecting positive reverses this.
 - Moving the **Min Volume** fader left will lower the threshold at which the parameter modulation is applied. Moving it right will raise the threshold.
- When you have finished experimenting, adjust the settings to those shown here.

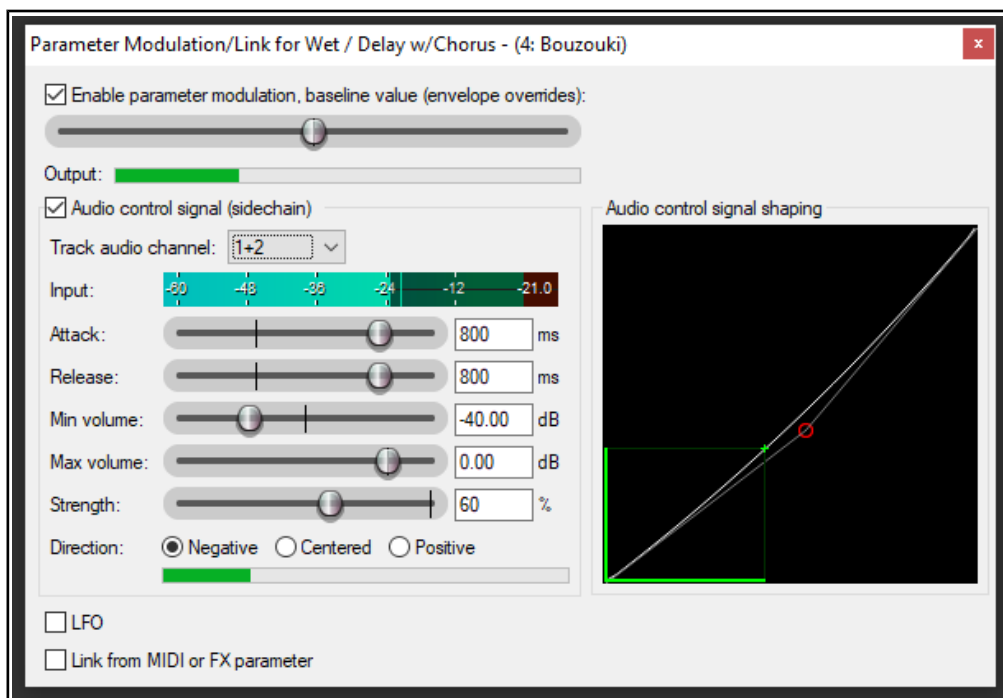

- This instrument becomes louder as the song progresses. Play it, with the Bouzouki unsoloed. By the end, there is less chorus being applied to the bouzouki.
- Now play the song again. Drag hold of the handle on the graph, and use your mouse to drag it to the lower right position. Notice that the movements of the wet mix fader now become more modest.
- Now drag hold of the handle on the graph, and use your mouse to drag it towards the top left corner of the graph (as shown below). Notice that the movements of the wet mix rotary now become sharper and the wet mix level reaches lower values.

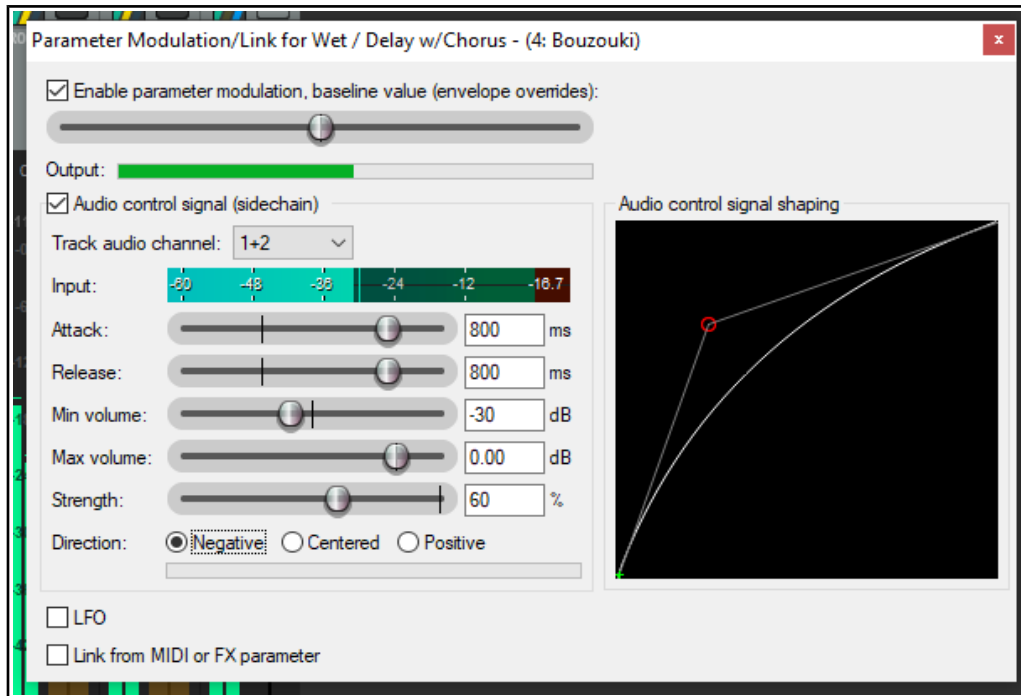

14. Restore the graph to its earlier position (shown at step 10) when you have finished. Save the file.

19.6 Using an LFO Shape with Parameter Modulation

Now let's have some fun and use a low frequency oscillator to further modify the way parameter modulation is applied. Try disabling the audio control and turning on the **LFO** option. Start with some fairly conservative settings as shown below. Selecting the **Tempo Sync** option should help make for a fairly safe outcome!

The **Speed** setting controls the signal repeat rate.

Strength determines how much of the LFO signal is applied.

You can also adjust the default **Phase** setting.

As in the previous examples, **direction** can be negative, centered or positive.

Notice also the **Learn phase** button: this can be used to assign control to a MIDI or OSC device.

Compare how the track now sounds with PM enabled and disabled. If you are familiar with working with low frequency oscillators, you might wish to be a little more adventurous. Otherwise, just save the file as **All Through The Night MOD1 LFO**.

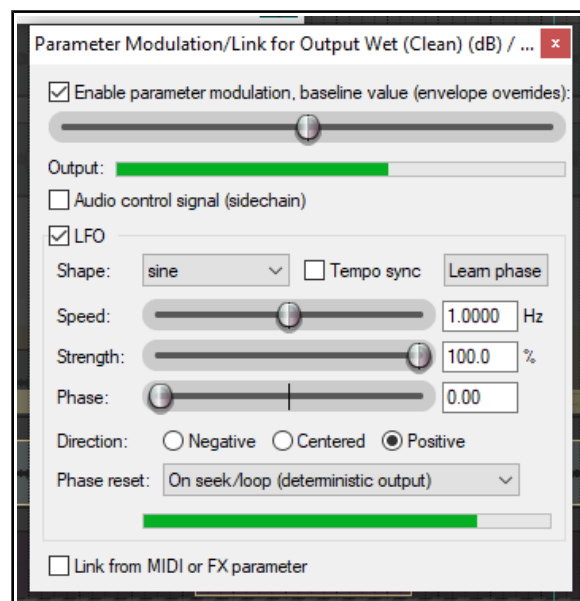

Parameter Modulation and Automation Tips

19.7 Using Parameter Modulation for Dynamic Compression

In this next example, you will use parameter modulation to dynamically adjust the settings to compress a vocal track in such a way that the threshold will automatically be adjusted during the louder passages. This gives you a more precise control over the compressor's operation than would otherwise be possible.

Example

1. Open the file **All Through The Night MOD1** and save it as **All Through The Night MOD1A**.
2. Pan the Vocal track to the center and set its volume at about -0.5 dB
3. Insert an instance of **ReaComp** into the FX Chain for the **Vox** track.
4. Set the **Threshold** to about -24 and the **Ratio** somewhere around 4:1. Set **Knee size** to around 15dB. Set the **Wet** gain to about +1.6dB.
5. As you play the song, adjust the settings to suit. One possible set of suitable parameter values is shown on the right.
6. As you play the track you might feel that the compression at times sounds about right but at other times is being applied too heavily. This is where we can use the track's own volume level to control its parameters. In this example, we will do this with the threshold only, but it could also be done with the ratio if you wished to.
7. Click once on the **Threshold** fader.
8. Click the **Param** button for this plug-in.
9. From the menu, then choose **Parameter modulation/MIDI link** then **Audio control**.
10. Study the suggested settings shown in the screenshot below and adjust your settings accordingly as you play the song. Refer to the comments below.
11. Notice in particular how the attack and release setting levels, the shape of the curve and the volume settings all help prevent the threshold from being adjusted too radically.
12. Save and close the file when finished.

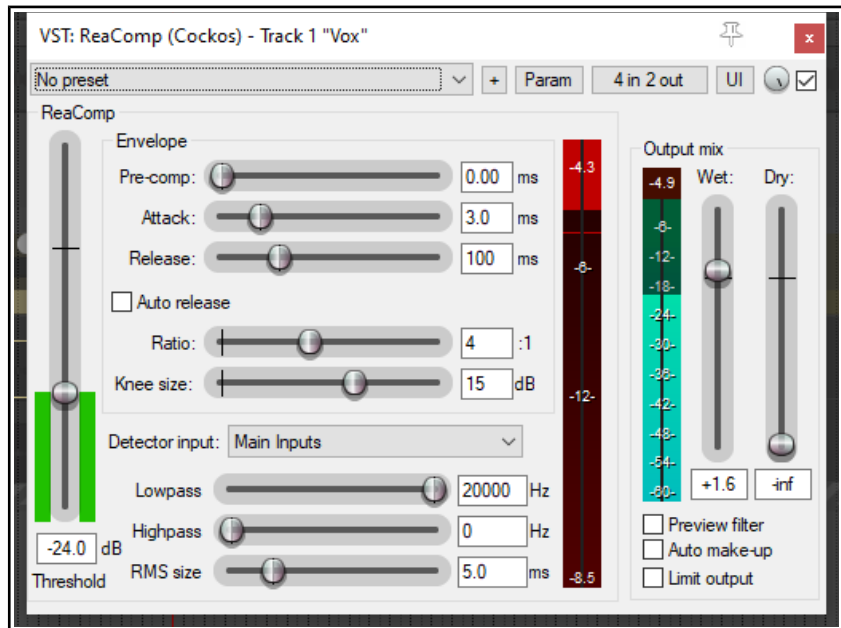

Notes

By setting the Min Volume in the PM window to the same level as the Threshold in the ReaComp window we ensure that the PM is only applied when the vocal is at its loudest. The Strength setting of 33% effectively means that for every 3 decibels by which the volume exceeds the min volume, the threshold will be lifted by about 1 dB.

Note: When you are using Parameter Modulation you should be prepared to tweak the various parameters carefully. Sometimes even the slightest change to a parameter value can significantly change the result. If at first you do not seem to get any result, experiment especially with adjusting the baseline value setting.

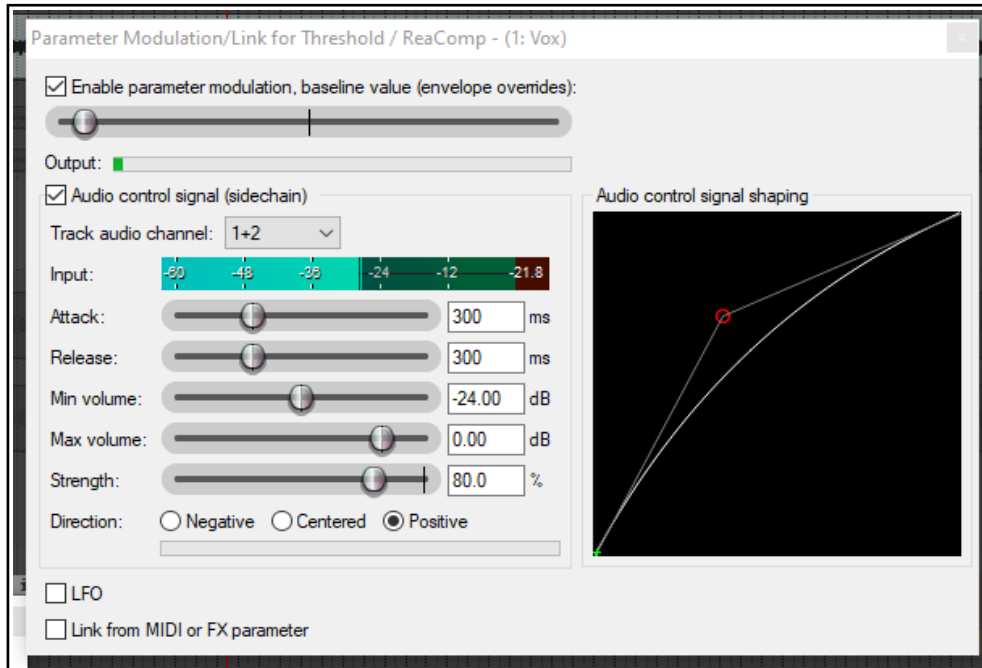

19.8 Bypass Mode

Whenever you create a parameter modulation for a parameter, a small box is added next to its name in the Envelopes/Automation window. This can be used to enable any of your parameter modulations, or set them to bypass mode (in which case they are of course ignored). Otherwise you can do this from inside the Parameter Modulation window itself.

In the example shown here, PM settings exist for the Threshold (currently enabled).

Also, note that clicking on the word **Mod** for an item where parameter modulation already exists will cause that window to be opened (even if it is currently disabled) so that you can view and/or edit the settings.

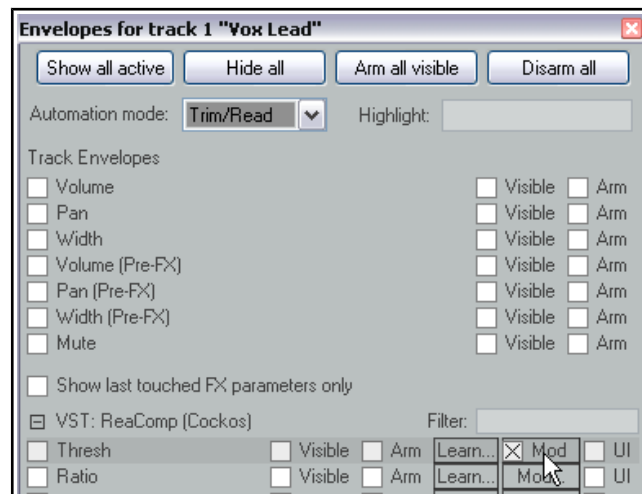

19.9 Parameter Modulation Under Parameter Control

By linking parameters you can use dynamic changes in one FX parameter to directly control another. In this next example you will do just this, linking a track's EQ gain with its compressor threshold, so that whenever the compression threshold is raised a little more warmth is automatically added to the track.

1. Open the file **All Through the Night MOD1A** and save it as **All Through the Night MOD1B**.
2. In the vocal FX chain, add an instance of ReaEQ (after ReaComp). Select Band 2. Set the Frequency to about 180 Hz, the bandwidth to about 2.00 octave and the Gain to 0.0 dB.
3. With the ReaEQ window open, click on the Band 2 Gain control, then the **Param** button, then **Parameter modulation/MIDI link** to open the Parameter Modulation window. Select the option **Link from MIDI or FX parameter**.
4. Click on the large button below the **Link from MIDI or FX parameter** option and choose **ReaComp** then **Thresh** (as shown here).
5. Before playing the song, adjust the baseline value fader to restore the Gain on Band 2 in ReaEQ to 0 dB.

Parameter Modulation and Automation Tips

- Set the **Offset** fader to 10% and the **Scale** to +100% (see notes below).
- Play the song and save the file.

In the examples at 19. 5 and 19. 6 parameter modulation was used to create quite a dramatic effect. In the examples at 19. 7 and 19. 9 the effect is more subtle.

The two controls **Offset** and **Scale** can be used to control the extent to which the controlling parameter (in this example the compressor's threshold) modifies the controlled parameter (in this case the EQ band gain).

The Offset fader increase (to the right) or decreases (to the left) by a specified percentage the value of the parameter being modified

The Scale fader ranges from -100% to +100%. At -100% the relationship between the controlling parameter (threshold) and the controlled parameter (EQ band 2 gain) will be 100% negative: the EQ gain will be lowered exactly as the threshold is raised. At +100% the relationship will be 100% positive and the opposite will occur.

If you just want to control the whole range of the target parameter then just set the Baseline [B] slider to the left (0%), Offset [O] to 0% and Scale [S] to 100%.

To control just part of the target parameter's range, first of all, work out what that part is in % terms. For example, consider an EQ gain band with a range of -24 dB to +24 dB and you wish to control the value between -12dB and +12dB. The percentage range is accordingly from 25% to 75%.

Make sure that you can see the target parameter on the FX's GUI and the Parameter Modulation window and set the Scale [S] value temporarily to 0%. Drag the Baseline [B] slider 25% to the right and you should see the target parameter change to -12dB. Now set the Scale to 50% (that is 75% - 25%). That's it. There is no need to adjust the Offset.

In fact, you won't need the Offset often. It can be used to slide the range up or down. Please note that the actual change is determined by the Offset % multiplied by the Scale %. Let's look at [B] = 50%, [O] = 0% and [S] = 25%, this results in a range of 50% to 75%. If we now set [O] to -40% the range changes to 40% to 65% the change is [O] x [S], that is -40% X 25% = -10%.

19.10 Using Parameter Modulation with an Envelope

When you have an [automation envelope](#) enabled for a parameter being modulated, then the baseline value will be determined by that envelope rather than by the baseline value fader in the parameter modulation window. When this happens, the baseline value that is actually applied will itself vary (according to the envelope) throughout the song. This can produce some interesting results.

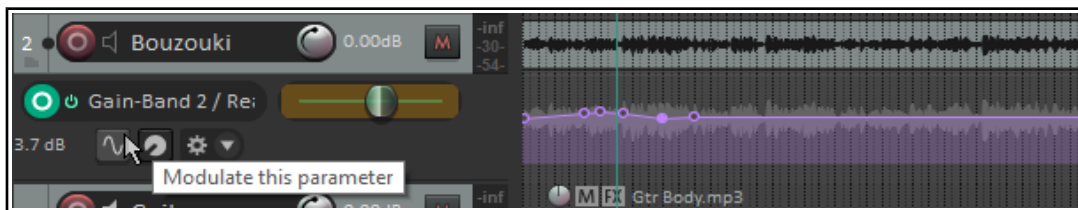

Here we have added an envelope to control the **Band 2 EQ Gain** setting of ReaEQ. By clicking the **Modulate** button in the envelope lane we are able to open the Parameter Modulation window and take the necessary steps to ensure that the EQ gain will respond automatically to changes in the strength of the audio signal on this track. In this example, when the envelope is lowered just after the current position of the play cursor, the baseline value of the parameter being modulated will also be lowered.

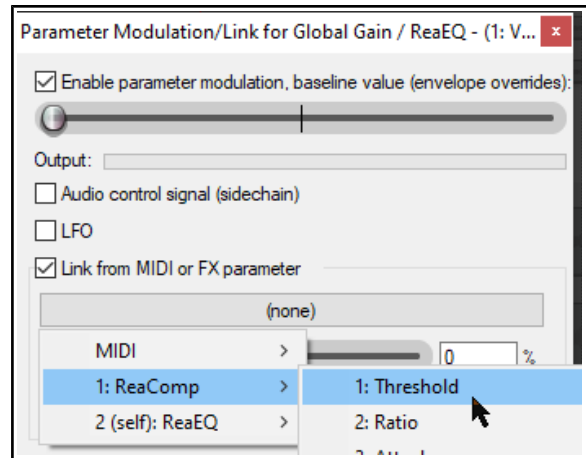

19.11 Parameter Modulation under Sidechain Audio Control

This next example introduces another application for Parameter Modulation. In this case, we will use the audio signal from one track (a vocal track) to shape the sound of an instrument submix (that is, a folder track containing several instruments). This will be done in such a way as to cause the instruments to appear to pull back slightly during the vocal passages.

Example

1. Open the file **All Through The Night MOD1** and save it as **All Through The Night MOD2**.
2. Remove or set to bypass the delay plug-in in the Bouzouki track's FX chain.
3. Insert a new track after the vocal track. Name this track **Instruments** and make it into a folder. Insert the three instrument tracks into this folder, as shown on the right.
4. Add an instance of **ReaComp** to the Bouzouki track. This is needed only because the volume of this instrument increases quite significantly as the song progresses. We wish to pull this back a little.
5. Set a threshold of around -15dB and a ratio of around 4:1.
6. Select the Instruments folder and display its routing window. Set the number of track channels to 4 and add a receive from channels 1/2 of the Vox track to channels 3/4 of the Instruments folder.
7. Open the FX Window for the Instruments folder and add an instance of **JS: Exciter (Treble enhancer)**. This will be used to brighten up the instrument a little.
8. Settings similar to those shown here will definitely brighten the instruments, perhaps more than you would like. For the sake of this exercise, however, these levels should be fine.
9. We are now going to use parameter modulation to ensure that audio signal from the vocal track drives down the mix level of the exciter. This will have the effect of helping the vocal to just float over the instruments a little.
10. Click on the **Mix % (Wet/Dry rotary)** control, then on the **Param** button and choose **Parameter modulation/MIDI link** from the menu.
11. When the PM window is opened, enable parameter modulation and choose **Audio control signal (sidechain)**. Move the baseline value fader about a third of the way to the right.
12. Select **Track audio channels 3/4** and make the direction **Negative**.
13. Adjust the other parameters so that as the vocal floats above the instruments the Mix % of the Exciter is smoothly and gently faded down.
14. One possible solution to this exercise is shown below. But don't just dive straight in and copy these settings. Try to get there by yourself!
15. Save the file when you are finished.

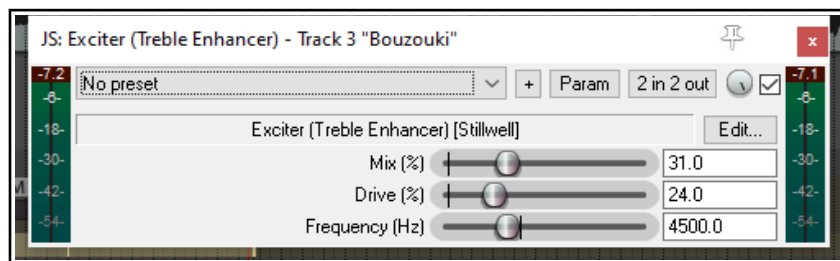

Parameter Modulation and Automation Tips

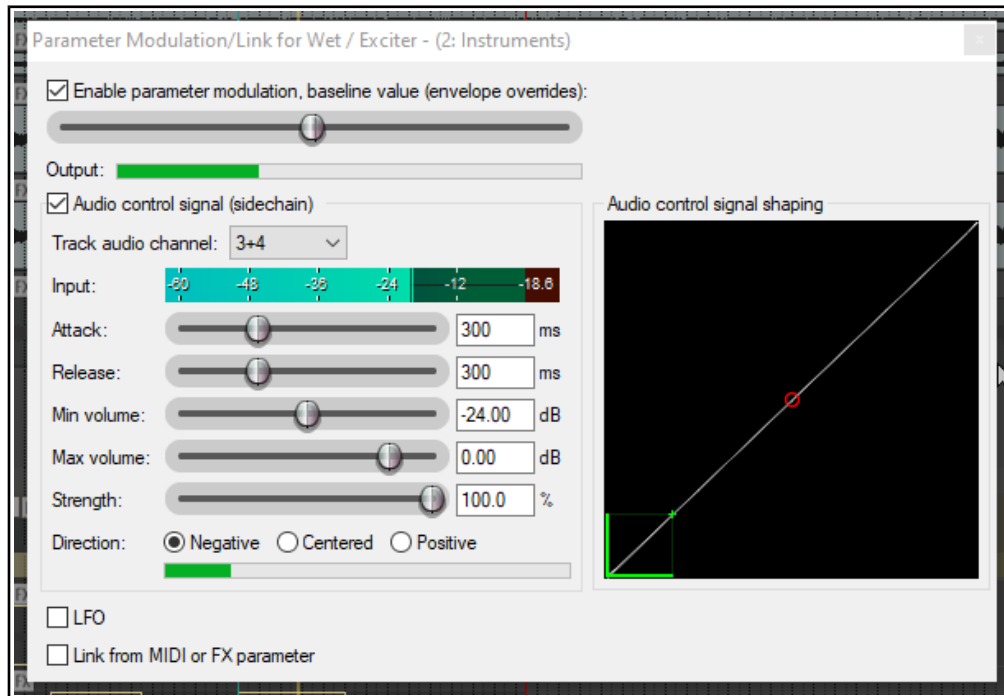

19.12 Using MIDI Links for Parameter Modulation

You can also use MIDI data to control parameter modulation. For example:

- From a ReaControlMIDI parameter, live or recorded as an automation envelope.
- From data/events entered or recorded in a MIDI editor CC lane.

For example, you could use an [automation envelope](#) to record changes in [ReaControlMIDI's](#) volume parameter, then use that envelope to control another FX parameter, such as the ratio setting on a compressor. Another example might be to use a MIDI Editor CC lane to record changes in an instrument's pan position, then adjust the wet/dry mix of an effect such as delay, so as to vary the delay length according to the pan position.

We'll start by looking at these two examples, then you can freely explore any of the many possibilities that are available. For the sake of simplicity, both these examples use DSK Virtuoso. This synth is freeware and very easy to use. If you wish to replicate this example, you can use any synth that you choose.

Example 1: Controlling ReaComp from ReaControlMIDI

1. Create a new project file, add a single track Insert in the track's FX chain first [ReaControlMIDI](#), then a synth of your choice.
2. In arrange view, insert a new MIDI item about 30 seconds long, open the MIDI editor and compose a simple tune. Don't worry about the musicality – just enter enough notes to produce a simple sound.
3. Make whatever changes you wish to the synth parameters, to produce a reasonable sound.
4. Open ReaControlMIDI. Make sure the Control Change section is enabled.
5. Click on the volume control (to make it the last touched item), then click on the **Param** button (top of dialog box) and choose **Show track envelope**.
6. Either record or by manual editing (as you prefer) create an envelope *similar* to that shown below:

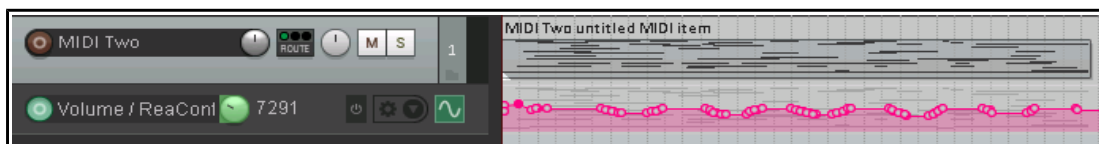

7. At the end of the FX chain, add an instance of **ReaComp**.
8. Play the track. Set ratio to about 4:1 and adjust the threshold to engage the compressor during the louder passages. Return the cursor to the start of the track.
9. Click on the ratio control, then on the **Param** button. From the menu, choose **Parameter modulation/MIDI link**. The dialog shown here will be displayed.
10. Select **Link from MIDI or FX parameter**. Click on the button and from the available options choose **ReaControlMIDI** then **Volume**.
11. The two controls, Offset and Scale have the same purpose as in the examples earlier in this chapter. Carefully adjust the offset control to return the ratio setting on ReaComp to about 4:1.
12. Play the track. Adjust the scale control so as to achieve a gentle movement of the ratio control as the music grows louder and quieter.
13. Save the file as **PMMIDI**. Do not close it.

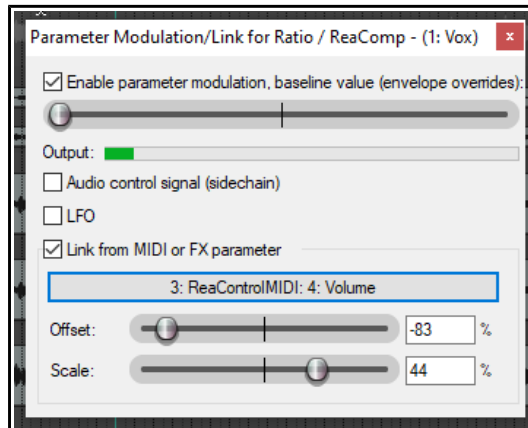

Example 2: Controlling ReaDelay direct from a MIDI CC lane

You could create this example as a separate project or, as we are going to do here, add it to the existing file **PMMIDI**.

14. Open your MIDI item in the MIDI editor. Add a CC lane for **Pan Position MSB** and draw in the necessary events to pan out to the right then back to the center twice or more, as shown here.

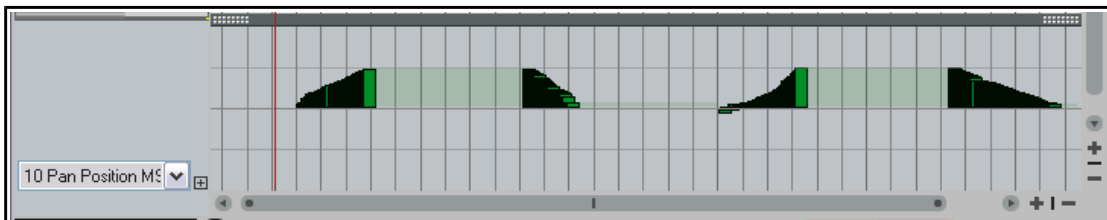

15. In the FX chain, insert **ReaDelay** just before ReaComp. Set length (time) and length (musical) both to 0.0. Set Feedback to about -50.0 dB.
16. Click on the Length (time) control to touch it, then on the **Param** button, then **MIDI link**, then **CC**, then **Pan Position MSB**.

17. The Parameter Modulation/Link dialog will be opened. Click on the large button, then select **MIDI** then **CC** then **Pan position MSB**.
18. Adjust the **Offset** and **Scale** settings so as to get a smooth increase and decrease in the delay length as the pan moves out to the right and back (while the song is played).
19. Save the file!

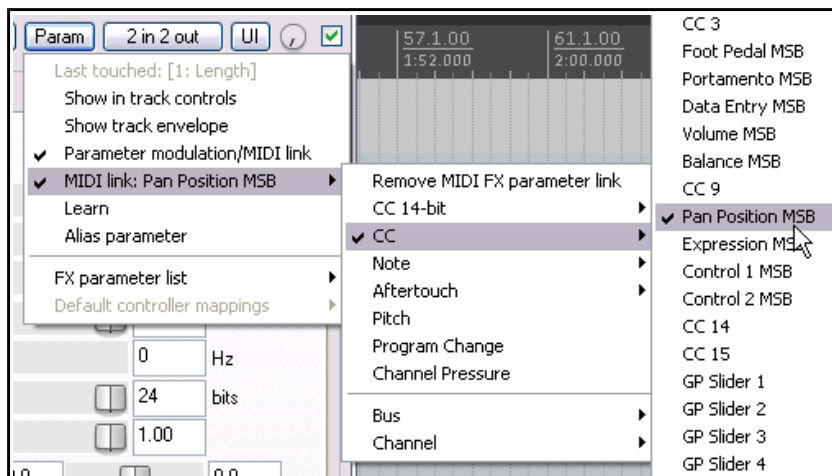

Parameter Modulation and Automation Tips

More about MIDI links

In our two examples, we have built our MIDI links using in one case ReaControlMIDI data, in the other case Midi Editor CC lane events. Let's look at some of the other possibilities.

You would have seen this menu when you were creating your links in the earlier examples:

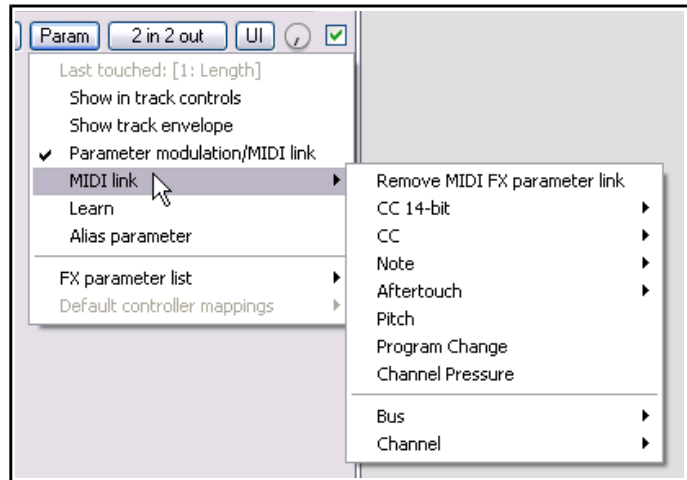

You can link from any of the event types shown on the right.

For CC 14-bit or CC, use the sub menu to specify the event type (this could be any MIDI editor CC lane).

For note or aftertouch, you can select any note.

Other options are pitch, program change or channel pressure.

You can also specify that the parameter modulation is only to be applied to a specified bus or channel.

19.13 Parameter Modulation from Plug-in Parameters

This example uses MIDI buses. It builds on the model presented in **Example 2** (above).

Using REAPER's MIDI Bus architecture you can use parameter modulation to control one instrument's parameters with messages produced by and sent from another. For example, you could use the volume of synth 1 to control, say, the volume of synth 2. Adding an envelope can automate this process.

Synth 2 (in this example) receives its MIDI input on MIDI bus 3. We therefore direct MIDI output from synth 1 to MIDI Bus 3 (see right). You can then select the control on Synth 2 (in this example, volume), click on the Param button and choose Parameter modulation/MIDI link to use

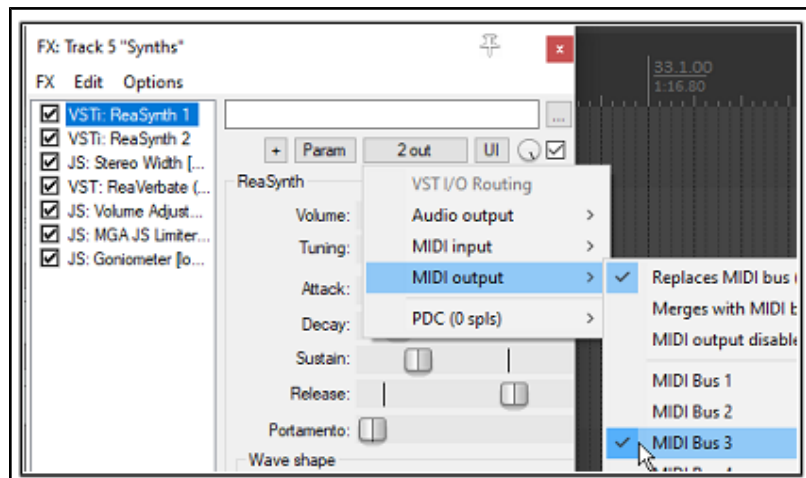

parameter modulation to accept the incoming data from Synth 1 (shown below right). Parameter Modulation (Audio) Audio parameter modulation, of course, is a separate issue from MIDI buses, but it is worth remembering that you can include both types of parameter modulation within a single FX chain.

We can add REAPER's audio routing capabilities into the model. The example above includes ReaVerbate. By sidechaining audio output to additional channels, we use the audio signal on channels 3/4 from one or more synth to control the wet/dry reverb mix.

Alternately, by setting up separate sidechains (3/4, and 5/6) for each synth, you could use the audio streams from the different synths to control different parameters on your various VST plug-ins.

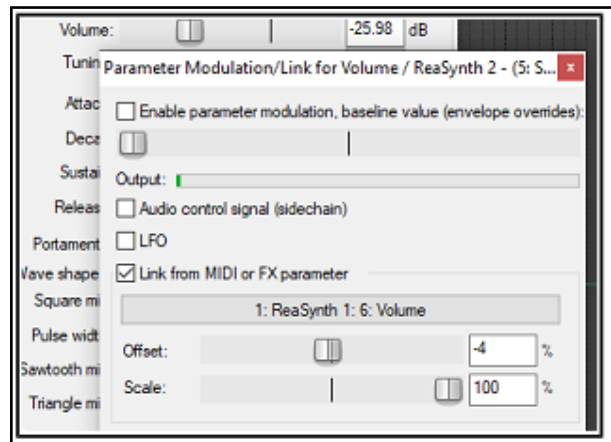

Up and Running: A REAPER User Guide v 7.31

Note: By default, REAPER uses MIDI Bus 1 for routing MIDI data. Whenever you are not presented with a choice of buses (for example, when recording MIDI data) you should assume it is using Bus 1.

You can download a project file with a completed version of this example at:
<https://stash.reaper.fm/v/39866/MIDI%20%20Buses%20Demo.rpp>

19.14 Further Applications

This chapter has introduced you to just a few basic examples to help you understand what REAPER's parameter modulation is and how it can be used. In doing so we have barely scratched the surface.

Here are some other points to keep in mind:

- With parameter modulation, the signal from any track can be used to control parameters on any other. For example, the signal from an audio track can be used to control parameters on a synthesizer, and a synthesizer's output can be used to control signals on an audio track.
- If you are familiar with working with synthesizers and low frequency oscillators, you may have developed an understanding of different types of waveforms such as sine, square and triangle. You can use these LFO shapes in your parameter modulation. The opportunities here can take you well beyond the introductory example used earlier in this section.
- Other applications for parameter modulation are limited only by your needs, your creativity and your imagination. For example, with this technique you are able to use the audio signal from one track (or group of tracks) to control specific parameters on a noise gate on another track (or tracks).

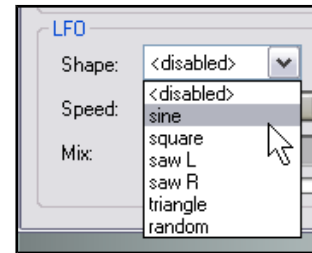

Tip: Your parameter modulation windows and their settings will automatically be saved with any FX chains and/or track templates that you create.

19.15 Managing FX Parameters in the Project Bay

In Chapter 12 you were introduced to the **Project Bay**, including the **FX Bay** which can be used to help you manage and organize your various track, item and master FX.

The Project Bay also includes a **FX Parameters Bay** whose purpose is to assist you in managing the various FX parameter features discussed in this chapter (and elsewhere). From this single interface you can manage track controls, envelopes, parameter modulation and control surface assignment for all parameters for all active track, item take and master track FX.

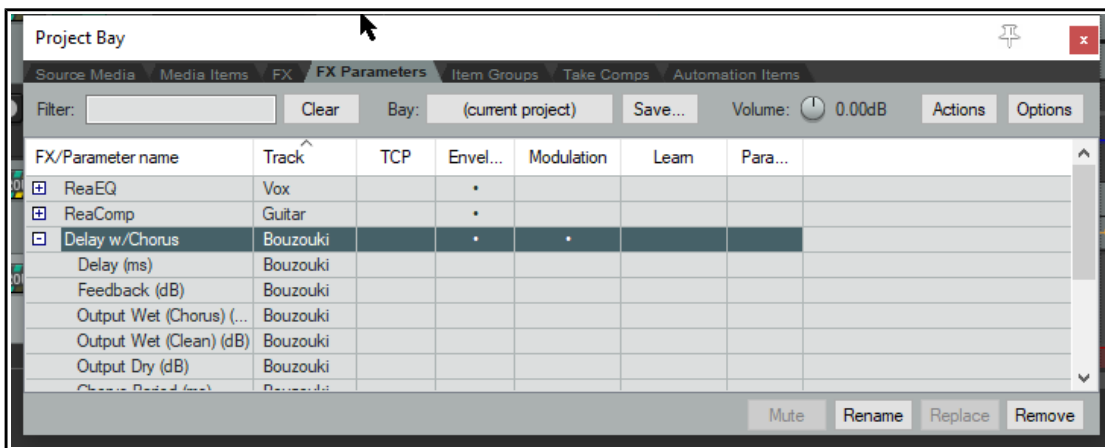

The FX Parameters tab is located next to the FX tab of the Project Bay, displayed by the **View, Project Media/FX** command, and shown right.

This bay supports the standard project bay features explained in Chapter 12, including (where appropriate) the various commands on the **Action** and **Options** button, and from right-click context menus. Here we will focus solely on those aspects that are specific to FX Parameter management.

Parameter Modulation and Automation Tips

Whenever any of these features is added to any FX parameter (e.g. from the individual FX window, or from the FX bay), it will automatically be added to the FX Parameters Bay display. In the above example, Band 2 gain on ReaEQ on track 1 uses parameter modulation: this is shown in the **Mod** column, which also indicates that they are under the control of audio control signals (**ACS**). The Details column tells us that another parameter on this plug-in, Band 4 gain, is linked to Band 2 gain. The **Envelope** column shows that two parameters from ReaDelay on track 5 have armed and active automation envelopes. Two parameters from ReaComp on track 2 have had their controls added to the track control panel (or **TCP**, as indicated by the dots in this column), and one parameter from a Guitar/chorus plug-in (Track 3) has both a track control and an armed envelope. No parameter is shown in the **Learn** column as being under control surface control.

The table below summarises how you the Parameter FX Bay can be used.

In order to do this ...	You do this ...
Manage or modify an existing parameter's settings	Right-click on the FX name and make your choice from the menu. For track FX, these are Show in track controls, add a track envelope, parameter modulation and learn (to assign to a control surface). For item/take FX, the options are track envelope and learn .
Manage or modify a different parameter on the same or another FX	Click on the + sign next to the plug-in name and select a parameter. Right click over it and choose an option (show in track controls, track envelope, parameter modulation or learn) from the sub-menu, then complete the required PM settings.

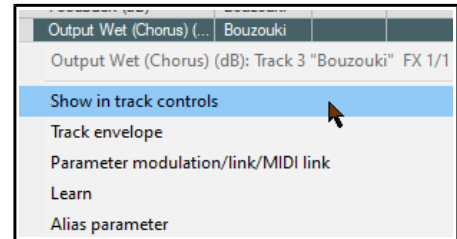

19.16 Automation and Envelope Tips

19.16.1 Changing FX Parameter Envelope Colors

The **Theme Development Tweaker** (Chapter 12) can be used to change the colors used for envelopes.

Open the **Actions List** and run the **Theme tweak/development window** action.

Customised colors can be selected for standard track and item envelopes (such as volume, pan, mute).

In addition, up to four customised colors are available for FX parameter envelopes: these are labelled within the tweaker FX parameter1, FX parameter 2, FX parameter 3 and FX parameter 4.

These colors are applied to your FX parameter envelopes in groups of four. For example, if you automate six FX parameters on a track:

The FX parameter 1 color will be applied to the first and fifth parameter.

The FX parameter 2 color will be applied to the second and sixth parameter.

The FX parameter 3 color will be applied to the third parameter.

The FX parameter 4 color will be applied to the fourth parameter.

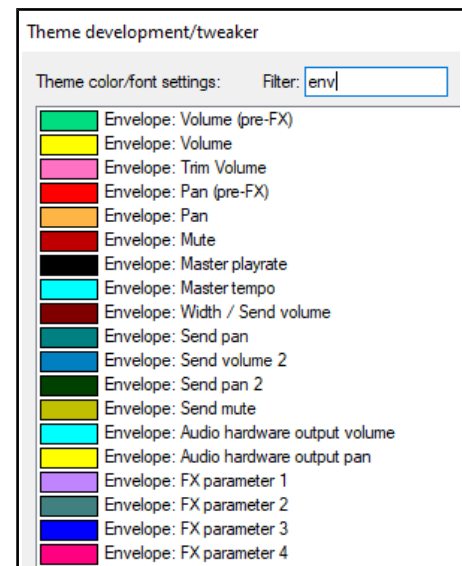

19.16.2 Envelope Color Overrides

Envelope color overrides offer you a greater capability to customise the colors used for your envelopes. To use it to its full extent you will need to understand something about boolean logic, explained in [Chapter 6](#).

To access this feature, choose **Options, Preferences, Appearance, Envelope Colors**.



The number of ways in which this can be used is almost limitless, and everyone will have their own ideas. Here are some example.

To create an override rule, click the **Add** button then create your definition. Here are two simple examples.

You might use a variety of compressors and often need to automate ratio and threshold. You can define a color override so that ratio and threshold envelopes always use your preferred color, regardless of the actual plug-in.

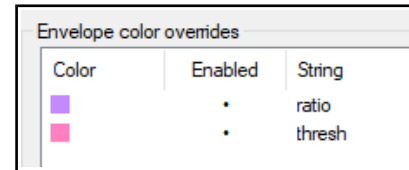
1. Click on the **Add** button. You will be asked to type a name. Type **ratio**, click **OK**.
2. Double click on the color shown, select your color and click **OK**.
3. Click again on **Add**, type **thresh**, click **OK** pick a color as before and click **OK**.
4. For both of these, if Enabled is not selected by default, click in the **Enabled** column to enable them. You should see a mark (as shown on the right).
5. Now add a compressor of your choice to any track and add envelopes for both ratio and threshold. They should conform to your color choices.





Color	Enabled	String
	<input checked="" type="checkbox"/>	ratio
	<input checked="" type="checkbox"/>	thresh

Let's get a bit more clever.

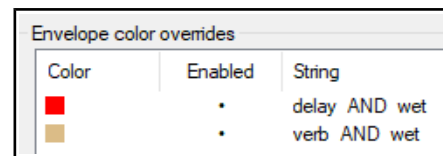
We might use delay and reverb often in our mixes, and also often want to automate the wet parameter. We also want to color code the envelopes so it is visually obvious whether this is a delay envelope or a reverb one. The rules shown here (right) will achieve this. **Note that you will need to type spaces both before and after the AND.**



Color	Enabled	String
	<input checked="" type="checkbox"/>	delay AND wet
	<input checked="" type="checkbox"/>	verb AND wet

Now let's throw a spanner in the works! Suppose your FX library includes a reverb plugin that doesn't have "verb" in its name? Let's call it "SuperDoop." What then? You can edit the rule to allow for this!

We amend the second rule to read:

(Super OR verb) AND wet

Note that a space is required after opening and before closing brackets. Spaces are required before and after the OR and the AND.

You can also use a NOT operator. For example, look at these two rules:

gain AND rea and

gain NOT rea

This would allow you to apply separate color coding to a Gain parameter depending on whether it is one of the Cockos Rea plug-ins or not.

That should give you enough ideas to get you started! The better your understanding of boolean logic, the greater use you will be able to make of this facility.

Note also:

The **Remove** button will remove a currently selected rule from the list.

The **Export** button can be used to export your current overrides to a .EnvColorList file.

The **Import** button can be used to import any previously exported color list file.

Note: If (presumably in error) two or more of your rules contradict each other, then REAPER will apply whichever one is higher up in the list.

Using REAPER with Video

20 Using REAPER with Video

With the introduction of version 5.0, REAPER's video capabilities have been considerably enhanced and expanded. In overview, you can:

- Carry out simple editing tasks like deleting, moving or copying parts of a video.
- Edit an existing video soundtrack.
- Add new sound to a video.
- Add various visual effects to a video track, such as fading and lighting.
- Edit or blend the contents of several video files into one, optionally using effects such as crossfade.
- Use automation envelopes to manage your video effects.
- [Render the output of your project into a new video file.](#)

Throughout this chapter a basic understanding and knowledge of REAPER's audio, editing and project management features is assumed: only those aspects specific to video will be explained in detail. We'll start by looking at and working thru some practical examples, then towards the end of the chapter deal with the more technical aspects such as settings and preferences.

Later in this chapter we'll look at issues like video workflow, but first we'll look at how REAPER handles video.

20.1 Simple Video Editing

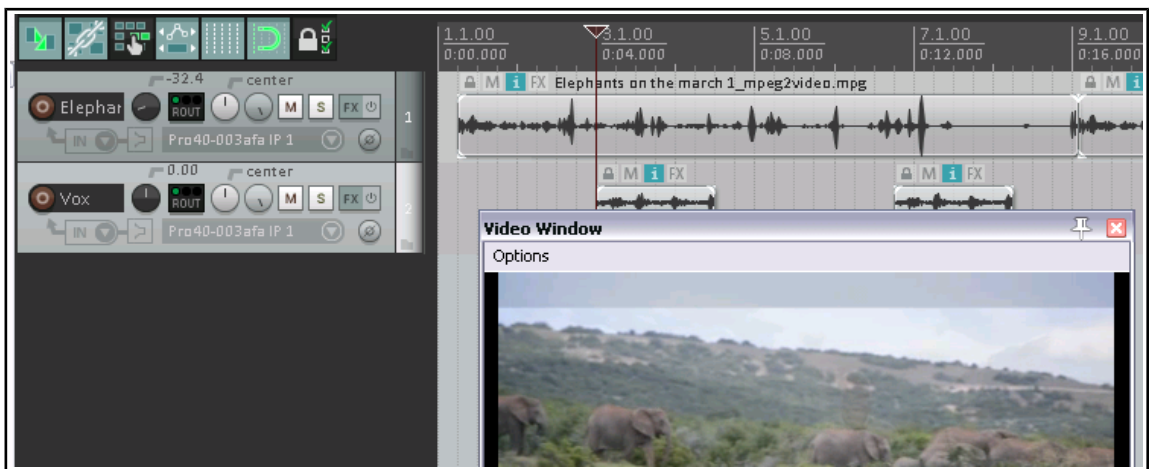

REAPER can be used to edit the soundtrack of your video files, such as .MOV, .WEBM, .AVI, .MPG, .VLC, .MP4 and .WMV files. These files are imported via the **Insert, Media File** command, or by dragging and dropping into the Arrange window.

You can use the **Track, Insert Track from Template** command to import data from a .EDL file. Use the **View, Video Window** command, **Ctrl Shift V**, to show the video window (which is dockable). For Windows users, video playback is handled by Direct Show (but see [20.7](#)): MacOS uses Quick Time.

You can edit the original soundtrack, and/or add extra audio tracks and items to the existing soundtrack (as shown above).

The **Options** menu in the video window (shown right) offers a number of useful features, including:

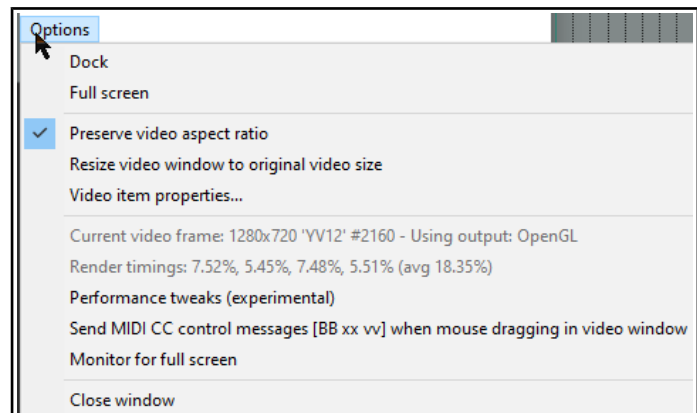

Dock: This option enables you to dock the video window. The same command will also undock an existing docked window. Docking is discussed throughout this user guide. In particular, [simple docking](#) is explained more fully in Chapter 2, and the use of [multiple dockers](#) is explored in Chapter 12.

Up and Running: A REAPER User Guide v 7.31

Full screen: A toggle command used to expand the video window to cover the whole screen. In full screen mode, right click anywhere to display this menu.

Preserve video aspect ratio: When enabled, this ensures that the height:width picture ratio is maintained no matter how the window is resized.

Resize video window to original video size: Needs no explanation!

Video item properties. This opens a window revealing the properties (length, video, audio, decoding format, etc.) of the video item.

Example 1

Download the sample file **VideoSamples.zip** from: <https://dlz.reaper.fm/userguide/VideoExamples.zip>

To open this, you may need to have a utility program such as **AIZip** or **7 Zip**. The archive file contains two folders, **Wildlife** and **Zebras**. The video items are in MOV format. If they do not display in REAPER, you may need to install the VLC decoder. An easy way to do this is simply to download and install the free [VLC media player](#) (see also [Section 20.7](#)). In the sample clips, video quality has been compromised to keep the file and download size to a minimum.

In the first example we will start by performing some basic and simple editing tasks before getting a little more ambitious and adding some effects. *You should not attempt these exercises unless you have at least a basic understanding and experience of working within REAPER's arrange view environment.*

1. Open the project **Zebras.RPP**. You will find a video of about 45 seconds of zebras drinking at a water hole. Let's decide we want to shorten it a little. First, save it as **ZebrasDemo.RPP**.
2. Display the **Options** menu and make sure that **Ripple editing** is enabled for all tracks.
3. Click on the media item **Zebras.mov** to select it.
4. Within the arrange view window, select the time from approx 8 to 20 secs. Right click on the media item and choose **Cut selected area of item**. Press **Esc** to clear the time selection. Turn ripple editing off.
5. Now let's add a musical soundtrack. Turn the volume fader on the **Zebras** track all the way down.
6. Display Windows Explorer and from the **Zebras** folder drag and drop the file **morning.mp3** into your project as a new track. Shorten this track to make it the same length as the video. Save and play the file
7. If you wish, add a track to this project. On this track record a little spoken commentary, then use volume envelopes so that the voice will sit nicely on top of the music. Your project will look something like this:

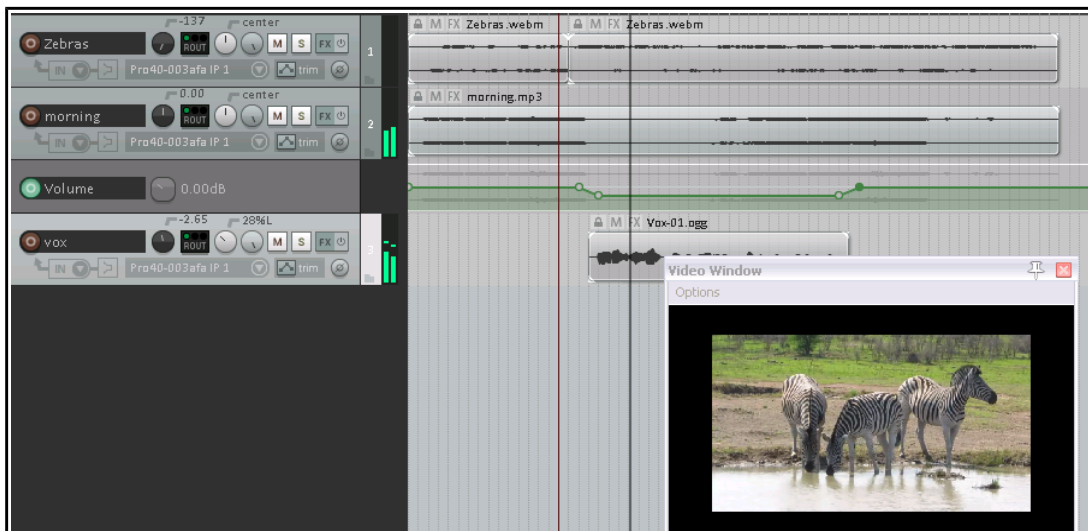

8. Save the file. Do not yet close it. We are going to add a video effect or two.

REAPER's video effects can be inserted into track or item take FX chains. They are flexible and powerful, but they do take some time and effort to get to grips with and to master. Some of them do include parameter control rotaries, but sometimes to get the best results you will need to be a little more adventurous. We'll dig deeper into explanations later in this chapter, but for now let's just explore some of the simpler options.

Using REAPER with Video

20.2 Video Effects

Example 1 (Continued)

- Click on the **FX** button for the video track **Zebras**. When the **Add FX** window is displayed, make sure that **All Plugins** is selected in the left pane. In the right pane click on **Video processor** then **OK**. Instead of a window with a standard familiar plug-in interface you will see something quite different. Currently no effect has yet been loaded.

- Let's add a title. From the presets drop down list choose

Overlay: Text.

This might look a bit strange (see right).

- The first black column displays the parameter controls. These determine the size, appearance and position of the text.

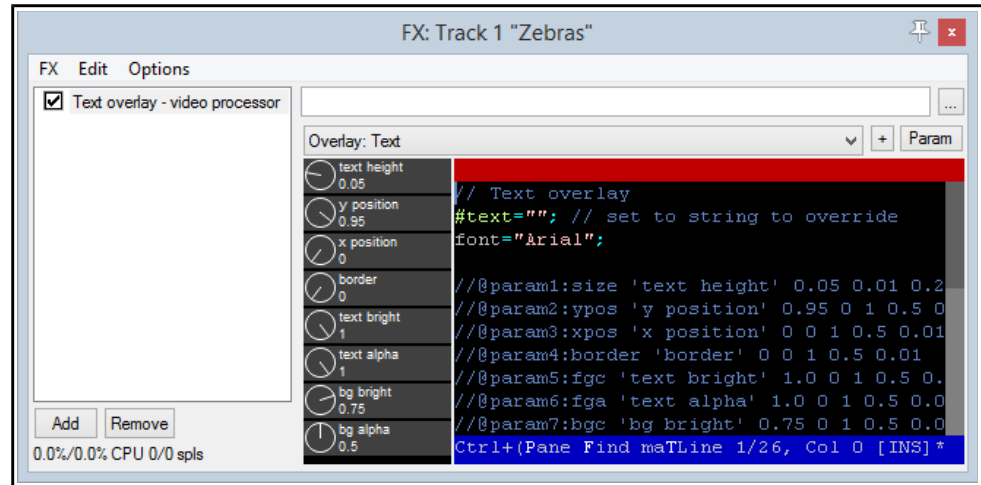

- The second column contains the actual EEL code used to create the effect. Notice that your video window currently displays the message **#text=""**. Click in this pane and edit this line to read **Text="Zebras"**; (edit only the text between the quote marks, nothing else), then press **Ctrl S** to save. The text in your video window changes.

- Let's create some effects. Click first on this FX's **text height** parameter control button, then on the **Param** button (top right), then **Show track envelope**. Add points and adjust this envelope as shown here.

- With your mouse adjust the **y position** knob to approx **0.07**. Play the video. The text will now appear higher up, starting very small and growing larger. Setting **text bright** to 0 will make the text more clearly visible

- Let's suppose we only want to display the title for 10 seconds or so. This can be achieved by adding a bypass envelope. Click on the automation button for the Zebras video track (labelled "trim"). Under the heading **text overlay** select **Bypass**. Close the window: a bypass envelope will be displayed just beneath the track.



- At or around the 10 second mark, add a point to this envelope and drag that point up, as shown below:

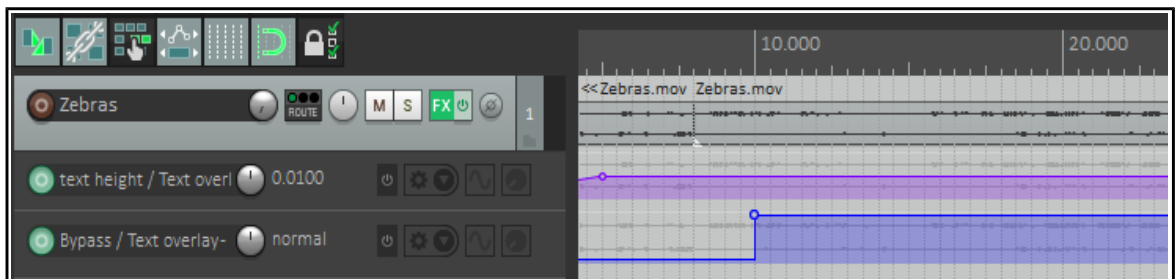

- Save the file and play the video.

- Now let's add a visual effect. In the FX chain for the Zebras video track, add a second instance of the **video processor**.

19. Into this effect load the preset **Transition: horizontal wipe**. This preset includes the parameter control, labelled **wipe pos**.
20. Save the file and play it. Notice you can now only see half of the picture in the video window: the other half is blackened out!
21. We can fix this with an automation envelope. Add and envelope for this track for the parameter **wipe pos** on the horizontal wipe effect.
22. Adjust this envelope as shown below: you do not need to be exact in positioning the points.

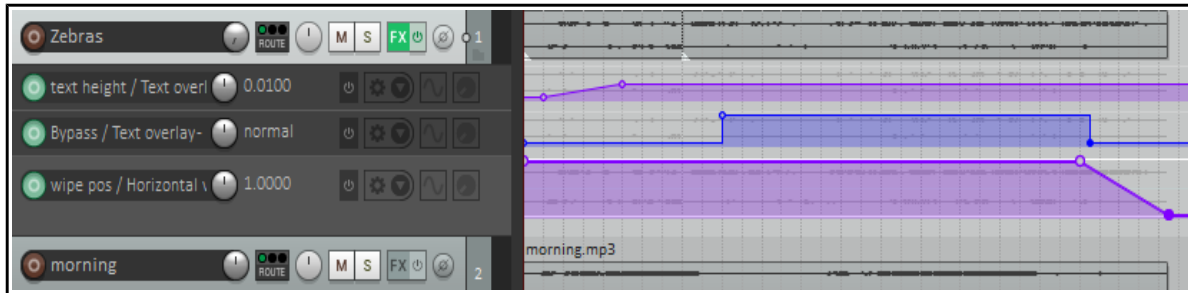

23. Save the file and play the video. The picture will now scroll out from the right at the end of the video. In the next example we will be a little more ambitious with our use of effects.

Note 1: When you modify and the code of a video effect, you are only changing it for that single instance, you are not changing the default. If you make a mistake or get confused, simply remove the plug-in from the FX chain, reinsert it and start again.

Note 2: Pressing **F1** from within a preset code window will open a help window which includes a list of parameters used by that preset,.

20.3 Working with Multiple Video Tracks

There is one important fact that you will need to get your head around before you start working on projects with more than one video track. *Unlike pure audio projects, when you are working with multiple video tracks the track order is significant.*

REAPER processes video tracks and items differently from the way in which it processes audio tracks and items. By default, REAPER will audibly process all audio tracks and items. With video, however, the situation is different, not least because you may have several video tracks all competing for the one video window. The *default* position is that where multiple video tracks are present, during playback only the item(s) on one of them will be displayed in the video window. Which one this is will depend on which is assigned the highest priority.

The following summary indicates how priority is allocated. However, be assured (as you will see in the examples later in this section) that by using transition effects and automation envelopes you can override the default behavior and determine which and/or how many of your items are displayed at any one time during playback.

- ◆ Video is by default processed from bottom to top, so that a lower numbered track will override a higher numbered track. For example, if track 1 and track 2 both contain video items, then without the use of envelopes and/or effects only the video contents of track 1 will be displayed in the video window during playback. The master track is processed last.
- ◆ A similar hierarchy exists on tracks with more than one video item and where free item positioning is used. That is, by default the contents of only the bottommost item will be displayed in the video window.
- ◆ Where video FX are used, video FX on the track process the output of the video FX on individual items.

There is an option on the Video page of your Project Settings which allows you to reverse the video processing hierarchy if you wish, so that video will be processed instead from top to bottom.

Working with video files can be a resource hungry activity, especially on older computers. If you are encountering performance difficulties during playback and/or editing, you may need to make tweaks to your [video preferences options](#) which can improve performance. These are explained at the end of this chapter.

Video effects can be inserted in any of three places – in the video item itself, in the video track, or in a separate video effects track. Depending on where you place them, the outcome can vary. If necessary, be patient, and be prepared to learn by exploring!

Using REAPER with Video

This next example uses a project file with three video tracks. If you have downloaded and unzipped the sample files included in **VideoSamples.zip** you will find the folder **Wildlife**, which includes two projects, **Wildlife1** and **Wildlife2**. Wildlife1 will be used for the practical exercises. Wildlife2 shows you the project with the exercises completed, plus a few extra effects that we'll get to later. A third file, **Wildlife 3** also has some extra effects.

Example 2

First, we will look at a project with some simple edits and video effects added. After that, we can discover how this was done. Open the file **Wildlife2** and play the video from the beginning. Notice in particular that:

- If you check the video page of your project settings (**Alt Enter**) you should see that **Items in lower numbered tracks replace higher** is selected..
- There is a scrolling title.
- There are three video tracks, which have been edited so that at the beginning and end of the movie these are shown one at a time, in sequence, but in between they are faded in and out.
- An additional track, Track 1, contains no media items, only various video processing plug-ins.
- Further visual effects are used from time to time..
- Let's see how this was done, starting with track 1, Video FX.

The Track Edits

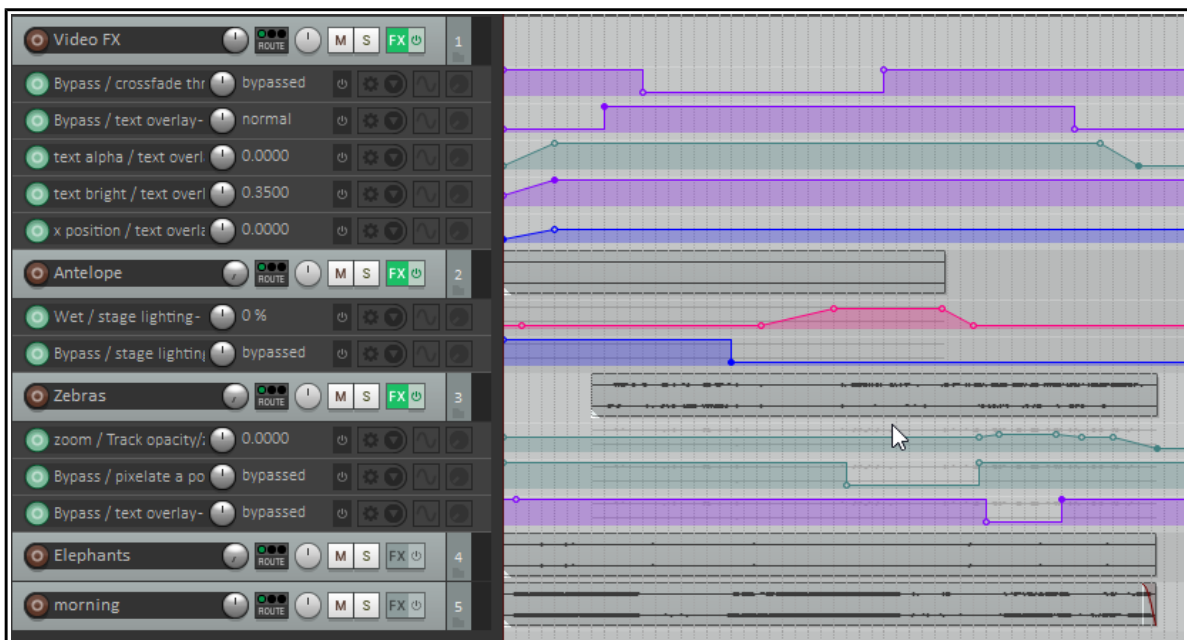

Simple slip editing has been performed on the video tracks. Because these are processed with lower track numbers having priority, when this is played you will initially see only the elephants (track 4), then only the zebras (track 3) then only the antelopes (track 2). A number of envelopes have been added. In these examples, the FX have been applied in each case to the entire track. Keep in mind, however, that you can apply these effects directly to individual items if you wish. Explanations follow!

The Title

Position the play cursor at the very start of the video. A video processing effect instance has been added to this track's FX chain (track 1), and the preset **Overlay:text** selected. The code has been edited with the text changed to **Morning in Africa**

Some parameter values have been changed from their defaults, notably **text height** (0.1), **y position** (.49) and **text bright** (0.35). This last setting hides the text by making it the same color as its background.

Envelopes have been added (see above) to first fade up the text to make it visible (**text bright**), then scroll it across the screen to the center (**x pos**), then fade it out. A **bypass** envelope ensures that the title is removed altogether at or around the 8 second mark.

Tips: To help you understand how the video processor works, at any time you can click in the window containing the preset code and press **F1** to obtain further information (right).

If you wish, you can edit parameter values directly in the code. The next example does this.

The Crossfade Effect

A further video processor instance has been added (above the text overlay) to Track 1, using the **Combine: crossfade through inputs...** preset.

A **bypass** envelope is used to ensure that the crossfade is applied only during the period of approximately 20 seconds in the middle of the movie.

The speed of the crossfade is determined by the multiplier used to set value of the parameter **project_time**. The higher this value, the faster the rate of crossfade. In this example, this has been edited from its default value of 0.5 to 0.2 (see below right)

Notice that the order in which your FX are applied is significant. In this case, the crossfade appears in the FX chain *before* the text overlay.

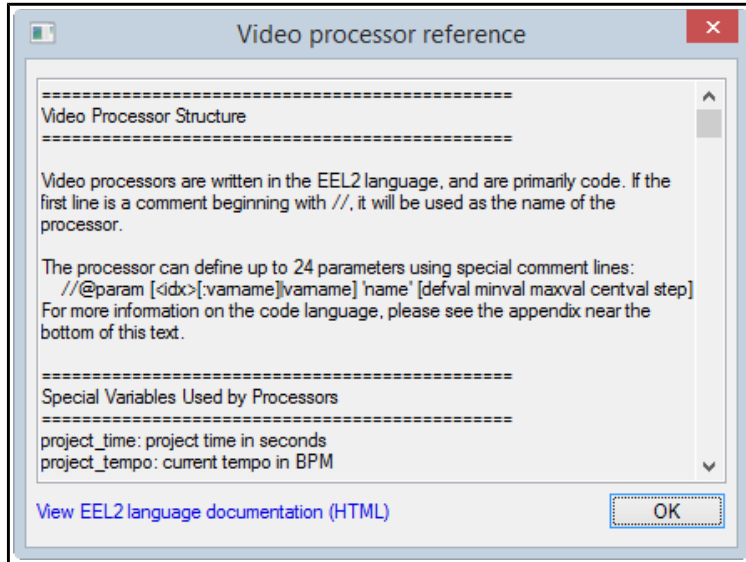

```
// crossfade through other tracks
parm = project_time*0.2; // cycle speed
skip_inputs = 0;
skip_trailing_inputs = 0;
```

The Zoom Effect

An instance of the video processor plug-in has been added to the **Zebra**s track and the preset **Basic helpers: track opacity/zoom/pan** added. A zoom envelope is used to zoom this track first close in to the zebras, then right out at the very end. out completely at the very end.

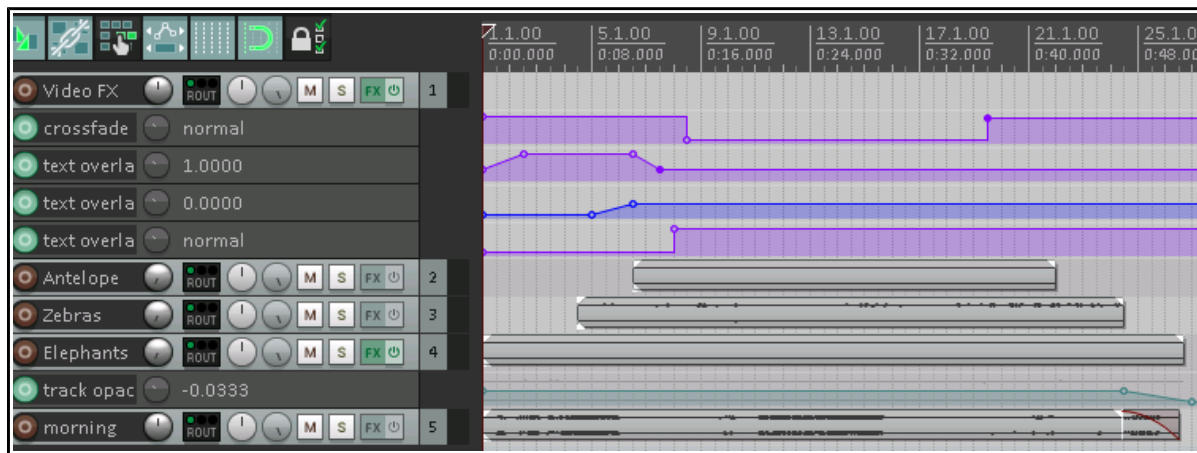

Note: If you develop a serious knowledge and understanding of scripting languages such as Lua or EEL then you have at your disposal an amazing scope for creating and using video effects in REAPER. However, as this example has demonstrated, even a very limited knowledge and understanding such as is required for this example places considerable power in your hands!

Try it yourself! Open the file **Wildlife1**, save it as **Wildlife1a** and have a go at reproducing these effects yourself. Any time you make edits to any code, remember to press **Ctrl S** to save. If you have more time on your hands, see what other effects you can find in this file that have not been described in this example! Don't yet be too ambitious: in the next example we'll explore a slightly more complicated example.

Using REAPER with Video

Example 3

This next example, **Wildlife3** uses the same source media files but includes some extra effects and more automation envelopes. Play this video from the beginning, then we can have a look at what has been added.

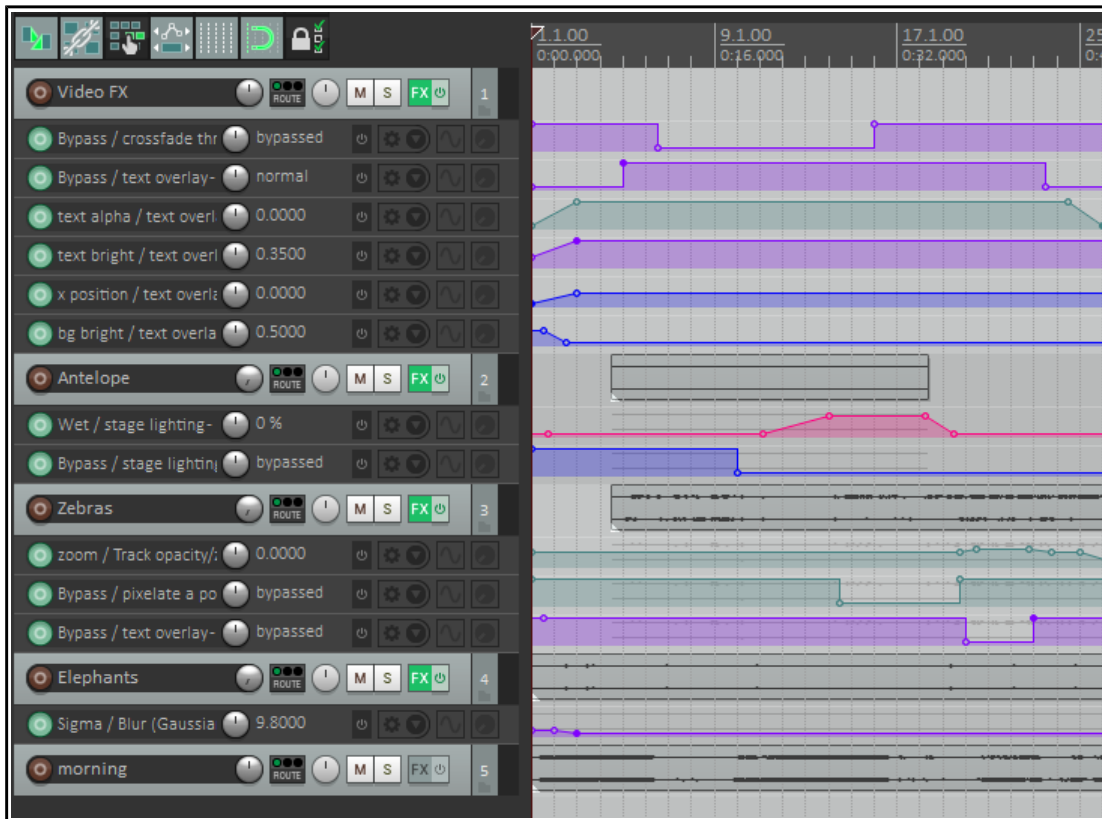

- The main title is centered on the video window, is larger, and fades up at the beginning before disappearing. It reappears near the end and is faded down.
- There are more effects on the antelopes. They return at about the 10 second mark badly pixelated, then gradually ease into a clean image before the lighting effect is applied.
- The zebras have their own track title displayed, Time for a drink. This is displayed for a few seconds near the end of the video. Let's see how this was ALL done.

The Main Title: An envelope has been added for **bg bright**, starting at .5 and fading down to 0, so that the background will now fade in with the text. The **y position** of the text overlayed has been lowered.

The Antelope Stage Lighting Effect: A stage lighting effect has been added to the Antelope video track. Conservative values have been applied to the parameters to ensure that the effect is fairly subtle.

The Zebra Pixel Effect: An instance of the video processor has been added to the Zebra track FX chain, and the preset

FX:pixelate image has been added. This preset comes with five parameter controls (knobs), any or all of which can be tweaked and/or automated.

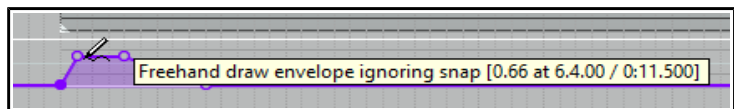

Together, the first four determine the positioning (horizontal and vertical) and size (width and height) of the area covered by, the pixelated part of the screen. Experiment with these if you like. The fifth control determines the size of each pixel: this is what we are going to look at now.

A **pixelsize** and a **bypass** envelope have both been added for this plug-in. The bypass envelope ensures that the pixel effect is only displayed for the few seconds that it requires. The **pixelsize** starts at zero, rises sharply to about 50%, then gradually decreases again to zero.

Up and Running: A REAPER User Guide v 7.31

A **gaussian blur** effect has been added to the **Elephants**, so that the elephant herd gradually comes into focus at the start of the video.

Multi File Projects

You might need to work on audio material in one .RPP file which relates to video material in another. In that case, just make sure that you have the necessary file open (obviously on separate project tabs). You can then right click on any project tab and choose the option **Display video from background projects if active project lacks video**.

20.4 Video Processor Parameter Controls

The video processor plug-in includes the standard features of REAPER's audio plug-ins, explained in [Chapter 6](#) of this User Guide. For example, the **+** button can be used to save and load your own **presets**.

From a track's FX chain, click first on any of the plug-in's parameter controls then on the plug-in's **Param** button then choose **Show in track controls**, **Show track envelope**, use [Parameter modulation/MIDI link](#) or **Learn** (to assign the control to a controller). From an item's FX chain, you can add an automation envelope or access the learn function.

20.5 Supplied Video Effects Presets

These examples have introduced you to just a handful of the video presets that are available in REAPER. Each has its own purpose, but all are capable of being edited and can be automated. They are arranged into a number of categories, according to their purpose. Below is a summary of supplied presets.

In many cases, their purpose is self evident from it's name (e.g. Basic helpers: Brightness/Contrast, Combine: Crossfade thru inputs, FX: Colorize, Transition: Horizontal wipe). In other cases, the terminology of the video world might be less obvious to the uninitiated (e.g. blur, YUV). One way to learn is by experimenting. A glossary of video terms such as is found here can be helpful.

https://www.manifest-tech.com/links/video_terms.htm . Remember that you can always jump on to the REAPER forum if you need more help.

Analysis

- Color Peeker (Monitoring FX only)
- Histogram (RGB)

Basic helpers

- Apply track FX only where track has video items
- Brightness/Contrast
- De-interlace track/item
- Decimate track/item frame rate
- Item fades affect video
- Resize track/item to project dimensions
- Track opacity/zoom/pan

Combine

- 2 x 2 input matrix
- Chroma-key (RGB version)
- Chroma key (YUV version)
- Crossfade through inputs

FX

- Blitter feedback
- Blur (Gaussian)
- Blur (low quality)
- Colorize
- Edge detection (vertical)
- Invert colors

FX (cont)

- Matrix of recent frames
- Pixelate image
- RGB decompose
- Shadow/midtone/highlight RGB adjust
- Show motion (subtract last frame)
- Stage lighting

Overlay

- Image overlay
- Text

Panoramic

- Equirectangular/spherical 360 panner
- Spherical 360 to stacked panoramic slices

Synthesis

- Decorative Oscilloscope with Blitter
- Decorative Spectrum Analyzer

Transition

- Horizontal wipe
- Matrix wipe
- Peephole wipe/vignette
- Vertical wipe

Utility

- Screensaver (Monitoring FX only)

Note also that from time to time more presets are added to REAPER's video processor plug-in.

Using REAPER with Video

20.6 Understanding Video Formats

Newcomers to video often find the whole topic bewildering. This section aims to guide you thru some basic concepts, so that you can at least confidently get started. It is not comprehensive and by no means covers everything that you should eventually need to know.

Video files hold video and other data that exhibits a number of *attributes* such as frame rate, pixel dimensions and audio channels. Different *formats* can be used for capturing, saving, editing and distribution of this data. Different formats are characterised by the whichever *video container* and *codec* they use.

Video signal attributes

As with most things audio and video, the higher the numbers the better the quality and the larger the resulting file size! In particular, video characteristics include:

- **Frame size:** the video frame's dimensions, measured in pixels, typically within the range 160 (width) by 120 (height) to 1920 by 1080 (Full HD).
- **Frame rate:** the speed with which each frame is first captured then played back. Each frame holds a still image. The human eye starts to see motion (albeit "jerky") at 8 frames per second (fps). The motion will start to appear smooth at rates of 24 fps and above. The U.S. standard frame rate for 720 HD (1280 by 720 pixels) is 59.94 fps, often rounded up to 60 fps
- **Aspect ratio:** the ratio of width to height. This can be expressed either as whole numbers, e.g. 16 by 9, or as a decimal ratio, e.g. 1.78:1. 16 by 9 is the ratio used by widescreen TV.
- **Bit rate:** the data transfer rate, i.e. from the file to the screen. Bit rate is usually measured in megabits per second (mps). By way of example, HD Blu-ray video typically uses a bit rate of 20 mbps, standard DVD quality is around 6 mbps. HD mobile phone, on the other hand uses rates of 2500 (HD) or 5000 (Full HD) *kilobits* per second (kbps).
- **Audio sample rate:** the number of samples per second used to digitize recorded sound. This is discussed in [Chapter 2](#) and [Chapter 3](#).

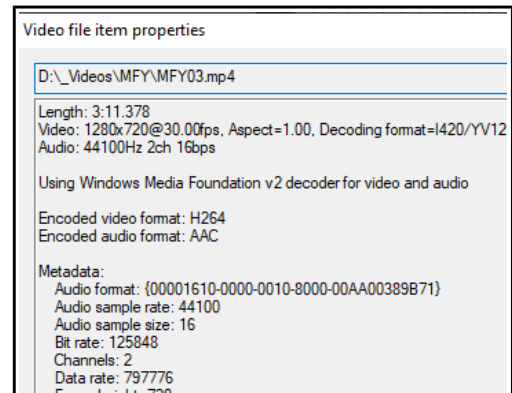

Container files

Container files are files that contain video (and other related) data. You are probably at least vaguely familiar with commonly used container extensions such as .MOV, and AVI. Different containers provide different degrees of support for (for

examples) different video and audio compression formats, subtitles, and so on. For example, several container formats support multiple audio streams, others support only one. In fact, you can learn very little about a video file from its container type alone. To do that, right-click over the video item within REAPER and choose **Video Item Properties...** from the context menu. An example is shown above.

When [rendering video](#) in REAPER (see Chapter 21) available formats are AVI, QT/MOV/MP4, MKV and WEBM.

Codecs

If the container format provides a container for holding a file's data, then the codec (coder/decoder) is the method by which that data is actually encoded. The very large number of codecs available makes this whole topic something of a minefield. Important characteristics of codecs include their video quality, performance factors (such as compression/decompression speed, supported profiles, options, supported resolution, and so on). Some codecs are available free of charge, others you have to pay for. Because raw video files are so large, file size compression is one of the most important aspect of video codecs. Indeed, most consumer standard recording equipment captures video in the first place in compressed rather than raw video format.

When rendering in REAPER, your choice of codec will largely depend on which container format is selected.

Note: For more technical information, see: <https://forum.cockos.com/showthread.php?t=82459>

20.7 REAPER Video Processing Tips

1. For Windows users, if a video file won't play in REAPER, the chances are that you do not have a codec (coder/decoder) required for that video format. Codecs are freely available on the internet. Download and install the VLC decoder from <http://download.videolan.org/pub/videolan/vlc/> Navigate down to the latest number (at time of writing 3.0.9.2) and select it. Choose win32 or win 64 (depending on your system), then

Up and Running: A REAPER User Guide v 7.31

download and install the required .exe file. This will also install the codecs required for AVI, MKV, MP4, WMV, MPEG-1, MPEG-2, DIVX and many other video formats. Moreover, video playback will now be handled by VLC rather than Direct Show.

2. The Media, Video/Rex/Misc page of your Preferences includes an option for you to specify your own video decoder priorities. If you get into trouble here, there is an option to **Reset to defaults**.

20.8 REAPER Video Settings and Preferences

Pressing **Alt Enter** displays the project settings dialog. Select the **Video** tab.

You can select a **frame rate** from the drop down list, or type in your own value.

Optionally, you may enter a **preferred video size** if you wish. If this is left blank, the video will try to size to the active media being played. If your project has videos all recorded at the same dimensions, setting this is unnecessary. If you have various videos at different resolutions, it can be advantageous to specify a size here. If you provide only a width or a height, it will adjust the other value to put things at a default 16:9 ratio.

Video item visibility determines the order in which video items are processed. **Items in lower numbered tracks replace higher** is consistent with the approach taken by most video editing programs, but you can select **Items in higher numbered tracks replace lower** if you wish.

Options for **video colorspace** are auto, 1420/YV12, YUY2 or RGB. Both YUY2 and 1420/YV12 store data more efficiently than RGB and offer an almost lossless form of file compression (but see comments below).

The **Video processor automation** determines whether automation is to be evaluated at the start of the frame or in the middle of the frame.

There are also options to allow you to choose whether or not video is to be affected by **Solo state of other tracks** and/or **Muted parent tracks**.

Video colorspace options are **Auto**, **1420/YV12**, **YUY2** or **RGB**. **Auto** will ensure that whatever colorspace the media natively decodes will be used. Usually this is YV12.

YV12 is the output mode used by most modern codecs (such as h264, or MPEG-4, or MPEG-2, or WEBM), and is usually the fastest because it can avoid colorspace conversions.

YUY2 is similar to YV12 but is less-often used, and offers a little bit better color resolution (due to using less subsampling for luminance and chroma). Converting from YV12 to YUY2 is relatively inexpensive. YV12 and YUY2 are both YUV standards.

RGBA is a completely different mode that matches the pixels on your screen. It is expensive to convert from YV12 or YUY2 to RGBA, and processing video frames in RGBA is also slower. Using RGBA also causes the chromakeyed blit functions (such as the chroma-key preset) to use a different algorithm, so it will look different. In fact, things will generally look slightly different in RGBA mode.

Other settings are toggles for the options **Always resize video sources to preferred video size**, **Always resize output to preferred video size**, **Use high quality filtering when resizing**, and **Preserve aspect ratio (letterbox) when resizing**.

The option to **Always resize video to preferred video size**, if selected, will always resize the video if necessary prior to any processing. This can simplify use of certain FX, but also can be less efficient (since other FX can handle the resize natively as part of their own processing).

The option to **Always resize output to preferred video size**, if selected, forces a resize if necessary at the output stage (meaning processing may happen at some other resolution, but at the end it is resized to the specified size for display). When rendering to a file, this option is effectively selected, with the preferred width/height set to the rendering width/height output.

Shown below is the **Options, Preferences, Media, Video** window.

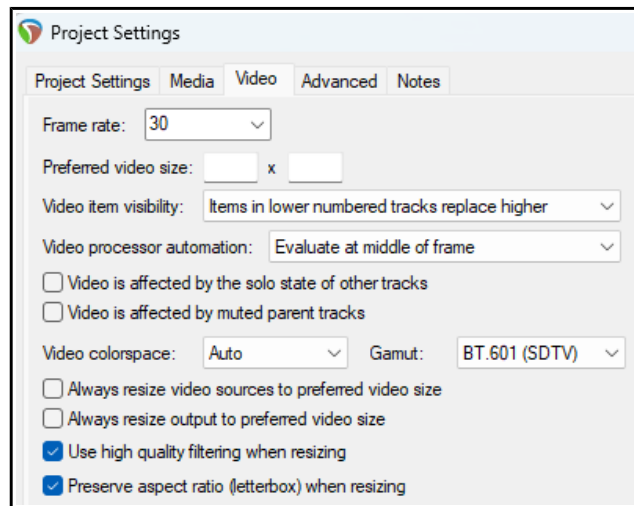

Using REAPER with Video

Output options are shown below that.

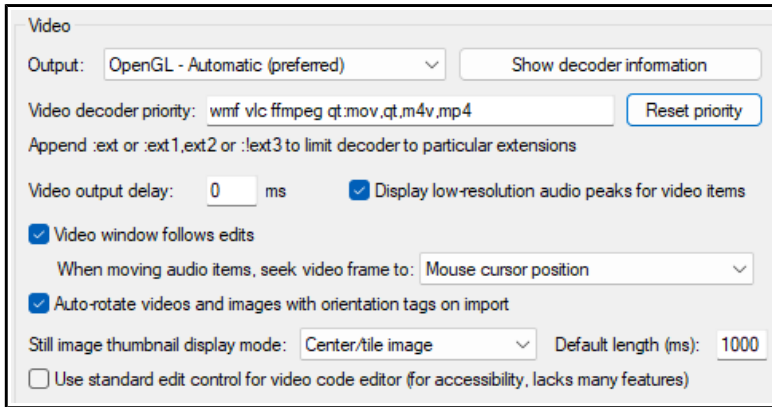

There is an option to open a window within Preferences to **Show decoder** information. You can, if you wish, edit the **Video decoder priority list** to change the order in which priority is allocated. By default, VLC format is assigned the highest priority.

The option to specify **Video output delay** can be used if necessary to improve playback synchronization. This can be a small positive or negative amount. There is also an option to **disable high-resolution peaks**. Enabling the option **Video window**

follows edits will synch the video window to the seek point when audio items are moved or resized.

Still image thumbnails can be hidden or displayed in center/tile mode, full height mode or stretch/image mode. You can also specify the **default length** for thumbnail images.

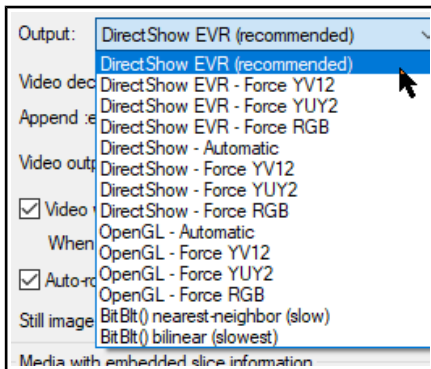

There is also an option to **use standard (accessible) OS editing control for video code**.

You can further choose your preferred behavior when audio items are moved, so that the video window displays content at the mouse cursor position, the start of the audio item, or a snap offset of the audio item.

Note also an option to **Auto-rotate videos and images with orientation tags on import**.⁴

The **Video file item properties** dialog (accessed by choosing **Source properties** from the item context menu) includes options to **Ignore audio** and for handling **Hi-res peaks**. There is also an option to **Copy audio settings to all video sources**.

In addition, the **File, Render** command can be used to export video from REAPER - see [Chapter 21](#).

Note also that the **Performance meter** includes an option to **Display video load**.

Video actions

REAPER's Actions List includes two actions specifically relevant to video. Remember that if you wish you can assign your own keyboard shortcuts and/or toolbar icons for either or both of these:

- Video: Show/hide video window (*by default* **Ctrl Shift V**)
- Video: Clear video cache/re-render frames

20.9 Video Workflow Tips

If you are new to video editing, you might find the following tips helpful. They make reference to many of REAPER's tools and features (such as media explorer, screensets, track manager, markers and regions) that are explained elsewhere in this user guide.

Of course, these tips are general. Whilst they are intended to help you, you will most likely also have considerations specific to your own needs and workflow that might not be mentioned here, or that might make aspects of this model less suitable for you.

1. Video files require large amounts of disk space. However, even if you are intending to distribute your work over the internet, perhaps via YouTube, you should record and edit your material (video and audio) in high quality, then use lossless codecs to convert your files for distribution. A number of freeware programs are available for this, such as MediaCoder, Quick Media Converter and Super Video Converter.
2. Before you start editing, organize all your material. This might be scattered across various SD cards, hard disks, USB sticks, or whatever.
Copy all your source materials into one place on the hard disk of the computer on which you use REAPER. Create a folder for the project, and various sub-folders for your media, such as videos, audio music, audio spoken, and so on. If necessary rename your various source files to make them more easily identifiable

Up and Running: A REAPER User Guide v 7.31

and so as to present them in a logical order. Make sure that after *every* editing session you back this folder up to at least two different destinations.

3. Create your project file in REAPER. Check your project settings, especially the video settings. Specify your required timeline format: remember that available formats include **Hours:minutes:Seconds:Frames** and **Absolute Frames**. Set up a windows screenset suitable for video editing, remembering, for example, that the video window is dockable, that media explorer is available to you for managing and accessing your source materials, and that track manager is available for managing your tracks.
4. Import your video files into your project. Video takes that run in parallel to each other (i.e. at the same time) should be placed on separate tracks. Items that are sequential may be placed on a single track.
5. Use markers and regions to help manage the media items in your project. Make such edits as you need to your video items.
6. If you need to replace the soundtrack of a video item with a separate audio item, display the video item's **Item Properties**, then click on the **Properties** button and enable the checkbox **Ignore audio**. The replacement audio item should be placed on a separate track.
7. Add transition effects and text titles.
8. Edit existing audio and/or add any new audio material that may be required.
9. When you are ready, [render your project to a single file](#).

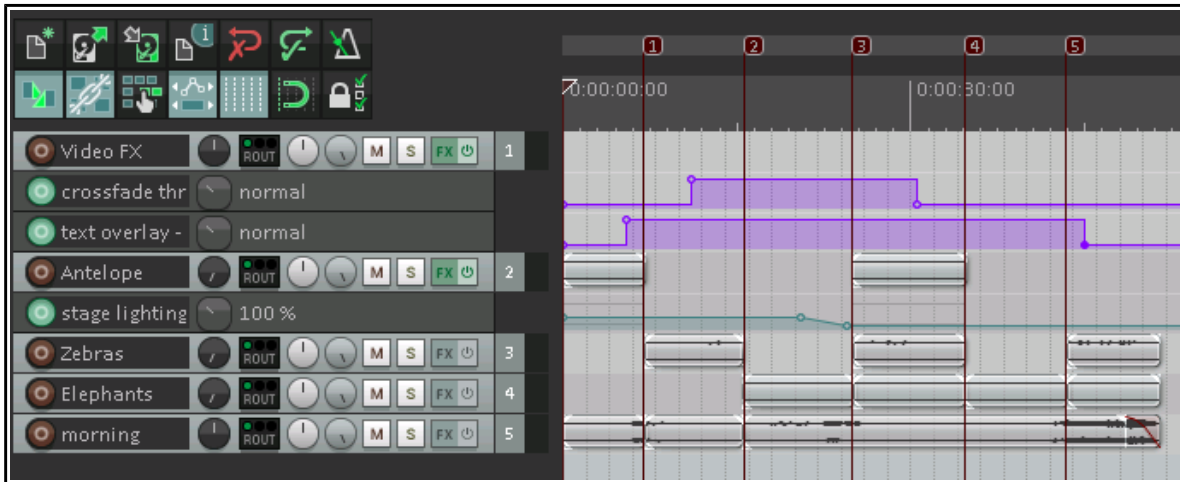

A simple example of such a project is shown above. This is included as **Wildlife2a** with your sample files.

20.10 Making a Home Music Video on a Budget

Here is an overview of one way that this process could be applied to making your own music video on a budget.

1. Work out your exact musical arrangement.
2. Video record the band playing the song to this arrangement. Make sure you include the sound in the recording. Using more than one camera will potentially make for a more interesting final product, because of the opportunities it offers to cut, crossfade, etc.
3. Create a new project file and import your video items, each to a separate track. Import also any additional video items (e.g. not of the band playing) that you wish to use. If you have more than one item, turn the volume on all but one track all the way down.
4. Using the video sound track as a guide track, overdub record every part (vocals and instruments) in the studio, as you would for a non-video project. Add any other audio material that you need.
5. Edit and mix the audio material in your usual way. Edit your video tracks as required. Save and render.

Exporting Files, Mixing Down and Rendering

21 Exporting Files, Mixing Down and Rendering

21.1 Introduction

There are three main tools available to you for taking your finished projects or tracks out of REAPER, for example for final distribution or for further processing elsewhere. These are:

- **Consolidate Tracks:** this outputs tracks pre-processing (ignoring for example track FX and panning). Use this, for example, if you are supplying files to be mixed/mastered by someone else.
- **Render to File:** this outputs your material post-processing (including for example all FX and panning). Use this to produce a final mix of your songs ready for distribution.
- **Batch File/Item Converter:** this takes a list of files at any stage in your project and converts them all to another format – e.g., to convert audio to MP3 for web distribution, or SFX for games to 22 kHz mono.

Both the Render to File and Batch Converter dialogs offer you the opportunity to make use of wildcards in your specifications and metadata in your output. The Consolidate Tracks dialog also allows the use of wildcards.

21.1.1 Wildcards

Wildcards allow information of specified types to be included in the metadata or rendered file name.

For example, including **\$project** in the filename will cause the project name to be included in the file name. Including a backslash (Windows) or slash (Mac) between wildcards causes a sub directory to be created. For example, naming your output files **\$project\strack** would cause a separate subdirectory to be created for the output of each rendered track.

\$author will include in the metadata any text saved in the [project settings](#) notes Author field.

Clicking the **Wildcards** button in the Consolidate Tracks, Render to Files or Batch File/Item Converter dialog causes a list of wildcards to be displayed. Many are self-explanatory (e.g. \$project will return the project name), but for explanations of those that are not obvious you can click on **Wildcard help ...** in the Wildcards sub-menu to open the window shown above.

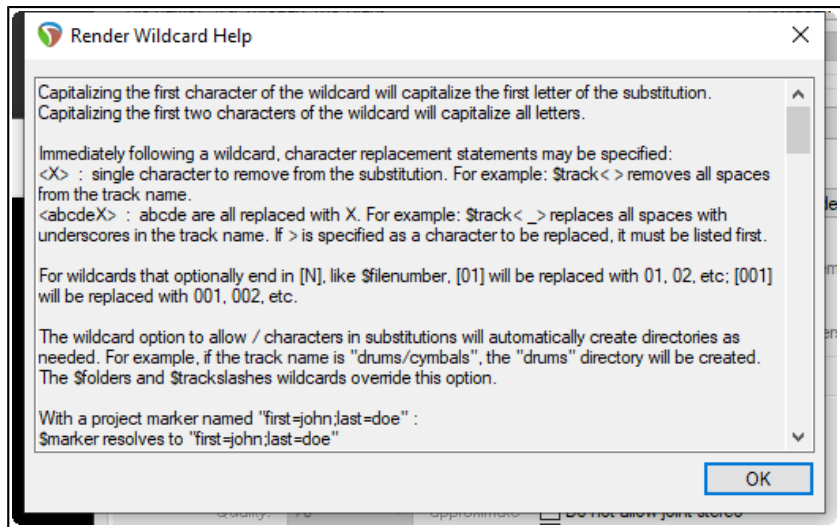

21.1.2 Metadata

Both the Batch File/Item Converter and Render to File dialogs allow you to include metadata in your output.

Metadata is information about a recording (e.g. song title, artist name, track number) that is stored in the file along with the recorded material itself. This information can then be read and used (and displayed) by other software and by electronic devices.

Different metadata schemes are used by different recording formats. ID3 is widely used (with MP3 files) but other schemes include BWF (WAV and FLAC), INFO (WAV), CART (WAV), CAFINFO (.CAF), VORBIS (FLAC, OGG, OPUS) and Sony ASWG metadata. To include metadata with your rendered files, first click on the Metadata button in the Render to File window to open and display the window shown above.

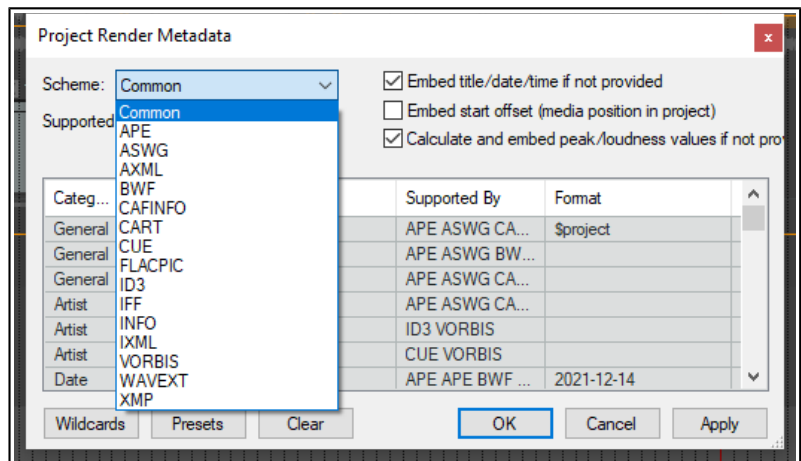

Up and Running: A REAPER User Guide v 7.31

Select your required scheme, then enter the information required in the appropriate fields. User defined fields can be included where the scheme supports it. The example shown here uses a combination of text fields and wildcards. Note also options to **Always embed title/date/time** and to **Calculate and embed peak/loudness values** into rendered file metadata.. When finished you click on **Apply** to save this information before clicking on **OK** to return to the Batch File Conversion dialog. Don't forget to enable **Embed metadata**. The **Presets** button can be used to save your current selection of settings as a preset which can be easily recalled and applied to other future rendering projects.

Note: The project render metadata window can also be opened from the main menu using the **File, Project render metadata** command.

21.2 Consolidating and Exporting

You might, for example, want to send your project to a friend to add vocal harmonies to your song. What if that friend lives a long way away and doesn't use REAPER? She might use a different DAW, or perhaps she will use a commercial studio. In any case, the project can be consolidated and exported.

In the example shown here, the Vox track is made up of three separate items. If we sent the six media files to someone else, it would be difficult to line the items up.

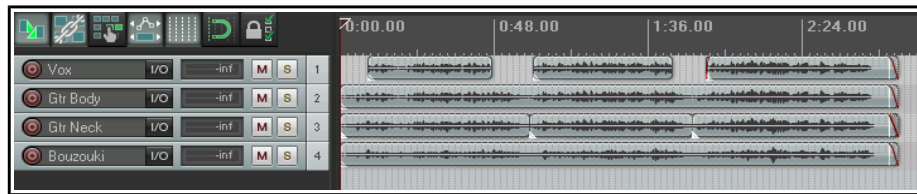

Consolidate and export creates a new set of audio files, one per track (minus FX, panning, etc.). When inserted in another DAW, each starting at zero time, one per track, then everything will be in the right place for further mixing.

1. Depending on what you wish to consolidate, if necessary make any time selection and/or track selection.
2. From the main menu, choose **File, Consolidate/Export Tracks**.
3. Choose **Entire project** or **Time selection** or **Custom** selection, then **All** or **Selected** tracks.
4. **Ignore silence** is a setting designed to prevent multiple files per track. In most cases you can leave this at its default value of 30 secs.
5. Decide if you want to have **sample rate** and **number of channels** automatically determined, or whether to specify these yourself.
6. Select a **Resample Mode**.
7. Specify **consolidation** format and **bit depth** – WAV, AIFF, DDP, FLAC, MP3, OGG Vorbis, OGG Opus, Video LCF or WavPack. In the example shown, WAV has been selected.
8. Select your required specifications for your chosen format. For example, for WAV files you need to select a bit depth and specify whether you want to use BWF data, include markers and regions, and how to deal with MIDI data. If in doubt, speak to the person to whom you will be sending the consolidated files.
9. Specify your **Output directory** (where the files will be written to).
10. Specify whether you wish to **update** your project with the newly consolidated files.
11. Specify a name for the new project file (or accept the default). Click on **Process**.

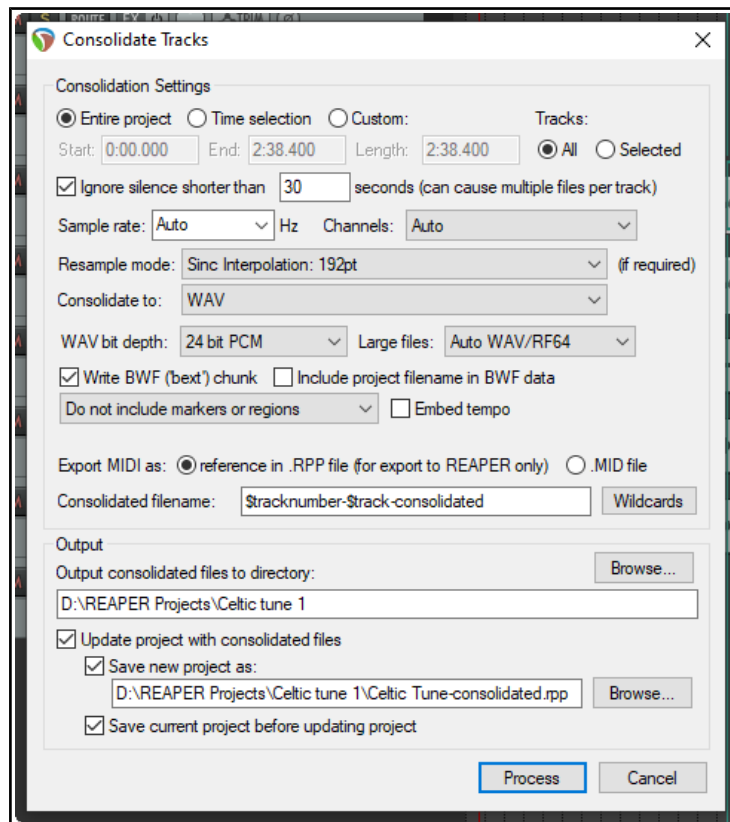

For a bound hard copy of the latest version of this User Guide (printed in B&W) go to LULU.com

Exporting Files, Mixing Down and Rendering

Note: Be careful how you use the option to **Embed tempo**. It adds an ACID tempo tag to the audio file(s). This may be interpreted by any tempo aware application so that the audio is stretched or processed when you do not wish this to happen. Only enable this option if you are certain you want the tempo embedded.

Shown here is an example of a project after consolidation, with one media item per track. These four items can be easily imported into any DAW program, with vocal harmonies then added.

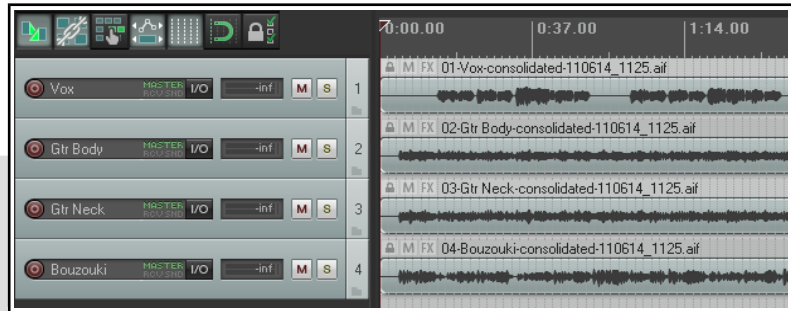

Note: To consolidate in MP3 format you need to have the correct free Lame encoder file for your platform and REAPER version. For example, for Windows 10/11 it will be either **libmp3lame.dll** or **lame_enc64.dll**.

This file is included with the REAPER download. Likewise, for output video rendering you will require an encoder such as **Ffmpeg.dll**, also included in the download.

When you consolidate media in this way your item settings and properties (e.g. take envelopes, take FX, item pitch adjustment) will be incorporated in the output files, but track based properties (e.g. track FX) will not be.

To apply your track FX chain, track envelopes, etc. to your output media, use the **Render to File** dialog, selecting **Stems (selected tracks)** from the Source drop down list.

21.3 Rendering A Project

As you'll find out before the end of this chapter, the **File, Render...** command has several uses. One is for rendering a complete project down to a single stereo file.

When you have finished your recording and edits, added FX and automation, arranged all your tracks now you want to produce an end product for distribution.

If you're aiming for an audio CD, you will need one 16-bit stereo wave file for each song on the CD.

If you're distributing thru the web, then probably you will need stereo MP3 files. Regardless of format, each project will ultimately need to be rendered down to one file.

Use the **File, Render** command (**Ctrl Alt R**). The dialog box (right) shows the various options. You must specify a directory and file name: if you wish, use the **Browse** button for either or both of these. Your other choices will depend on the ultimate destination of your material. A summary of **Render to File** dialog box options follows below.

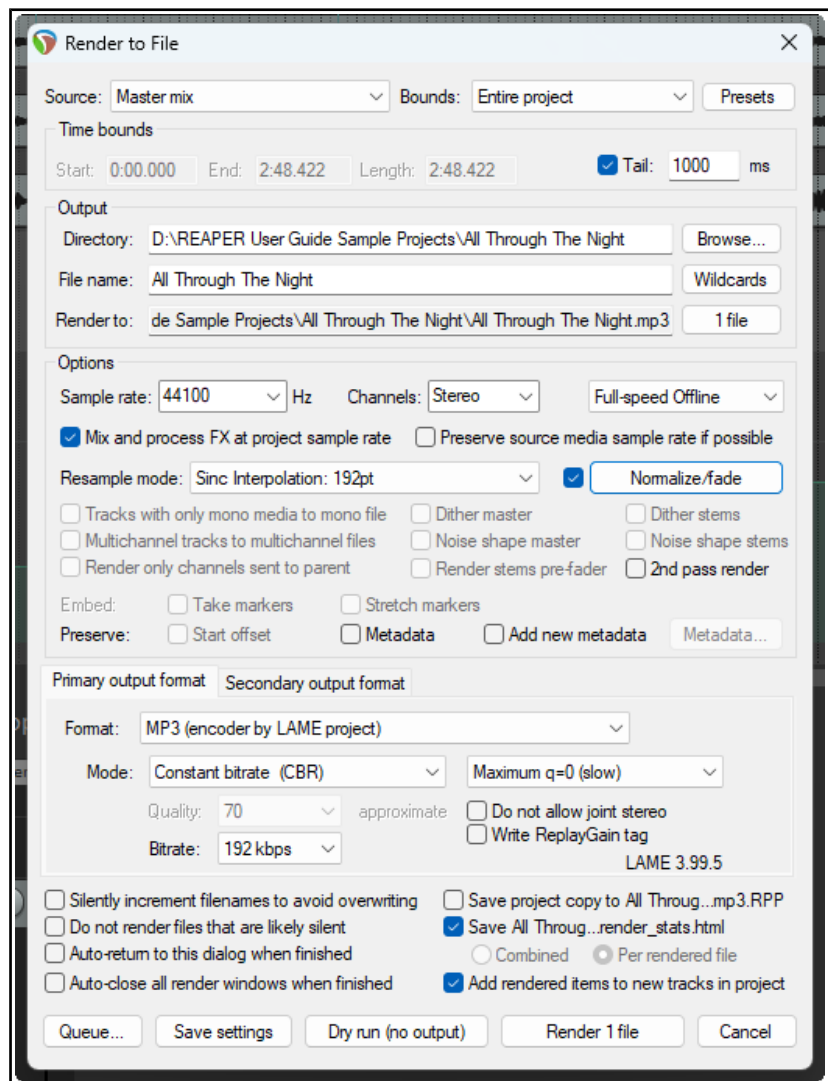

Up and Running: A REAPER User Guide v 7.31

Option	Explanation
Source	Master mix mixes to a single file, stems sends tracks to separate files, or both (more later in this chapter). Other options are region render matrix or selected tracks, media items or razor edit areas (optionally via master or as one file).
Bounds: options vary according to Source (e.g. bounds options for Master Mix bounds are shown here on right)	Select custom time range (use edit boxes), Entire project , Time selection (made in arrange view), Custom time range (enter start and end times in dialog) or Project regions (selected in Region/Marker Manager or Region Render Matrix). For Entire project , markers named =START and =END (if present) will be used to define start and end of project for rendering.
Bounds: project markers/selected markers	Choosing project markers causes a separate item to be rendered from each project marker to the next. Choosing selected markers causes a separate item to be rendered between each selected marker and the next marker.
Presets button	Displays a menu of options to saves settings as a preset, or load, rename or delete a previously saved preset. These can include Bounds and output settings only, Options and format settings only, or All settings .
Directory and File name	Any directory specified in Preferences will be used by default. Otherwise, type in a directory of your choosing or use the Browse button. Use Wildcards to include in the filename data such as track name or number, date/time stamps, etc. (Chapter 21.2.1). Wildcards help is available from the wildcards menu.
Sample Rate	Select a value in the range 8000 to 192000, depending on output format and other factors. Some examples follow in the table after this one.
Channels	Choose mono , stereo or select a number for multichannel output.
On or Off-Line Speed (see also note below table)	Full-speed (default) for fastest rendering. Others include 1 x offline, online (play mix while rendering), online (idle) and offline x 1 (idle). Idle assigns a lower system priority to the render thread, freeing PC resources for other tasks.
Preserve source media sample rate	Allows project sample rate to be used for mixing and FX/synth processing.
2nd pass render	Audio plays once before rendering, so that FX tails (e.g. reverb) are applied.
Normalize/Fade button (opens Postprocess Render dialog)	Normalize to RMS-I, LUFS-I, True Peak, Peak, LUFS-M max or LUFS-S max to a target level or Brickwall limit to Peak or True Peak . Optionally, only normalize files that are too loud. This can prevent clipping. Fades can be applied (in and/or out) of a length and shape that you specify. Options are enabled/disabled by the checkbox immediately left of this button.
Resample mode	Various options allow trade off between speed and quality. Default is 192.
Tracks with only mono media ...	Enabling this ensures that mono channel rendering will automatically be applied to tracks where all media items are mono or with a mono Item Setting.
Multichannel tracks...	These can be rendered to multichannel files. An example follows shortly.
Dither, Noise shaping (master mix and/or stems)	Not available with all output formats, commonly used when rendering 24 bit (or higher) audio material to 16-bit WAV format for audio CD. Creates a smoother transition to the lower sample rate in the rendering process.
Only sent to parent	If enabled, only channels sent to their parent will be rendered.
Render stems prefader	This option is available if the source option includes stems.
Preserve if possible	Options to preserve Start offset and/or metadata if possible. To Add new metadata click on the Metadata button. The wild cards button within the metadata window includes an option to display wild cards help.
Primary/Secondary output format	Select primary and optional secondary format for rendering, e.g. to render a file in WAV and another in MP3 format. Choose WAV, AIFF, CAF, Raw PCM data, Audio CD image (CUE/BIN), DDP, FLAC, MP3, OGG Vorbis, OGG Opus, video (Ffmpeg/libav encoder), video (GIF), or WavPack lossless compression.
Format specific options	Other options depend on the format, e.g., for WAV or AIFF files, bit depth, for FLAC encoding depth and data compression level, for MP3 mode and bitrate. WAV files allow embedded markers and/or regions as cues in the output file(s), and/or project tempo. The option Include project filename in BWF description is also available for WAV format: it associates rendered files with the source project .

Exporting Files, Mixing Down and Rendering

Option	Explanation
Embed tempo	This option is available for WAV and AIF files only. See section Embedding Transient Information when Rendering for detailed explanation.
Silently increment file names...	Prevents you from accidentally overwriting an existing file: an incremental number (001, 002, etc.) will be added if an existing file name is used.
Delay queued render to allow samples to load	Resolves problems that can be caused when samples (especially large samples) need to be loaded before rendering.
Save copy of project to outfile.xxx.RPP	Tells REAPER to make a time and date stamped copy of your project file, preserving all settings exactly as they are at the time of rendering.
Do not render ...	Optionally, do not render files that are likely to be silent.
Save all stats ...	Options to save stats for rendered file either combined or individually.
** Auto return ...	Automatically returns to this dialog box after rendering.
** Auto close all	Closes all render windows when finished.
Add rendered items to new tracks...	If enabled, causes your rendered file(s) to be added to the project as new tracks.
Queue	Add to or open render queue for rendering.
Save settings	Saves the render settings without rendering any files.
Render x files or Dry Run (no output)	Choose render to render one or more files, according to your options. Choose dry run to "test" render without actually rendering any files.

Unless those options marked ** above are enabled, when rendering is complete the rendering window will remain open. In addition to the features shown below, there will also be buttons to **Open folder** containing the rendered material, open the **Media Explorer**, **Launch file**, **Add file to project** and go **Back** to the Render to File dialog.

Note: Online vs Offline rendering: some plug-ins might perform and sound differently if rendered offline.

21.4 Dry Run Render Stats and Options

Whether you **render to a file** or choose the **dry run (no output)** option this window (right) will open while rendering and will stay open until you close it.

A dry run gives you an opportunity to identify and fix any potential issues such as clipping before finally rendering.

The display (right) includes the rendered waveform, markers and regions, statistics relating to loudness, and indications of any clipping. The example shown here reads **Clip 0**, indicating that there is no clipping.

Clicking anywhere on the waveform display in this window will reposition the cursor in the project itself.

Clicking and dragging along the waveform will mark a time selection in arrange view. There are many

further options available to you, including to calculate and show various statistics.

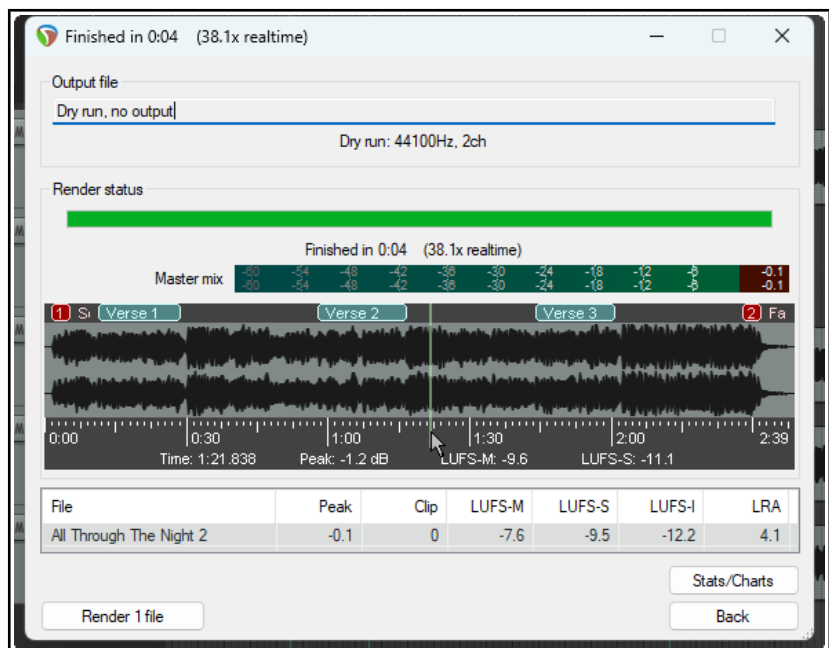

Up and Running: A REAPER User Guide v 7.31

The Waveform and its right-click context menu:

Click on the waveform to move the arrange view cursor to that position. Left click/drag to make a time selection in arrange view. Right click for a context menu:

Reopen window modelessly: Allows you to access the arrange view area to make any required changes without closing the Render to File window.

Insert project marker / Insert region: inserts marker at cursor position/creates region at time selection.

Clear time selection: removes current time selection.

Set project edit cursor to first clip position in project / Set project edit cursor to loudest sample position in project: moves the cursor position in the project to whichever of these is selected.

Display momentary loudness graph / Display short term loudness graph: superimposes whichever of these is selected over the waveform, as shown below.

Peaks display options:

Normal peaks, momentary loudness peaks, short term loudness peaks, momentary loudness graph, or short term loudness graph.

Mark overs in peaks display:

Marks the display with a vertical red line any points where 0.0 dB is exceeded.

Display peaks and loudness values in render peaks tooltips:

Causes peaks/loudness stats to be shown at position where mouse is hovered, as shown here (right).

The Stats/Charts button menu:

Open render statistic charts in web browser and Open render statistic charts in web browser (hide file paths): either of these two commands allow you to view statistical data even after the dry run/render window is closed. It can be printed or saved to a file.

Calculate stats when rendering:

From the **Calculate statistics when rendering** menu choose peak or true peak and the four RMS-M, RMS-S, RMS-I, RMS-RA or the four LUFS-M, LUFS-S, LUFS-I LRA. (These-terms are explained in the the [JS Analysis Loudness Meter](#) section in Chapter 6). There are also options to **Customize render statistics charts**, e.g. by displaying or hiding file paths, etc.

Dry Runs with Multiple Outputs

Some render master source options will produce more than one rendered file (e.g. selected tracks, region render matrix, selected media items, razor edit areas). In such cases REAPER performs a

separate dry render for each unit within the selection. Use the list of tracks/media items/regions/razor edit areas displayed below the graph to select which one to display and work on at any one time (as indicated above). In such cases, the resulting statistics can be sorted according to any column by clicking on its column header.

Tips

1. The **Render x file(s)** button: this will render to file without returning to the main Render to File window.
2. Running the action list action **Dry run render project using the most recent render settings** will perform a dry run render without the need to open the **File, Render** dialog.
3. Running the action **Calculate loudness of selected tracks via dry render** in arrange view will identify potential clipping etc. in individual tracks before rendering.

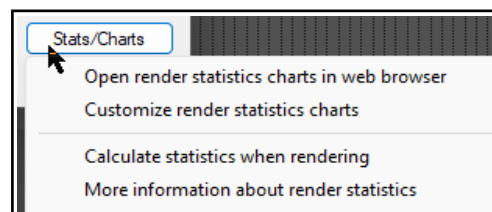
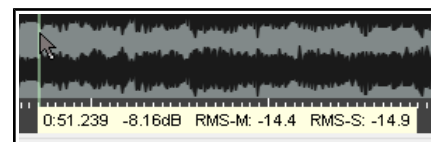
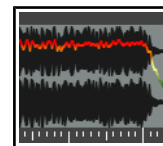
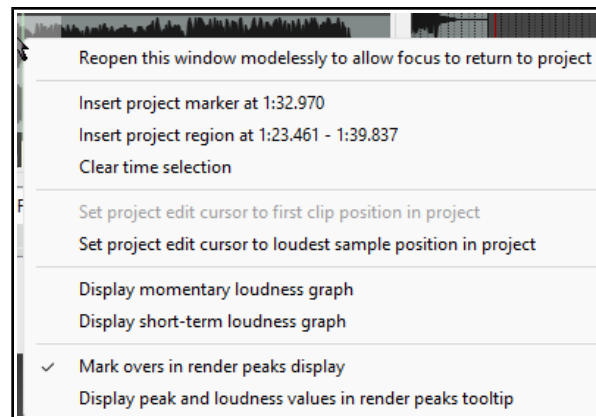

File	Peak	Clip	LUFS-M	LUFS-S	LUFS-I	LRA
Theres One Thing-001	-4.0	0	-19.8	-24.9	-27.9	6.2
Theres One Thing-002	-9.4	0	-19.6	-23.5	-27.6	8.3
Theres One Thing-003	-3.8	0	-12.4	-16.2	-20.6	7.5

Exporting Files, Mixing Down and Rendering

21.5 Render to File: Source Options

The table below summarizes the various rendering source options discussed in this chapter:

This option ...	Causes this to be rendered ...
Master mix	Sends the output of the master track to a single file: includes master track settings (volume, pan, mute, FX, sends. etc.) and automation.
Stems (selected tracks)	Outputs to a separate file for each track selected, post FX, post-fader and post-pan. Includes input from any tracks routed to that track (with faders/pans applied).
Master mix + stems	Outputs master to a single file, plus a separate file for each track selected: effectively selects both the options Master mix and Stems (selected tracks).
Selected tracks via master	Starts with same output as stems, but if in folder it passes thru folder (with folder FX but without its other media). Includes any sends to other tracks (with those tracks' FX but without their media) before passing to the master FX/fader.
Region render matrix	See dedicated section Rendering Regions .
Selected media items	Outputs one file for each media item selected. Includes track and item FX and faders but ignores sends from and receives to that track.
Selected media items via master	Outputs in a similar way to Selected tracks via master, but with one file per item selected instead of one file per track.
Razor edit areas	Outputs in a similar way to Selected media items (optionally via master) with one file per area selected.

Tip: to create a separate file for each track (or for selected tracks only) without FX, panning, faders etc. included, rather than using File, Render, consider using the [File, Consolidate/Export tracks...](#) command.

21.6 Project Rendering Examples

Example	Specification
DVD Audio	Sample at 48000 HZ, Channels: Stereo, Higher Quality. Output: WAV format, 24 bit
CD Audio	Sample at 44100 HZ, Channels: Stereo, Higher Quality. Output: WAV format, 16-bit
Apple Mac	AIFF Format. Preferred settings will vary with individual circumstances.
Web Site / Web Audio	Sample Rate 44100 HZ, Channels: Stereo, Higher Quality. Output format: MP3 Other options trade off files size and download time against audio quality, but a typical selection might be CBR (Constant Bit Rate) 96 or 128, Joint Stereo, Quality High
Audio CD Image (Cue/Bin) format	Specifications as for CD Audio. Burns output directly to CD, or creates image file to use with CD burning software. You can use markers or regions to define tracks, including using as track markers only markers whose name begins with "#". See section 21.9 .
Multichannel Tracks	We look at channel splitting and creating multichannel tracks in detail elsewhere in this User Guide, especially in Chapter 17 . Tracks can be exported in multichannel format. Select the tracks in the TCP, open the Render to file dialog box and include the options: Channels - Select the number of channels, e.g. 4, the select Render stems (selected tracks) to similarly named files . Select Render multichannel tracks to multichannel files . Optionally, Add items to new tracks in project when finished .

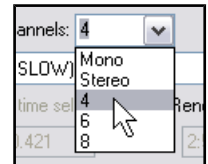

The [Action List](#) includes many actions relevant to file rendering, including:

- File: Render project using the most recent render settings** with the additional options to also **autoclose render dialog when finished** or **with a new target file**
- File: Add project to render queue using most recent render settings**
- File: Save project and render RPP-PROX**
- File: Show project render metadata window**

21.7 Rendering a Finished Song

When rendering a finished song some of your output format choices are likely to depend on your final destination is, e.g. for audio CD or the web. There are also considerations that are applicable in most cases Your recording might have a few seconds of silence before the song starts. If you do not wish to include this period of silence in your rendered material, follow these steps before rendering:

1. Position the play cursor at the point where you wish the rendering to commence. Press **Shift M** to create a marker at this point. Name this marker **Start**.
2. Position the play cursor at the point where you wish the rendering to stop. Press **Shift M** to create a marker at this point. Name this marker **End**.
3. With loop points linked to time selection, double click on the marker line (above the timeline) anywhere between the two markers. This selects the area between them.
4. From the REAPER menu, choose the **File, Render** command.
5. Select the required output format and other options as required, but be sure to include the option **Time selection** from the Render Bounds drop down list.. The settings shown at the start of section 21.4 would be suitable for producing a file in .WAV format for CD audio. .
6. Select other settings to suit, including whether you wish to embed [metadata](#) (see Chapter 21.2.2).
7. When you are ready, click the **Render 1 file ...** button in this dialog box to render your file.

21.8 Rendering a Group of Tracks to a Single Track

This example uses the [Render to File](#) dialog box: details and explanations of options and settings are explained earlier in this chapter.

You can apply stem rendering to a group of tracks in order to mix them down to a single audio file. To do this:

1. In Arrange View, put the required tracks into a track folder.
2. In the Track Control Panel, select the folder. No other track should be selected.
3. Choose the **File, Render...** command.
4. Selected options should include: **Selected tracks (stems)** and Channels **Stereo** or **Mono** (as you wish) and whether to **Render stems pre-fader**, as shown on the right. If you wish, also select the option to **Add rendered items to new tracks in project**.
5. Select your output format (e.g. WAV) and format (e.g. 16 bit).
6. Click on **Render 1 file...**

In the example here, the output of a folder is being rendered to a single stereo track. This will be added to the project.

When working with multichannel tracks you can also render your output in multichannel format. You will need to select the required number of channels from the Channels drop down list in the **Render to File** dialog box.

You'll learn more about file rendering, including multichannel rendering, in [Chapter 21](#).

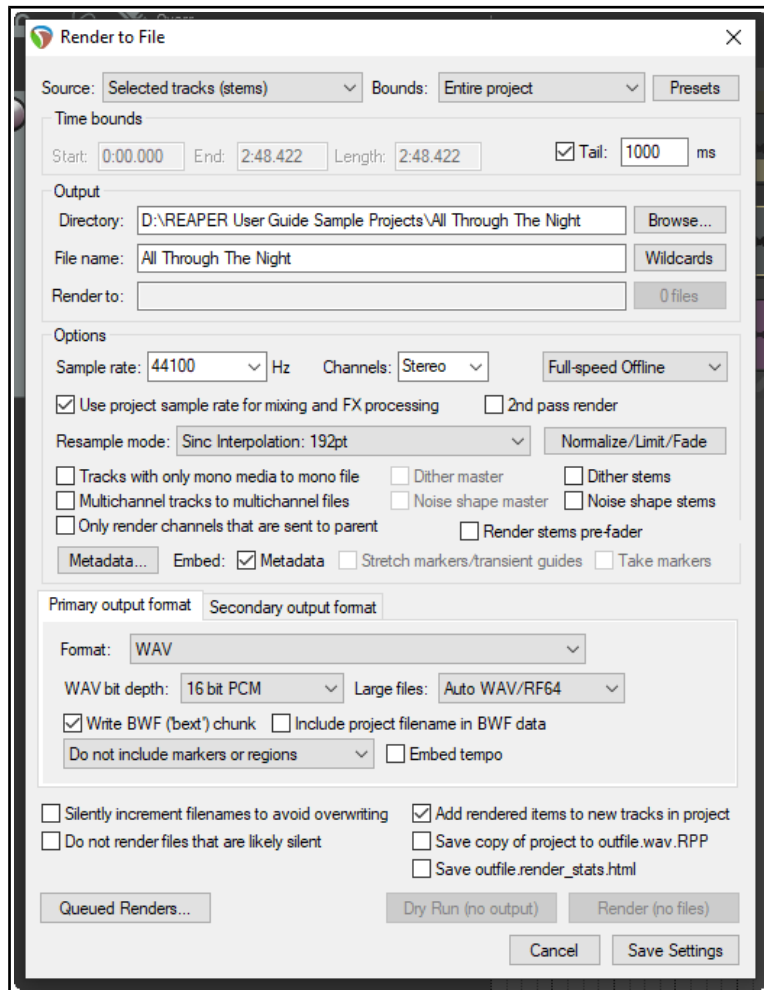

Exporting Files, Mixing Down and Rendering

21.9 Queued File Rendering

You might have a collection of songs that you wish to render together when the project is finished. That way, you can go away while REAPER renders the whole set, and then come back later. Follow this procedure:

For Each Project to be Rendered:

1. Open the project and choose the **File, Render** command.
2. Choose your various settings and options, as explained in the previous sections. You will probably want to select the same folder (directory) for all of the projects that will be included in the batch to be rendered.
3. Do *not* click the Render File button. Instead, click the **Add to Render Queue** button. When you add a file to this queue it is saved as it is at that point in time. If you make any later changes to the file that you wish to include, you should remove the file from the queue, then add it back again.
4. The dialog box will be closed, and nothing appears to happen. Save and close the file.

To Render the Queued Batch of Projects:

When you render the queue, each file will be rendered separately according to the settings and options that you made for each file individually when you set up the batch.

1. From the main REAPER menu, choose **File, Open Render Queue**.
2. This causes a dialog box (right) to be opened, listing queued files.
3. If you need to remove any item from the list, select it and click on **Remove Selected**.
4. *Either* use **Ctrl Click** to build up a subset of items to be rendered and click on **Render Selected** *or* simply click on **Render All** to render all items in the queue, each of course to a separate file. The **Rendering to File** box will be shown as each file is rendered and removed from the queue.
5. **Close** the Queued Renders dialog box when finished.

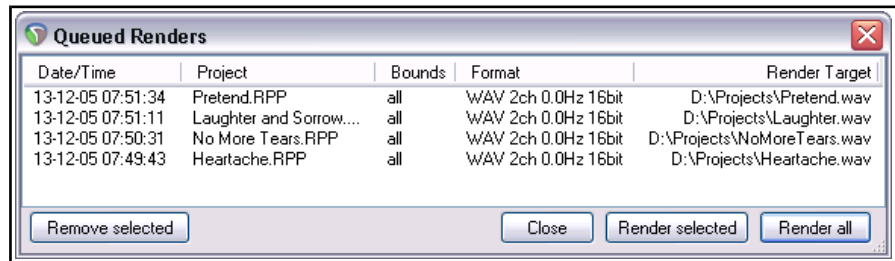

21.10 Rendering Regions

Defining your region rendering requirements can use a combination of three possible windows: **Render to File, Region/Marker Manager** and **Region Render Matrix**. For the most part you will not need to use all three together, but it will help you if you understand how these three windows can work together.

Of course, there are many reasons why you might wish to use and work with regions without rendering them as regions. However, there are other circumstances when you might wish to do this. After making your choices in the **Render Track List** column of the Region Render Matrix you could go to the **Render to File** dialog if you wish, selecting **Region render matrix** or **Region render matrix via master** as appropriate, with bounds set to **All project regions**.

However, there can be advantages in taking your **Render Track List** specifications (for example which regions to render and which tracks to include) into the **Region Render Matrix** where those choices will automatically be reflected, as is shown here.

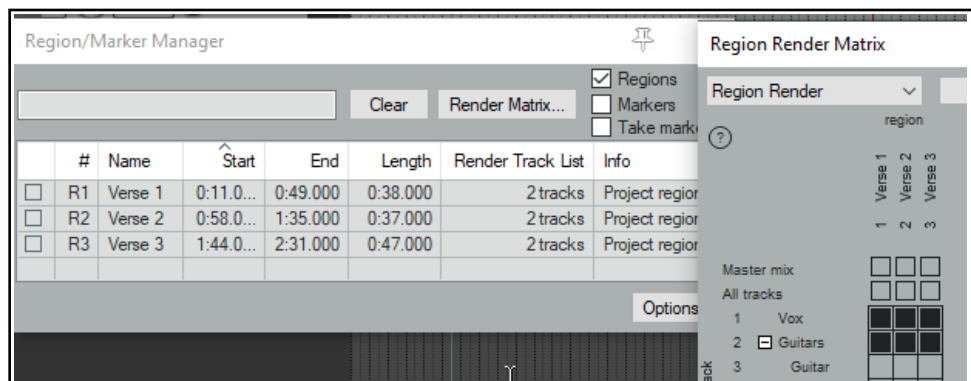

The **Region Render Matrix**, presents you with a further options as well as offering a direct route via a button to the **Render...** dialog. You can access this directly from arrange view, without needing first to visit the Region/Marker manager. Thus, it can be accessed in any of three ways:

Up and Running: A REAPER User Guide v 7.31

- From the main menu choose **File** then **Region Render Matrix**, or
- Click on the **Render Matrix...** button in the Region/Marker Manager window.
- In the **Render to File** dialog (**File, Render...**), select **Region render matrix** from the Render drop down list, then click on the **Region Matrix...** button (see below right).

To understand how this matrix works, look at the example below right. It uses a simple project of five tracks (including a folder). The song includes three regions – Verse 1, Verse 2 and Verse 3 .

In the first column (Verse 1), two guitar tracks (tracks 4 and 5) are checked. This would result in two files, one for each of these tracks, being rendered for Verse 1.

If we had checked All tracks, a separate file would have been rendered for each track, including the folder – five tracks in all.

In the second column (Verse 2) nothing is checked: this verse will therefore not be rendered.

In the third column, Master mix is checked, resulting in just one file being rendered for Verse 3 – a master mix of all tracks.

Within the Region Render Matrix, you can also click on the ? symbol (top left corner) to open a Help screen with more information.

Remember, selections can be made in either the Region Render Matrix or the Region/Marker Manager – the other one will be automatically updated, as shown here:

The Region Render Matrix right-click menu offers some useful shortcuts for selecting what is to be rendered and other options. This saves you having to keep clicking within the matrix to make your selections.

Render this track for this region simply does what it says.

Render this region will render all tracks in this region to a single file.

Render this track will render all regions for this track to a single file.

Render force mono/stereo/multichannel will render in the selected format (mono, stereo or multichannel) whichever choice you make from **This track for this region**, **This region**, or **This track**. For multichannel rendering you will need to specify the number of channels.

Select region simply selects the region.

You can choose to **Dock** or **Undock** the matrix window in the docker.

When you have made your choices, clicking the **Render...** button will open the **Render to File** dialog, then select **Region render matrix** and **All regions**.

Output format, etc. are specified in the usual way. Use a backslash in the file name to create subdirectories. For example, a file name **\$project\ \$region- \$track** will include project file name, region name and track name in the output files, with each region's files being allocated its own sub-directory. The file name **\$project\ \$track- \$region** would include project name, track name and region name, with this time a separate subdirectory for each track.

When ready, choose **Render xx files...** or **Queued Renders...** to proceed.

Tip: The action list includes an action **Region: Select/unselect all regions for rendering**.

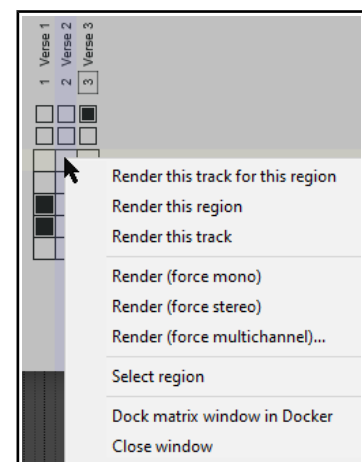
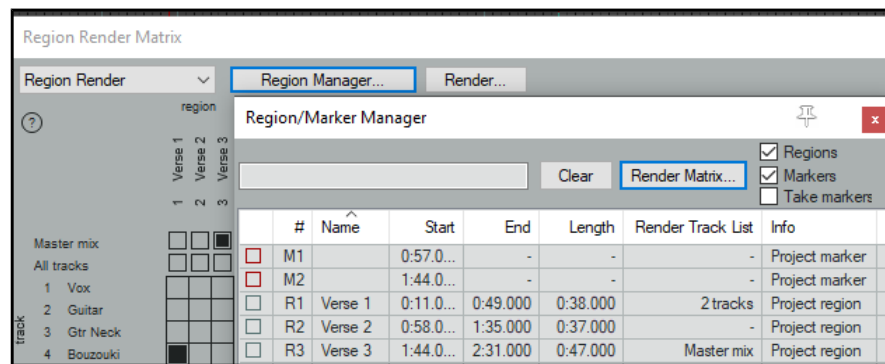
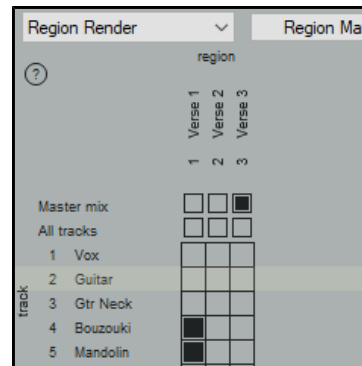
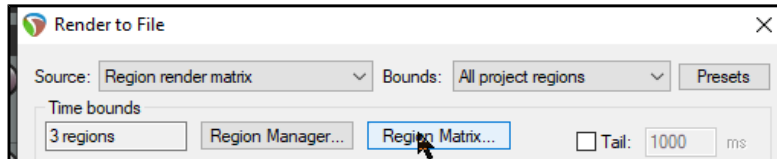

Exporting Files, Mixing Down and Rendering

21.11 Batch File/Item Converter

You might need to convert files or media items to a different format, for example from .WAV to .MP3, or to a different bit depth or sample rate. This can be done in one pass. REAPER's batch file converter (**File, Batch File/Item Converter**) can be used to do just this. Below is a summary of its options and parameters.

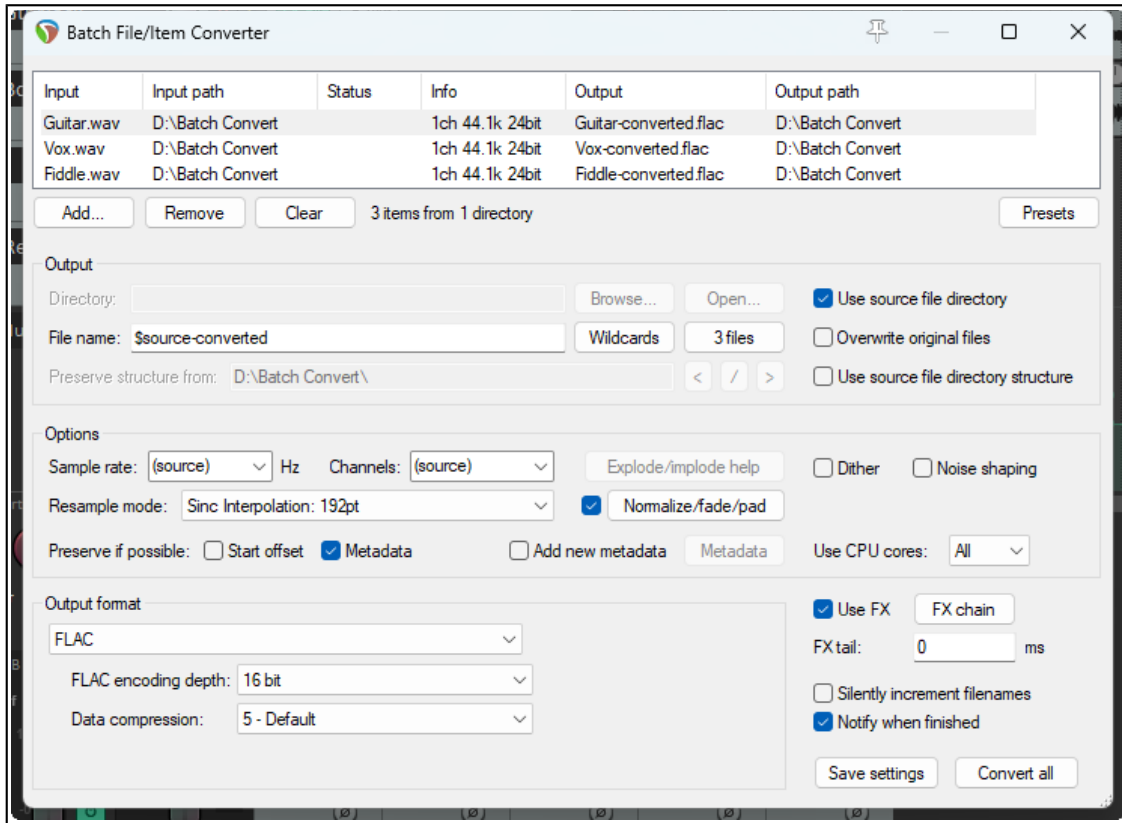

Media Selection

The **Add** button adds either **files** to be converted, or selected **media items** from the current project : information such as **channel count**, **sample rate** and **bit depth** will be shown. **Clear** and **Remove** are used to selectively remove files/media items from the list, or to clear the list altogether. Drag up/down to reorder files.

Presets can be a handy time saver. For example, you can save output settings as a preset.

Output Options

You can accept **Source Directory** to direct your output to the same directory as the input files, or **Browse/Open** explorer to select a different directory.

Alternatively, enabling the **Overwrite original files** option will cause your source files to be replaced in their current directory by the rendered file.

Input	Input path	Status	Info	Output
Guitar 1.wav	D:\REAPER Projects\ElizaStreet			OVERWRITE
Guitar 2.wav	D:\REAPER Projects\ElizaStreet			OVERWRITE

In addition, the right-click context menu includes options to **Add output files to current project** and/or **Replace input file with output file in current project** and/or **Open output file in Media Explorer**.

File Name

Wildcards can be used to define a naming strategy for your output files. Wildcards are explained more at the start of this chapter, but in brief ...

\$source-converted will cause the output file to retain its original name followed by the text string "converted". For example, **Vox 1.wav** could be rendered to **Vox 1-converted.flac**. Click the **Wildcards** button to select any that you wish, e.g. **\$project** for project name, or **\$length** for length.

Up and Running: A REAPER User Guide v 7.31

Options

Sample rate and number of Channels will by default be the same as the **source**, Thus, a 48 k mono item will be rendered to a 48 k mono item. **Sample rate** can be changed by making a selection from the drop-down – e.g. 44100, 96000, etc.

Channels options can be rather more complex. Selecting **source** will cause the rendered item to preserve the channel structure of the original – mono to mono, stereo to stereo, and so on. Beyond that, **Explode/implode help** is available: here are some examples:

A **mono** item rendered to **stereo** will produce a two channel stereo media item with the original material rendered identically to both channels.

A **stereo** item rendered to **mono** will produce a single mono media item.

A **stereo** item exploded will produce two separate mono files. A **six channel** surround sound item exploded will produce six individual mono files, one for each channel.

Resample mode.

Resampling can impact on your item's pitch, length or tempo and should only be attempted if you are confident about what you are doing. Should you need to apply it, you can make your selection from the dropdown.

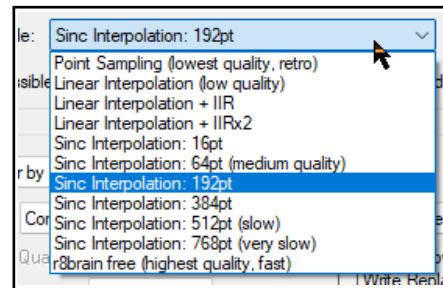

Post processing render

Professional audio engineers should note that the **Normalize/trim/fade** button opens a range of **Postprocess render** options. These are likely to be of limited interest to many casual home users, but in any event **Postprocessing help** is available. Options include:

Normalize peaks, using Peak levels or any of True peaks, LUFS-1, RFS-1, LUFS-MK max or LUFS-S max.

You can apply **Brickwall limiting**, with options to specify a dB level for peaks or true peaks.

Other options are to **Trim leading silence** and to **Trim trailing silence**. **Pad start with silence** and **Pad end with silence**, as well as to select which **Fade in/Fade out** curves are to be applied.

The adjacent checkbox in the batch file converter window toggles all postprocess render options on/off.

Metadata

Metadata is information relevant to the project that can be stored in the actual audio file itself. You can find a fuller explanation, with examples, at the beginning of this chapter. Here you have options to **Preserve existing meta data** (if possible) and to **Add new metadata**.

CPU Cores. If you know how many cores your CPU has you can specify how many of these want to allocate for your batch processing. The default setting is **All**. The more cores allocated, the quicker the processing.

Use FX: This option can be used to create an **FX chain** to be applied when processing.

Available **Output format** settings and options will depend on your chosen output format. Shown in the page above are the settings for FLAC.

21.12 Burning an Audio CD with REAPER

You might have a number of mastered projects to burn together to an audio CD. Another possibility is that you might have one long continuous live performance recording and wish to burn that to an audio cd with one track per song. In both cases the procedure is similar, with some slight differences in how you set the project up.

Preparing to burn a CD from several mixed files

1. Create a new project file. Open the **Media Explorer**, and navigate to display your rendered stereo wave files.
2. Double click in turn on each of the files to include in your CD. These are added to your project, lined up on separate tracks. Name each track with the song name.
3. Notice that each media item is inserted so as to begin immediately after the previous one, with no gap. It is not necessary to move any of these in order to create gaps on your CD. You will later be able to tell REAPER to do this automatically for you.

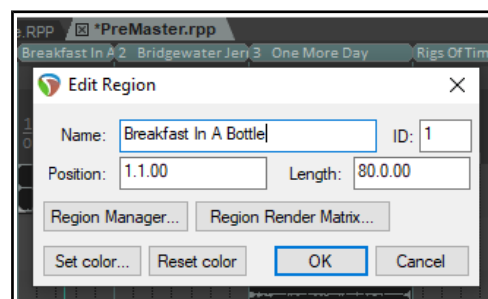

Exporting Files, Mixing Down and Rendering

- Turn snapping off and create a separate region for each track. To do this, in each case select the item, run the action **Time selection: Set time selection to item** then press **Shift R**. Name the region with the name of the song.

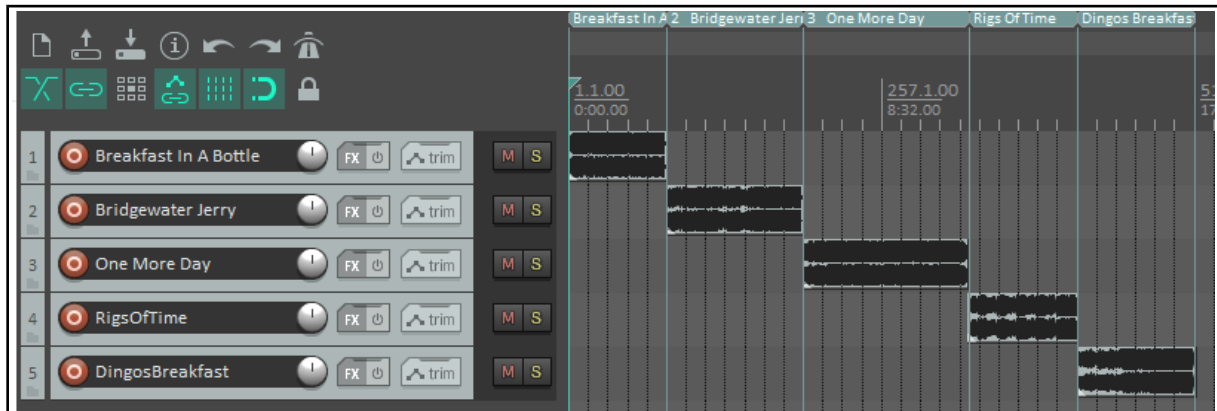

- Save the Project File. Now follow the instructions below for **Burning the CD**.

Preparing to burn a CD from one continuous recording

- If the recording was made in REAPER, open the project file. Otherwise, create a new project file and use Media Explorer to import the recording, using the method explained above.
- It is *not* necessary to split up the media item. REAPER will take care of this when it burns the CD. However, you will need to indicate where you want each track on the CD to start.
- Disable snapping. Place the cursor at the very beginning of your project. Press **Shift M** to create and edit a marker at this point. Name the marker name with a **#** followed by the song name..
- Now move the cursor to the start of the next song. Again add a marker, and again name the marker with a **#** and the song name.
- Repeat this to create a marker at the start of each song, as shown.
- Save the Project File.
- Now follow the instructions below for **Burning the CD**.

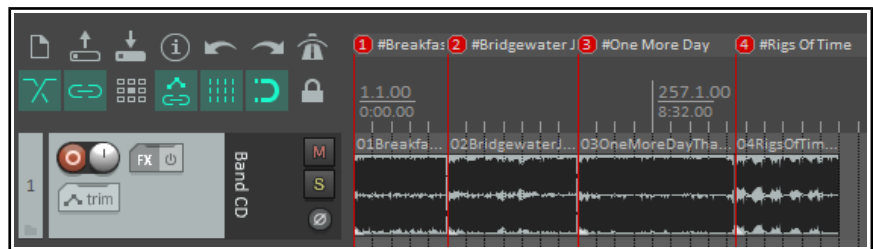

Burning the CD

- Choose the **File, Render** command. You should now select the necessary options and settings for burning your CD.
Format: Audio CD Image
Sample rate: 44100
Channels: Stereo
Render entire project
Render Master Mix
Output format: Audio CD Image (CUE/BIN Format)
Track mode *either* **Markers define new tracks** and **Only use markers starting with #.**
or **Regions define tracks**
Burn CD Image after render
If you are not using a dithering plug-in, consider also enabling **Dither** and/or **Noise Shape**.
- Optionally, you might wish to add **Metadata** (see note below).
- In the case of the first of our two examples (with separate media items lined up on different tracks) you might also want to specify a **Lead in silence for tracks** of 2000 ms.
- Click the **Render** button and wait for the output file to be rendered. This might take a few minutes.

- When rendering is completed, the **Burn Audio CD Image** screen will be displayed (see below).
- Your preferred **Method** will depend on factors such as your PC set up and operating system. If in doubt, accept the default that is offered. Click on **Burn CD**.
- Select **Eject CD when done**. Decide whether you wish to keep or delete the CD image files when done. It's probably worth keeping it, at least for now. If you have any problems with burning the CD itself here, you might well be able to use the image file with another CD burning program such as Nero or Toast.
- Insert a blank CD into your CD drive and wait for it to load, then click **Burn CD**.
- Wait while the **Burning in progress** message is displayed. Your CD will be burnt using the **Disk at Once** mode, and as such will be suitable for use by replicating or duplicating services.
- When finished, the CD will be ejected. Click on **Close** to close any messages still displayed.

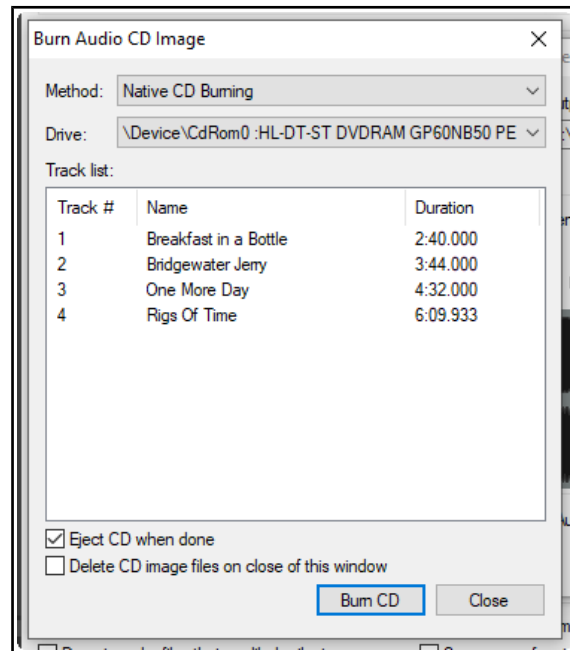

Instead of using markers to define the start of your tracks, you can if you wish create a separate **region** for each CD track and use the **Regions define tracks (other areas ignored)** option. Only that material which is included in your regions will be burnt to CD.

Tip: Before rendering direct to audio CD you should ensure that the media items that you are burning are in 16-bit 44100 Hz .WAV format.

This can be specified in **Project Settings** as your **Media format for apply FX, glue, open, copy, etc.** Within the project you can then glue any existing media item(s), while any media items you then import will be automatically converted to this format.

To add Audio CD image CUE format metadata:

After opening the **Metadata** window, select the scheme **CUE**. Options such as title and performer are available for the album as a whole and for individual tracks.

If you are using the Regions define tracks option, song titles will automatically be picked up from the region names. The window also shows additional options for automatically adding metadata from markers.

21.13 Saving Live Output to Disk

You can export live output to disk, using the **File, Save live output to disk (bounce)** command. This is similar to **File, Render**, except that export live to disk works in real time. You can make adjustments on the fly to your settings while your project is being mixed down.

Position the play cursor at the start of the section you wish to save (e.g. the beginning) and choose the **File, Save live output to disk** command. Specify output directory, file name, output format, etc. Options include:

Whether to include markers and/or regions, or

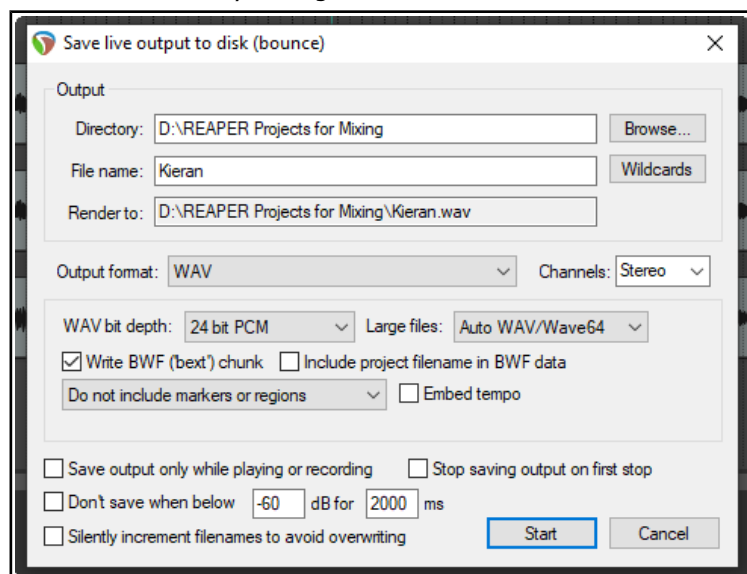

Exporting Files, Mixing Down and Rendering

markers/regions with #names in the rendered output.

Save output only when playing or recording: enables you to stop and start playback/recording whenever you wish, then later start again to resume bouncing to disk **/Stop saving output on first stop:** ensures that bouncing will finish when you stop playback or recording. It is unlikely that you would wish to enable both these options at the same time.

Other options include **Don't save** when volume drops below a specified level for a specified length of time, and **Silently increment file names to avoid overwriting.**

When you have made your settings, click on the **Start** button to begin bouncing. Choosing **Save live export to disk (bounce)** from the **File** menu will now cause the bounce to end.

This command has several uses, such as recording continuously a log of your sessions to a compact file format such as MP3, so that later you can hear everything that was said about each take even though the transport was stopped and nothing was being recorded on the tracks. One neat aspect of this is that you can use REAPER's media explorer window to locate and play back this file even while it is still being recorded.

If you do set this to run non-stop, however, remember to stop the recording when you no longer need it.

Tip: The actions list includes the action **Save live output to disk using most recent bounce settings.**

21.14 Surround Rendering

When rendering a project for surround format, most settings will be made as for any other project (such as a stereo mix). The one important difference is that you should be sure to select the correct number of channels.

For example, if the project is for 5.1 surround, 6 channels should be selected (as shown here).

REAPER will render this project into a single multichannel file.

You may later need to convert the interleaved multichannel file into multi-mono files of the type required by Dolby and DTS encoders.

REAPER itself does not do this easily, but there are a number of good tools available which will do this for you, such as **Wave Agent** - <https://www.sounddevices.com/product/wave-agent-software/>.

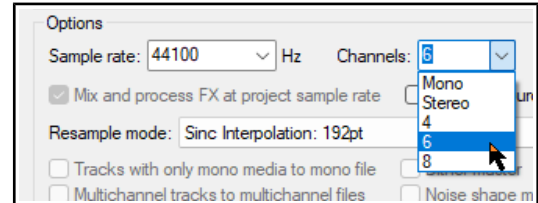

21.15 Rendering a Video Project

Rendering a video project is similar to rendering an audio project, but with a small number of options and settings that are specifically video oriented.

Most **File, Render...** dialog options serve the same purpose as for audio projects and do not need any further discussion here. These include render bounds, output files names and directory locations, sample rate, etc. The important differences can be found in the **Output format** section.

Output format: Video(GIF) is an option if your project contains no audio, but mostly you will want to select **Video(libav/FFmpeg encoder)**. You will then need to select a container **format:** options are AVI, QT/MOV/MP4, MKV or WEBM. Your choice of **video codec** and **audio codec** will depend on which container format you have chosen.

This will cause audio content to be rendered in your chosen format. You can select your preferred size and frame rate from the available list (see next page). Frames per second range from 24 to 60 and sizes range from 320 x 240 (QVGA) upwards. There are also options to **Keep source aspect ratio** and **Get width/height/framerate from current video item.** Note that the **Get width/height/framerate from project** option can only be applied if these values have been set in your project settings.

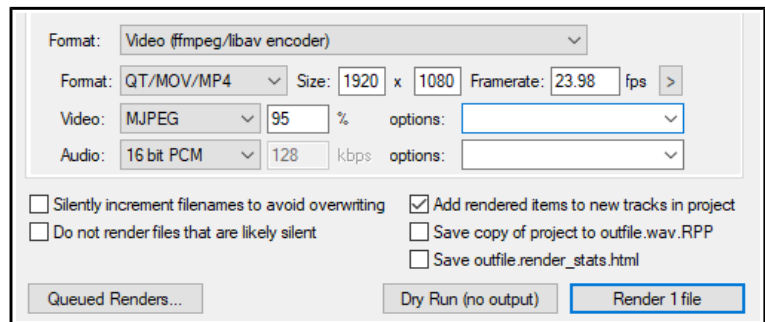

Up and Running: A REAPER User Guide v 7.31

If using the **Video (ffmpeg/libav encoder)** you will need the **Video codec** VP8 and **Audio codec** VORBIS. Note that you do also have the option to render in audio only, or video only: in this case, select **None** as the codec for whichever one you do not want. This applies to AVI, MP4 and WEBM formats.

The remaining options have already been explained. These include the options to **Add to render queue** for processing later or **Render file** in real time now.

Note: REAPER supports rendering to common video formats on macOS "out of the box" by using AVFoundation. Note that the AVfoundation encoder allows encoding of video only in .m4v or .mov formats.

For Windows, REAPER includes a limited version of FFMPEG. If you want or need more video rendering formats you will need to install the full FFMPEG libraries. These are available for download from <https://ffmpeg.org/download.html>

The downloaded and unzipped .DLL files will need to be placed in Reaper's User Pllug-ins folder. This can be accessed via REAPER's **Options, Show REAPER resource path in Explorer** command.

Video preferences (**Options, Preferences, Media, Video**) include the field **Video decoder priority**. At or near the start of the list you should see *ffmpeg* (and possibly also *vlc*). The order of these two decoders will determine which is chosen first for playing video in REAPER (but not for encoding a video). You can edit this order. Sometimes FFMPEG will work better than VLC; you may want to change the order of the video decoders if you are having problems seeing video in REAPER.

21.16 Stem Rendering Media Items

Stem Rendering can be applied to ease your CPU load. The item(s) is/are rendered to a new track, whilst the original track remains but is automatically muted and its FX are bypassed. If you later wish to change the FX in a stem rendered track, you can delete it, unmute the original, and make your changes. To make a stem track:

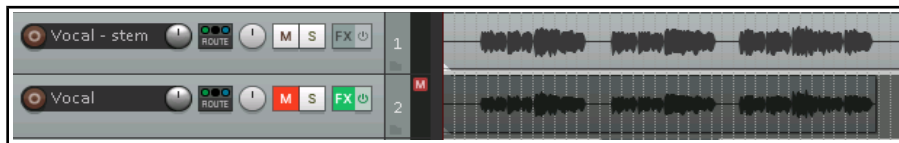

1. In the **Track Control Panel** area, right-click over the track number.
2. From the menu, choose **Render/freeze tracks**, then one of the **Render tracks to ... stem tracks (and mute originals)** commands. Your choices are **mono**, **stereo** or **multichannel**.

The first of these will render to a mono item (as shown here). The second will always produce a stereo item. The number of channels produced when multichannel is selected will be determined by the number of channels that you have defined for the track. By default, REAPER tracks comprise just 2 channels. As well as track FX, any audio or MIDI received from sends from other tracks is included in the rendered material.

Stem rendering is similar effect to [freezing tracks](#). One difference is that stem rendering leaves both the rendered and the unrendered tracks in the project. If you do not wish to keep both tracks, consider using one of the **Render/freeze** freeze actions instead.

Stem rendering is also available with an extensive range of options (such as output format and quality) using the **File, Render...** command. This opens the [Render to File](#) dialog box.

Stem Render Actions

REAPER's [Actions List](#) includes several actions that can be used to accommodate particular requirements when stem rendering. To browse all these actions, search the Actions List for the text string *stem render*.

For example there are actions for:

- 2nd pass rendering: these ensure that REAPER will play the render area through a second time before rendering: this ensures that effects such as reverb tails are included in the rendered item.
- Rendering selected area of tracks to mono, stereo or multichannel, including other options, such as to mono, stereo or multichannel.
- Rendering selected area of tracks to multichannel (parent send only) stem tracks.

REAPER's Preferences and Other Settings

22 REAPER's Preferences and Other Settings

22.1 Introduction

At several places in this User Guide we have encountered the use of preferences and settings. In this chapter, you will learn other ways in which you can use REAPER's preferences and other settings to tailor the program more closely to your particular requirements. Many options can often best be left at their default value.

REAPER's preferences window is opened vis the **Options, Preferences** command, or by pressing **Ctrl P**.

Resizing the Preferences Window

Like many other windows, the Preferences window can be resized to suit if you wish. Hover the mouse over any edge or corner (example shown here), then drag outwards as required.

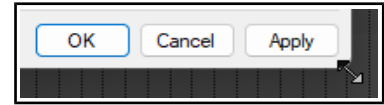

22.2 General Preferences

REAPER's General Preferences page is explained in Chapter 2. You can refer back to that chapter to refresh your understanding of these.

In addition, this page includes a link to **Advanced UI/system tweaks**. These are discussed [towards the end of this chapter](#).

22.2.1 General, Undo Preferences

REAPER's Undo settings determine not only how undo (Ctrl Z) will behave in real time but also what events will be stored in (and can be recalled from) the **Undo History** window.

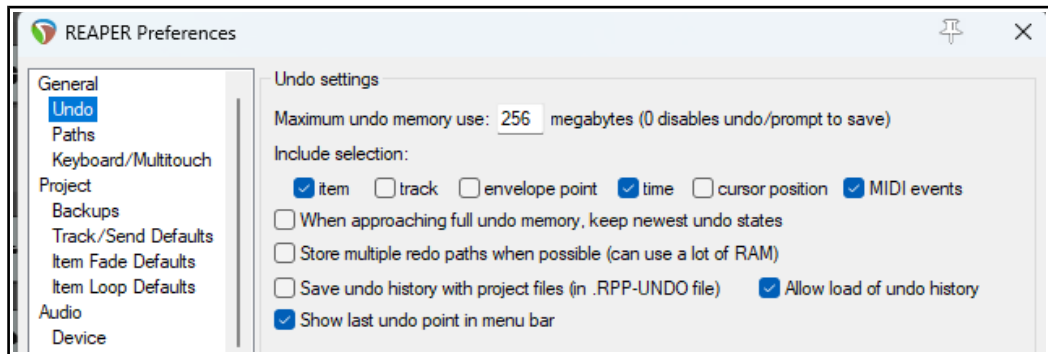

the **Undo History** window.

- ◆ **Maximum undo memory:** determines how much memory is available for the undo history.
- ◆ **Include selection:** which action categories to respond to undo – e.g. actions pertaining to items. Tracks, time, cursor position and/or MIDI events.
- ◆ Whether to keep **newest undo states** when memory allocation approaches full.
- ◆ Whether to store **multiple redo paths** where possible (see also [section 22.13](#)).
- ◆ Whether to **save the undo history with project files**.
- ◆ Whether to **allow the load of undo history**.
- ◆ Whether to **show the last undo point in the menu bar**.

22.2.2 The Find Box

The **Find** box (bottom left of window) can be your best friend in searching for what you want.

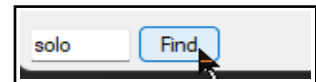

For example, type **solo** to find only those preference options pertaining to solo.

Type **solo OR mute** to find both solo and mute preferences. Every time you then click the Find button, the next relevant preference will be highlighted. For more details and tips, see the section [Using Search Filters](#).

The find mechanism will also search the help text as well as the actual item. For example, a search for **beat** would also find many preferences referencing measure or tempo where **beat** is referenced in the help text.

22.2.3 Tooltips and Help Messages

Hovering your mouse over any preference option will cause a relevant help message to be displayed at the foot of the preferences window, next to the Find button.

22.2.4 Import and Export Configuration

Export configuration can be used to export to a .ReaperConfig.Zip file any permutation of your settings.

Import configuration can be used to import a previously saved settings file back into REAPER. This can also be done by dragging and dropping a .ReaperConfig.zip file from Explorer or Finder into REAPER's arrange window. You will be prompted to confirm that you really want to do this.

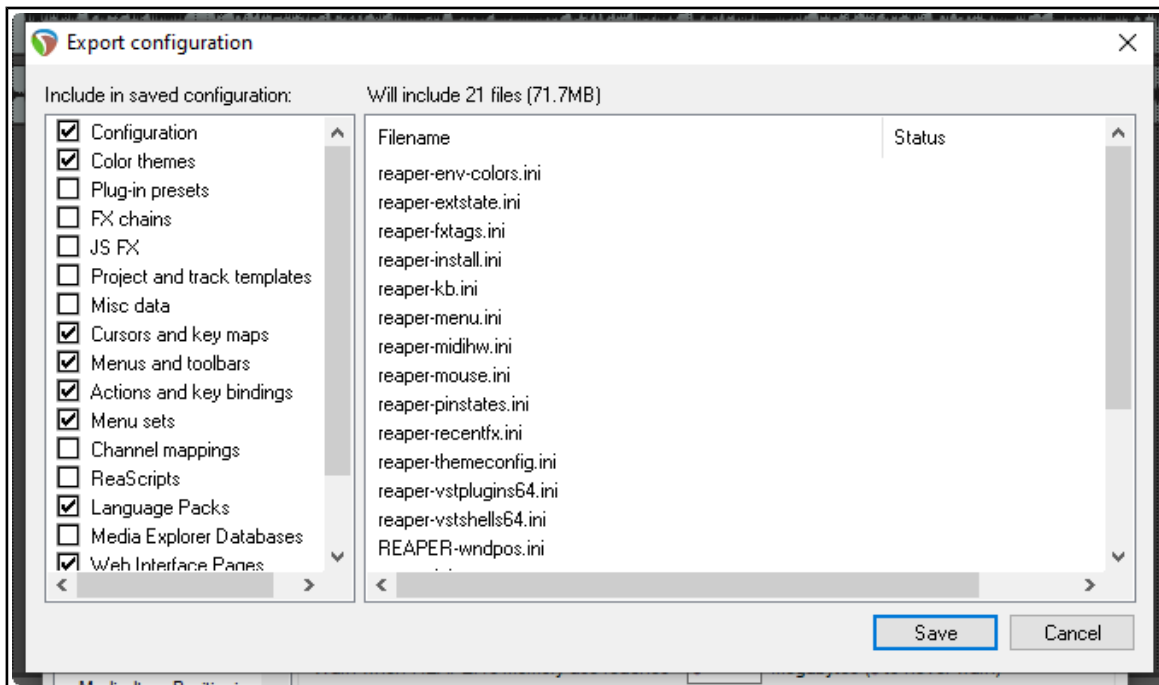

Any permutation of the following elements can be selected for inclusion in a ReaperConfig.zip file:

Configuration	Miscellaneous data	ReaScripts
Color themes	Cursors and key maps	Language Packs
Plug-in presets	Menus and toolbars	Media Explorer Databases
FX Chains	Actions and key bindings	Web Interface Pages
JS FX	Menu sets	Automation Items
Project and track templates	Channel mappings	MIDI Note/CC Names

In the first column, tick the categories to be included. The second column will then show you which files have been selected from the currently selected category for inclusion in your ReaperConfig.zip file. After making all your selections in the first column, use the **Save** button to create the file.

Import and export configuration exists side by side with the individual import/export options that are available within many of REAPER's different elements. For example, to export only your actions and key bindings you would be most likely to use the **Import/export...** button within the Actions window.

If, on the other hand, you wish to export your actions and key bindings along with various other settings, such as perhaps menu sets, FX chains and ReaScripts (perhaps to be imported into REAPER on another computer), then you would be more likely to use the screen shown above.

Tip: It can be a good idea to create a .ReaperConfig.zip file that includes **all** the above elements and keep a copy as a backup on a CD, external hard drive or flash drive (or all three!) in case of system failure.

REAPER's Preferences and Other Settings

22.2.5 Paths

You can set (separately) default paths for REAPER to use when **saving** new projects, **rendering**, **recording**, and/or for storage of **waveform peaks**. The last of these will only be applied if under Preferences, Media the option to **Store all peak caches in alternate path** is enabled. If no render path is specified, the project directory will be used.

You can set a relative path for rendering. For example, if you specify an existing directory C:\Reaper Mixes as your default render path, then this will be used as a default relative path when you open the **File, Render** dialog box. If you accept this default when rendering, a sub-directory of that name will be created in the project directory. For example, if you have a project called *Hello* stored in a folder C:\REAPER Projects\Hello, then your rendered file(s) for that project will be placed in a directory C:\REAPER Projects\Hello\Mixes.

Alternatively, if you specify (for example) C:\Reaper Mixes as the default render path, then by default, C:\Mixes will be used as the absolute output directory for rendered files, regardless of where the project is located.

22.2.6 Keyboards/Multitouch

This page consists of two main sections – **Keyboard** and **Multitouch**.

The **keyboard** section includes the following:

Commit changes to some edit fields after 1 second of typing. Enabled, this allows, for example, a play rate to be typed in to the relevant Transport Bar field without your needing to press **Enter**.

Use alternate keyboard section when recording. You must enable this if you wish to use your Main (Alt recording) keyboard shortcuts when recording.

Prevent ALT key from focussing main menu.

Enabling this will stop the main menu getting focus when the Alt key is pressed.

Allow space key to be used for navigation in various windows.

When space key is pressed in plug-in text fields, send to main window.

Clicking on either of the two links will open the action list editor (**Assign keyboard shortcuts**) or your web browser with a list of keyboard shortcuts (**View keyboard shortcuts as**).

The other section allows you to customize the behavior of a **Multitouch** trackpad or similar device. Refer to the Preferences, General, Keyboard window and your device's documentation for a list of options.

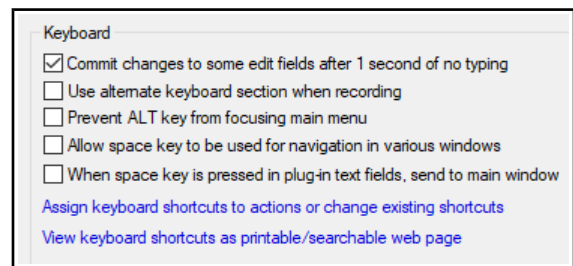

22.3 Main Project Preferences

REAPER's main **Project** settings include:

- Option to specify a **default .RPP** file to use as a **template** for new projects.
- Whether to prompt you to save whenever a new project is created. .
- Whether to **open** and display the **project properties window** when a new project is created - for example, if to set a project time signature or timebase different from your default.
- Whether to look for project media in a project directory before looking in otherwise default paths.
- Whether to warning you if attempting to load a project that cannot be found.
- Whether to show the file load status and REAPER's splash screen when a project is loading.
- Whether to save project file references with **relative pathnames**. This can be useful, for example, if a project is likely to be moved from one disk to another.
- Options to specify a default wildcard pattern in file name when using File, Save as... command.
- Option to open Project Settings.

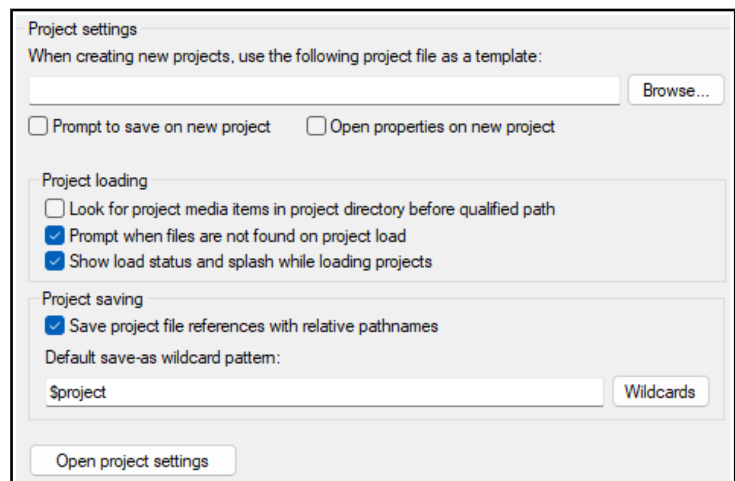

22.3.1 Project Backups

Make yourself familiar with the various backup options described here.

Good management of backup procedures can achieve the twin objectives of keeping secure copies of your projects and media files without overloading your disk(s) with unnecessary file clutter.

By default, when you first install REAPER these options are all set to off.

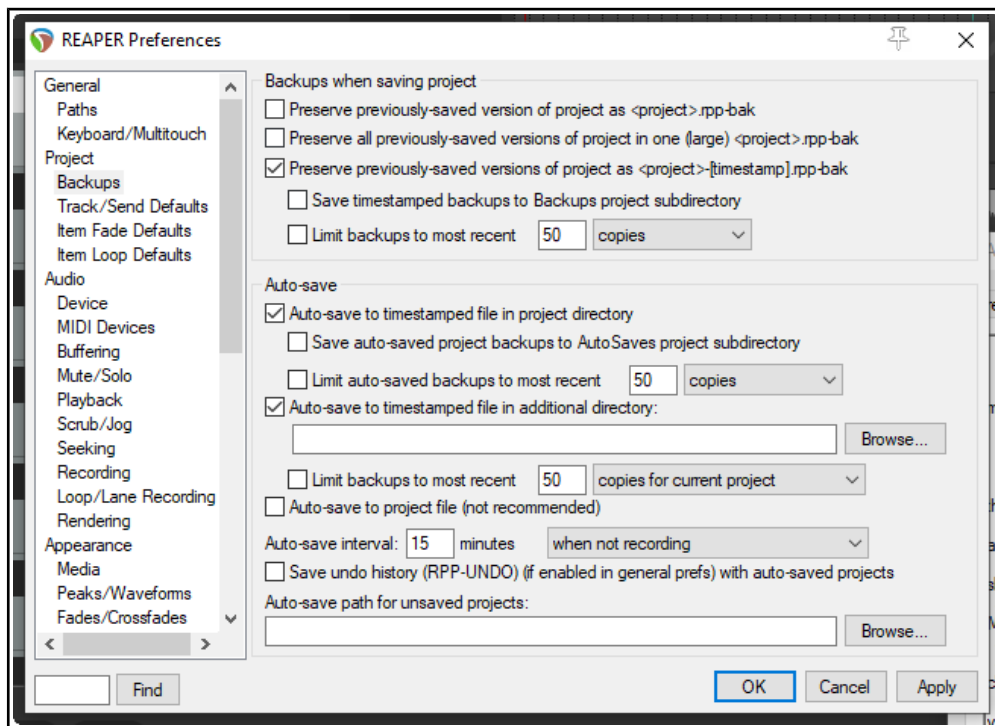

Backup options are:

- ◆ **Backups when saving project.**
 - ◆ **Preserve previous saved version as rpp-bak file, or**
 - ◆ **Preserve all previously saved versions of project in one large rpp-bak file, or**
 - ◆ **Preserve previously saved versions of project as timestamped rpp-bak file, or**
 - ◆ **None of these.**
- ◆ **Save timestamped backups to Backups project subdirectory.** Helps to keep backup files organised and accessible.
- ◆ **Limit [number of] backups to most recent *n* copies or unique days.** Sets a limit to prevent obsolete or redundant backups creating too much file clutter on your disk(s).

Auto-save options are:

- ◆ **Auto-save to timestamped file in project directory.**
 - ◆ **Save auto-saved project backups to Auto-Saves project subdirectory.**
 - ◆ **Limit auto-saved backups to most recent *nn* copies or unique days.**
- ◆ **Specify directory for auto-saves to timestamped file.**
 - ◆ **Limit backups to most recent *nn* copies for current project, or unique days for current project, or copies for all projects, or unique days for all projects.**

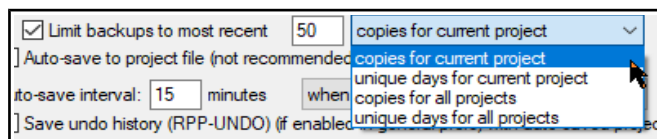

- ◆ **Auto-save to project file.**
- ◆ **Set auto save interval to *nn* minutes when not recording, or when stopped, or any time.**
- ◆ **Save undo history (RPP-UNDO) (if enabled in General Prefs) with auto-saved projects.**
- ◆ **Specify auto-save path for unsaved projects.**

REAPER's Preferences and Other Settings

22.3.2 Project, Track/Send Defaults

There are two groups of default settings here – one each for **Tracks** and **Sends**.

- **Track volume fader default gain:** sets the initial volume fader level for new tracks. Default is 0.0 dB.
- **Default visible envelopes:** allows you to specify any track parameter envelopes (e.g. Volume, Pan) that you would like automatically displayed for new tracks.
- **Default envelope point shape:** sets the shape for new envelopes (e.g. Linear).
- **Default automation mode:** sets automation mode (e.g. Trim/Read) for new tracks.
- **Default track height in new projects:** choose from small, medium and large.
- **Show in mixer:** whether or not new tracks by default are shown in Mixer.
- **Main (parent) send:** whether send to Master (top level tracks) or parent folder (child tracks) is by default enabled for new tracks.
- **Free item positioning:** whether FIPM is by default enabled for new tracks.
- Whether by default to set new tracks as **Fixed item lanes**.
- Various default options for **fixed lane defaults**, including **Small** or **Big lanes**, whether to **Show/play only one lane**, **Hide lane buttons**, for **Media items in higher numbered lanes to mask playback of lower numbered lanes**, to **Allow editing source media while comping**. By default REAPER will **Create comp areas for new recordings while comping** and **Automatically delete empty lanes at bottom of track**.
- **Record-arm:** whether new tracks are automatically armed for recording.
- **Record config:** click to set default recording settings for new tracks (see right): e.g. whether monitoring is on, whether to record audio input or MIDI, default input source.
- Whether **scaling** for **volume envelopes** should default to amplitude or fader.
- **Track meter display options** for new tracks– multichannel, stereo, RMS, LUFS, etc. There is an option to show gain reduction for those plug-ins that support it.
- **Sends/Track Hardware Outputs Send default gain:** default volume fader level for new track sends.
- **Hardware output default gain:** default volume fader level for new hardware sends.
- **Sends/hardware output default mode:** set default to Post fader/Post pan, Pre-fader/Post FX or Pre-fader/Pre-FX.
- **Sends ... by default:** whether sends by default include audio or MIDI or both.

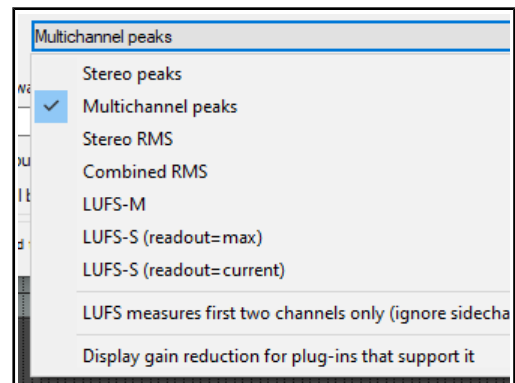
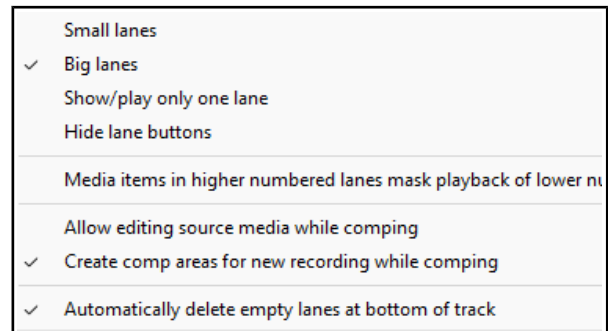
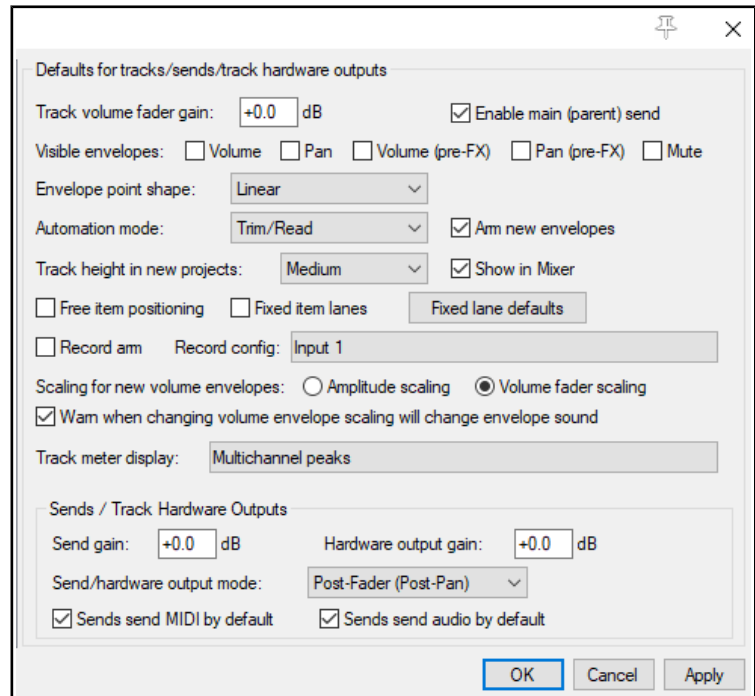

22.3.3 Project, Item Fade Defaults

Options include whether to:

- Specify default fade lengths.
- Use auto fade-ins/fade-outs on new items, and how long they should be.
- Disable fades for imported items.
- Whether to apply fades to imported items and/or fixed lane comp areas.
- Whether to overlap and crossfade recorded media items and/or split media items, or whether to respect the toolbar crossfade settings.
- When crossfading, whether to crossfade to the left or right, or center.
- Whether to enable trim content behind media edits and/or razor edits.
- Specify max limit (default 50 pixels) for fades/crossfades when splitting.
- Whether to ensure right-clicking on one side of crossfade set changes only that side (use **Shift** to toggle).
- Whether to apply crossfade settings and project auto-crossfade setting to MIDI items. Fades on MIDI items affect note velocity, not volume.
- Specify a stretch marker fade size for new items.

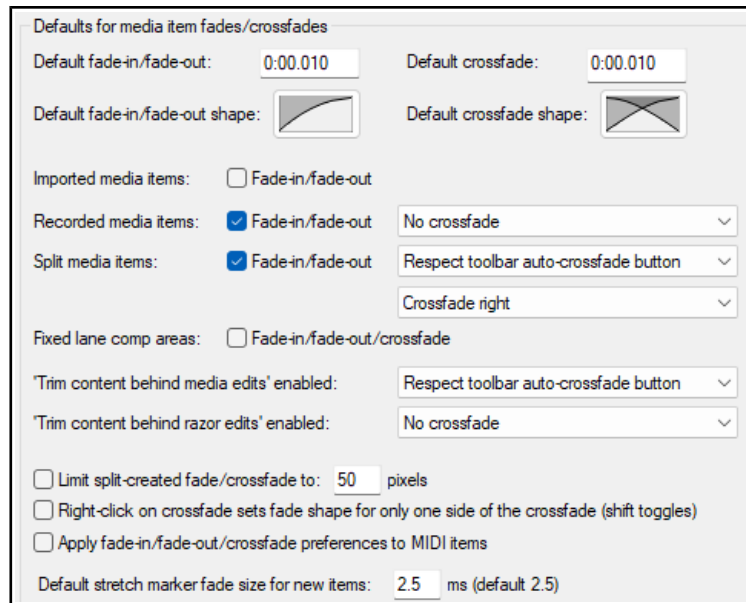

22.3.4 Item Loop Defaults

- Loop source any/all of imported items, MIDI items, recorded items, glued items.
- Ensure time selection auto-punch audio recording should create a loopable section.

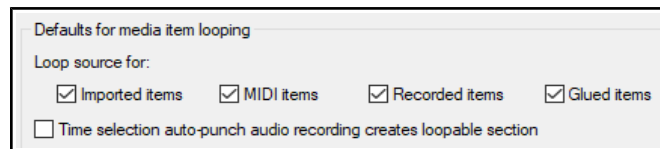

22.4 Audio Configuration and Settings

Let's look again at the **Audio Device** preferences screen. Two important issues here concern **buffers** and **latency**. Understanding what these terms mean will help you in obtaining the optimum settings for your system. Getting buffer size right is essential if you are to get the best performance from your audio interface. Make them too small and you'll get audio clicks and pops; make them too large you'll notice delays in your headphones when you're input monitoring, especially with software synthesizers.

The goal is to achieve the lowest possible latency without experiencing dropouts. The optimum setting depends largely on your audio interface (PCI sound card, firewire or USB device), your PC's characteristics, as well as which software you're running. The use of plug-ins can also increase latency, some more than others.

Consider what happens when you are working at your DAW. As you play your tracks, a constant stream of data passes from your hard disk and/or RAM to your sound card. Amongst other things, this converts the digital data to an analog form, so that it can be sent to, and heard thru, your speakers or headphones. When you record the reverse happens – the incoming analog audio stream has to be converted to a digital format.

During overdubbing both of these activities happen at once. With input monitoring, the track(s) being recorded are actually being fed into the computer in analog form, converted to digital, processed, then converted back to analog again as they are fed back to your headphones. Latency is a measure of this delay. Incidentally, you can make this activity easier if your audio device itself supports input monitoring. In this case, the incoming audio stream that is being recorded is fed straight back into your headphones before it even gets into the computer.

As if this wasn't complicated enough, remember that your Mac or Windows computer is performing all sorts of other tasks at the same time as you are recording. Windows users, for example, can view their Task Manager and check the **Processes** page to have a look. That's what we mean by **multitasking**.

REAPER's Preferences and Other Settings

So how is Windows able to keep up with its other 99 or so tasks at the same time as handling your recording? It does so by dividing its resources between all the tasks at hand. In order to maintain a constant audio stream, small amounts of memory are allocated to storing this audio stream. These areas are called buffers.

Thus, as you play back your audio, Windows hands over to your sound card a block of audio that the sound card releases at a steady rate to your external amplifier. If it empties these buffers before Windows gets round to handing it some more, then you've got a problem. The same principle applies, but in the reverse direction, when you're recording. And again, when you're layering or overdubbing, or using REAPER's input monitoring, both activities are going on at the same time.

If the buffers are too small, you'll get gaps in the audio stream. These can lead to pops, crackles and in some cases even dropouts (that's when playback and/or recording just stops suddenly and unexpectedly). Making buffers larger is usually enough to fix this problem, but it brings with it another. Make them too large, and the data at the end of the buffer has a long wait before it is processed. That's when you experience unacceptably large latency, such as the delay between pressing a keyboard and hearing the note in your headphones.

The macOS uses CoreAudio to manage these issues. PC users, on the other hand, are faced with a possibly confusing choice as to which drivers to use.

ASIO drivers generally offer better latency than others. As a rule, the preferred order is ASIO, WDM, DirectX and MME, in that order. This is where the **ASIO Configuration** button on the **Audio Device** screen is so important (assuming, of course that you are using ASIO drivers). It opens the audio settings screen for your soundcard.

Shown below is an example of the settings page for one particular external soundcard. It is only an example - don't expect yours to look identical, although it is likely to contain similar settings (sample rate, buffer size, etc.)

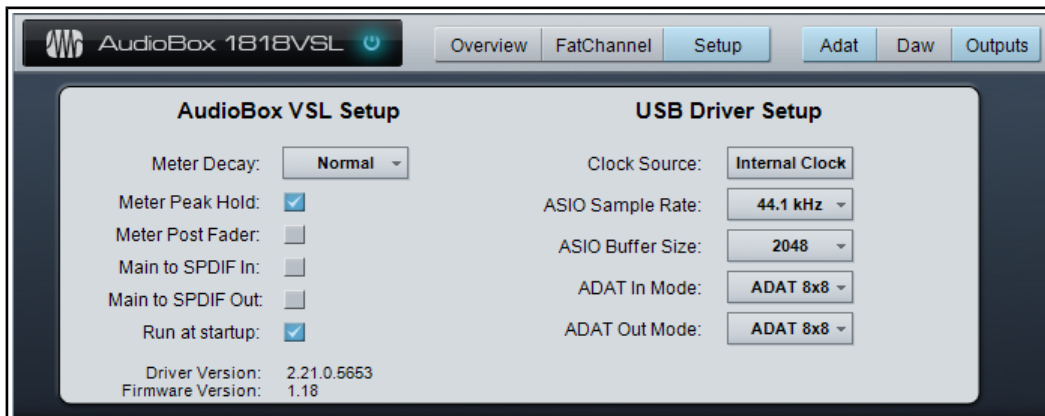

The smaller the buffer size, the greater the load on your computer's CPU.

So after making changes to your buffer size, check the CPU usage on REAPER's Performance Meter. You can use this fact to your advantage when mixing.

As a rule, low levels of latency are only really needed for recording, not when you are only playing audio back. Therefore, if you find that you are pushing your CPU close to its limits, you will often be able to fix this by accessing your audio card's control software and increasing the buffer size.

Sample Rate also affects CPU usage. Going from 44100 to 88200 doubles CPU usage.

This is an area about which there is much debate, but in reality few of us have ears that can really detect whether a track has been recorded at 44100 or at 88200. Test this out for yourself and see what you think.

Check also your **MIDI Devices** settings preferences. This has been covered in Chapter 1.

22.5 Audio Glitches and Related Issues

Still getting audio performance issues? The problems could lie in your Windows settings. For more information about this, see this page on the Native Instruments web site:

<https://support.native-instruments.com/hc/en-us/articles/209571729-Windows-Tuning-Tips-for-Audio-Processing>

A more comprehensive free book on optimizing audio performance can be downloaded here:

<https://www.cantabilesoftware.com/glitchfree/>

22.6 Audio Preferences

Many of these are advanced options: if unsure, leave at their default settings.

- Whether to **Close audio device when stopped and application inactive**. Enable this to allow other programs to be open at the same time as REAPER, and to be able to switch between them.
- **Close audio device when inactive and tracks are record armed**. Enable this to allow REAPER to share your audio device with other programs when you have record armed tracks.
- An option to **Close audio device when inactive and REWIRE devices are open**.
- **Close audio device when stopped and active**. If enabled, REAPER will automatically close audio devices when audio is not being played back.
- Enabling **Warn when unable to open audio/MIDI devices** and **Warn when enabled MIDI devices are not present** could potentially help you to troubleshoot if you encounter hardware interface issues.
- An option to **Temporarily bypass oversampling on record arm affected tracks**.
- An option to **Auto bypass FX even when FX configuration is open** (see tooltip for more info).
- An option to **Stop processing audio** in the event of **disk failure/disk full**.
 - An option to specify a **Virtual loopback audio hardware** setting (see tooltip for more info).
- **Input/Output Channel naming/mapping** and **Non standard stereo channel pairs**. These features let you give meaningful names to your audio input and output devices. It is [explained in detail](#) in Chapter 1.
- Output to be used for **Metronome Output**.

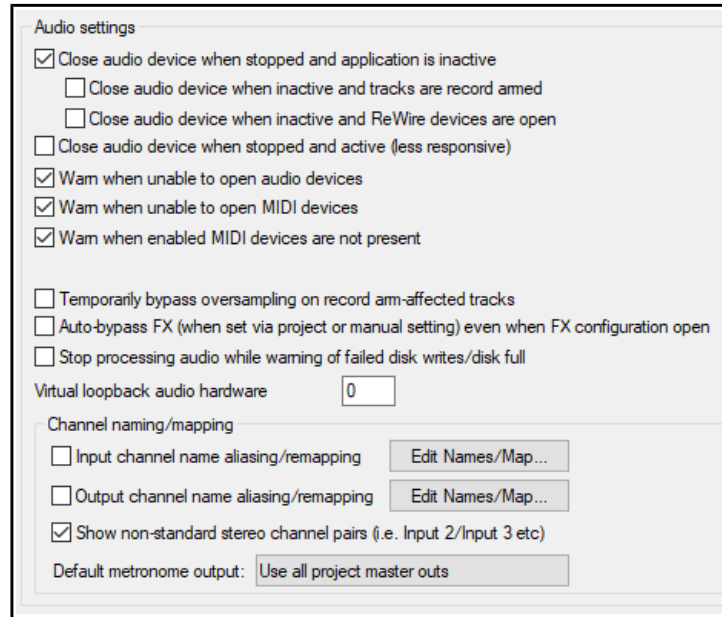

Note that [Audio, Device](#) preferences and settings are explained in Chapter 1.12 and [Audio, MIDI Device](#) preferences and settings in Chapter 1.15.

22.6.1 Audio, Mute/Solo

- You can **Automatically mute any track** or the **Master track** when a specified dB limit is reached, or specify **No automatic muting**. You can also **Reset** (clear auto mutes) on playback.
- Enabling **Do not process muted tracks** and/or **Reduce CPU use of silent tracks during playback** could lessen the load on your CPU.
- You can specify that **Pre-fader sends** to either another track or direct to any hardware outputs will function **regardless of whether or not the track has been muted**.
- **Solos defaults to in-place solo**. If enabled, a soloed track will be heard along with the audio output of any other tracks with receives from that track. Disabling this ensures that you will hear only the soloed track. In either event, holding **Alt** while clicking solo will reverse your default option.
- **Solo in front** plays other tracks in background when one or more tracks are soloed. This may help you to place more in context the track that is being auditioned. The feature itself is enabled/disabled from the **Options** menu: in your preferences you can set your preferred dB level for the background material.
- You can ensure the **Master/parent send is unsoloed when a soloed in place track sends to another soloed track**.

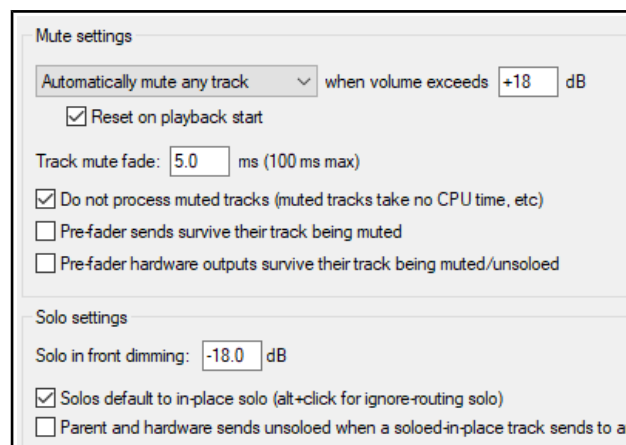

REAPER's Preferences and Other Settings

22.6.2 Audio, Buffering

Many users will be able to ignore these settings and leave them at their defaults.

The option **Disable media buffering for tracks that are selected** can be useful if using a third party plug-in that does not respond well to buffering. If you are not technically minded you should leave most of these settings at their default values. For computers with two or more processors, these options might be useful.

Anticipative FX processing On single processors it makes REAPER more tolerant of lower interface latencies (and more resistant to plug-ins that do larger block-based processing, such as ReaVerb and ReaFir). On multiprocessor/ multicore systems it also allows for very significant multiprocessor usage. Enabling this feature can allow improved latency.

Options include to allow on tracks without FX, when a MIDI editor is open and on tracks in touch/latch/write automation modes. However, **allowing FX multiprocessing** when a MIDI editor is open will increase preview latency.

Clicking on **Advanced Disk I/O Options** brings up the selection of options shown on the right.

If unsure about what you are doing, it's better to leave these settings at their defaults. Any changes you do make should not come into effect until after closing and reopening your project file.

22.6.3 Audio, Seeking

- **Seek playback** (repositioning the play cursor) when clicking on any of the top ruler, empty areas of tracks, empty areas below tracks, and/or media items when moving cursor. Disabling any of these will enable you to click or click and drag in arrange view (for example, on the ruler to define a loop, or in the empty area between tracks to define a time selection) without affecting existing playback.
- **Seek playback when loop points are changed** and/or **Only when repeat is enabled**.
- **Seek playback when an item is moved/sized or has its fade adjusted**.
- Specify playback position should **follow the project timebase when changing tempo**.
- **Smooth seek**: this lets playback go on to the end of a defined number of measures, or to the next marker or end of region, before seeking. This can be toggled on / off via REAPER's main **Options** menu.

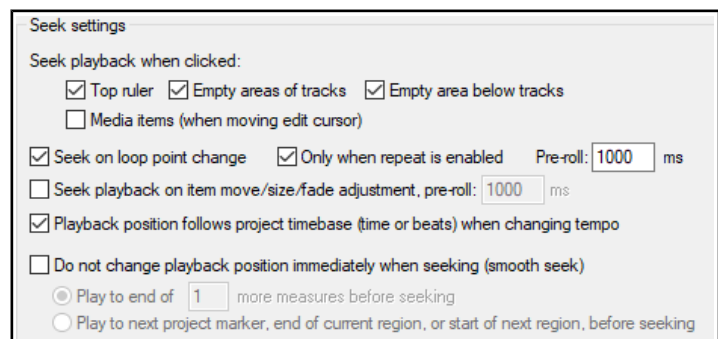
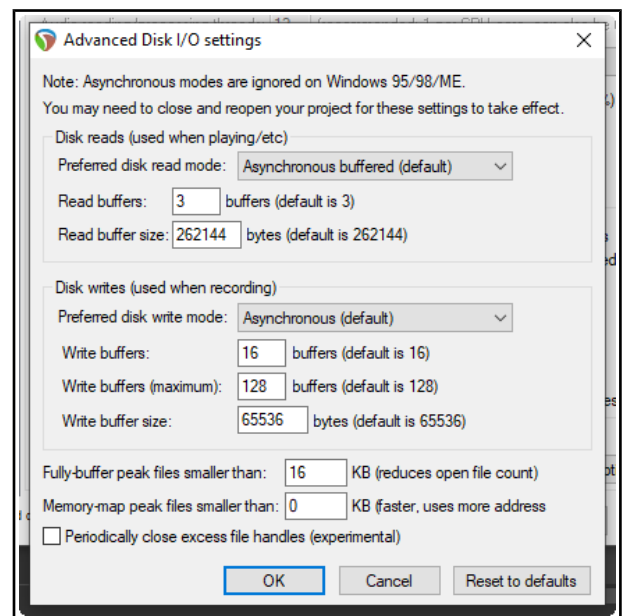
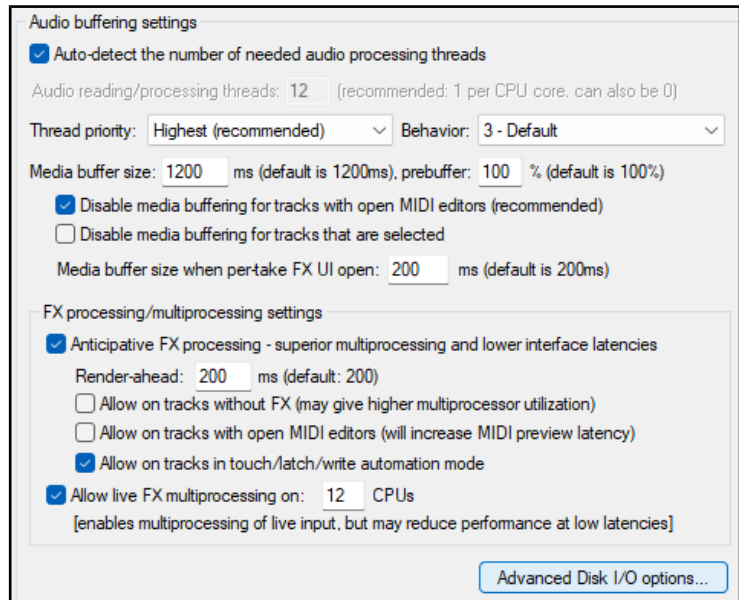

22.6.4 Audio, Playback

Options include whether or not to:

- **Stop/repeat playback at end.**
- **Stop playback at the end of a loop** if repeat is disabled.
- **Scroll the view to the edit cursor position when stopped.**
- Specify **Max MIDI playback speed when negative offset is applied.**
- **Flush FX when looping.**
- **Run FX when stopped:** helps evaluate the "after effect" of reverb, chorus, etc.
- How long to **Run FX on Stop.**
- **Insert tiny fades on playback stop** and/or **On playback start.**
- **Reduce mixing CPU use of silent tracks during playback.**
- **Send MIDI note-offs when un-record-arming a track.**
- **Reset MIDI CC/Pitch** on playback start and/or playback stop and/or playback loop/skip. Includes **CC reset overrides** option.

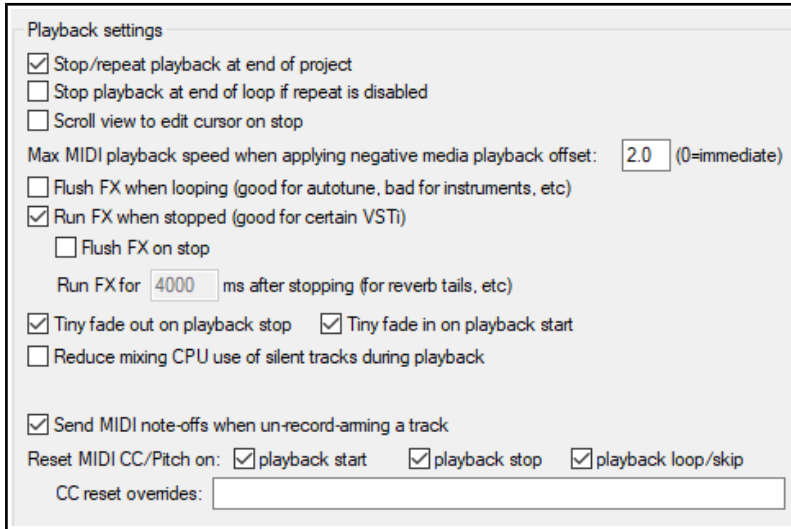

Note that there is also a command on the **Options** menu to enable/disable **Continuous scrolling**.

22.6.5 Audio, Scrub/Jog

Scrubbing/jogging options include whether to:

- **Only play selected tracks when scrubbing/jogging.**
- **Scrub/jog when moving edit cursor via action or control surface** (requires mouse behavior to be set in **Editing behavior/Mouse modifiers**).
- **Set maximum jog rate.**
- **Limit jog rate when near cursor.**
- **Limit scrub rate to 1.0.**
- **Engage scrub when playing.**
- Set speed for **Looped segment mode.**
- **Scrub-mode controller sensitivity.**
- **Scrub/jog volume gain** (if any)

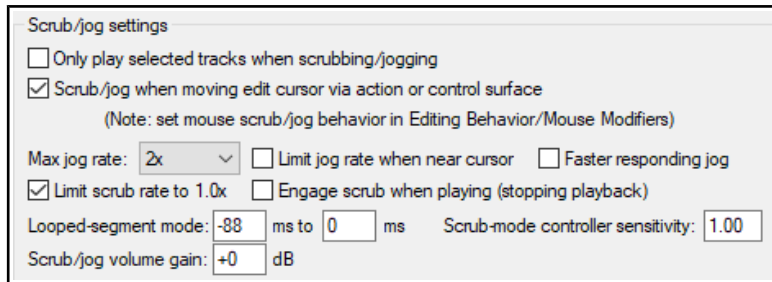

Remember that you can hover your mouse over any of these options to view further information!

22.6.6 Audio, Recording

Audio Recording preferences are detailed and explained in Chapter 3.

22.6.7 Audio, Loop/Lane Recording

This page of settings determines how REAPER behaves when loop recording.

- **Discard incomplete first or last takes if at least one full loop was recorded.** Prevents unwanted partial takes being saved, as might happen if you are a tad slow in stopping recording.
- You can define at what **threshold** (default 90% of loop length) the recording should be considered to be complete.
- Whether **MIDI overdub/replace recording should always creates selection-length media item.** Enable this to ensure MIDI media item matches time selection length.

REAPER's Preferences and Other Settings

- When you are recording and looped, to add recorded media to the project under which of the following circumstances:

On stop (recommended, optionally **Creating new files on loop**), or **At each loop** (good for recording multiple layers on the fly).

- When recording into fixed lane tracks whether to always record into an existing lane if space.
- Optionally, when recording into fixed lane tracks whether to add whole recording whether or not comping.

22.6.8 Audio, Rendering

If unsure, leave at their system defaults.

- **Block size** to use when rendering samples. If in doubt, leave blank. Other options are whether to:
- **Allow anticipative FX processing**: may improve multiprocessing performance.
- **Limit apply FX/Render stems to realtime** (default is off).
- **Process all tracks** (including muted tracks). Likely to make rendering slower.
- Disable FX auto-bypass when using offline rendering, applying FX, or stem rendering.
- Specify FX tail length when rendering entire project and/or time selection/ regions, and/or selected media items.
- When freezing, whether to render entire track length if there are FX whether to include reverb tails.
- Option to freeze muted items into silent muted items.
- Option to mark overs in render peaks display.
- Option to enable/disable automatic close of render window when done.
- **Render display and statistics** Choose what information is calculated and displayed when a **dry run render** is performed.
- Whether to **reopen render results window modelessly to allow focus to return to project**.

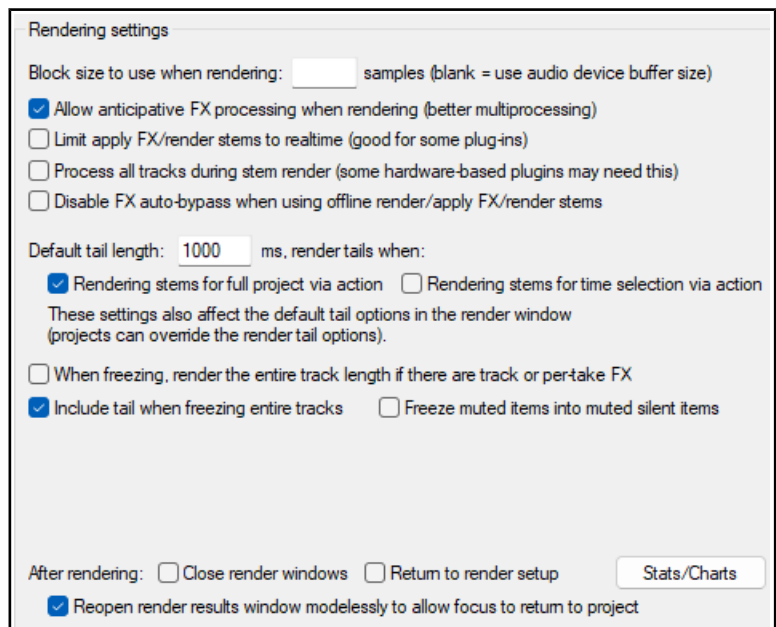
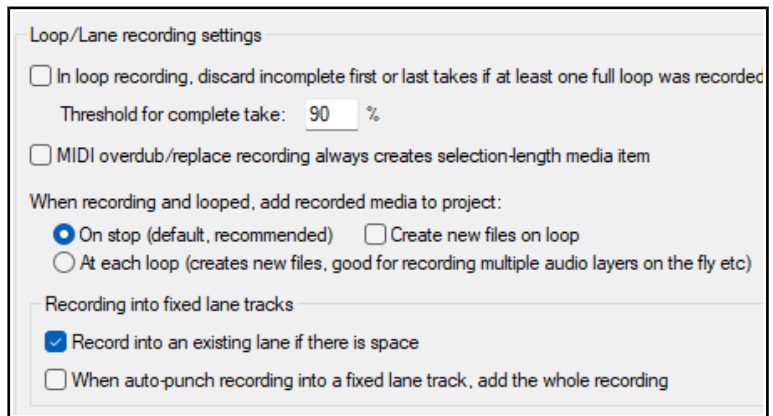

22.7 Appearance Preferences

The **Appearance** page lets you customise the look of your REAPER interface in arrange view. Settings include:

- To use **tooltips for UI elements** such as buttons and faders, media items and envelopes, etc.: specify any delay to precede the tooltip being displayed.
- To **show peak and loudness values** when mouse is over a media item.
- To use **faster text rendering**.
- To **draw vertical text bottom up**.
- To display **floating toolbar windows** with or without **frames**.
- To **limit the scaling of toolbar buttons**. Enabling both these options will prevent the buttons from becoming smaller or larger if you resize the main or floating toolbar.

For a bound hard copy of the latest version of this User Guide (printed in B&W) go to LULU.com

- To **Animate armed toolbar buttons or any toolbar buttons.**
- **Vertical space between adjacent tracks and Vertical track spacer size.**
- To use **antialiased fades and envelopes.**
- To **show horizontal grid lines** in automation lanes.
- To display **filled automation envelopes**, including **When drawn over media**: enabled, these color the area below the envelope.
- Set **scaling for envelope points** when envelope is or is not selected.
- To **Highlight the edit cursor over the last selected track.**
- To **show guidelines when editing.**
- To **apply solid edges** to time selection highlights. and/or **loop selection.**
- To **display vertical line at mouse cursor position**, snapped, unsnapped or managed by control and/or shift key.
- **Play cursor width.** Default setting is 2 pixels.

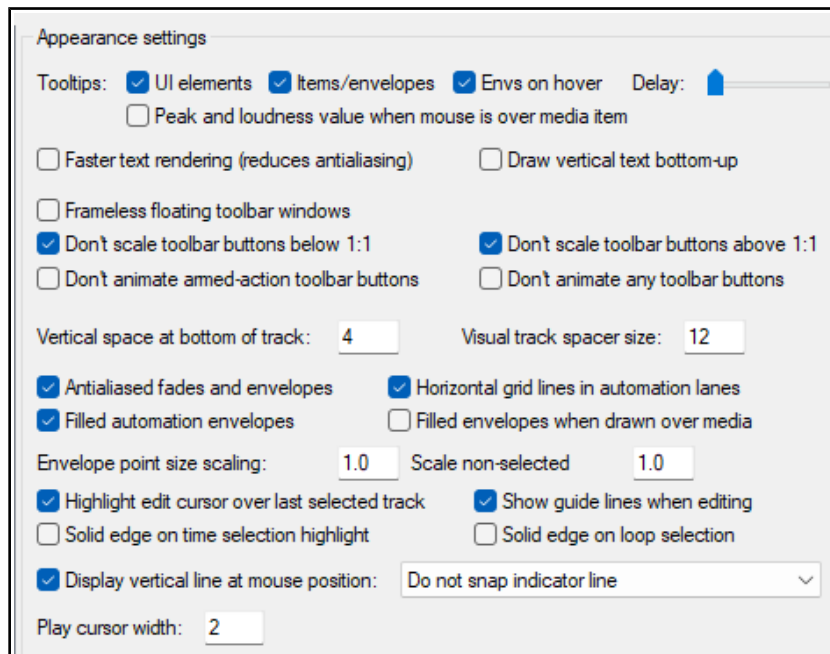

22.7.1 Appearance, Ruler/Grid

- **Ruler label spacing:** adjust the slider to determine the number of increments used for ruler display.
- To show ruler markings for all fractional beats as (X/Y).
- To display ruler markings for triplets as (X/Y).
- To show **grid lines** over, through, or under items.
- To show **marker lines** over, through, or under items.
- To show **dotted grid lines.**
- To show **project regions/markers in arrange.**
- To show **time signature changes in arrange.**
- To show **marker lines** over, through or under items.
- To **divide arrange view vertically when ruler displays time, frames or samples** and, optionally whether to **Shade every xx measures.**
- To **divide arrange view vertically when ruler displays beats** and, optionally, and optionally whether to **Shade every xx measures.**

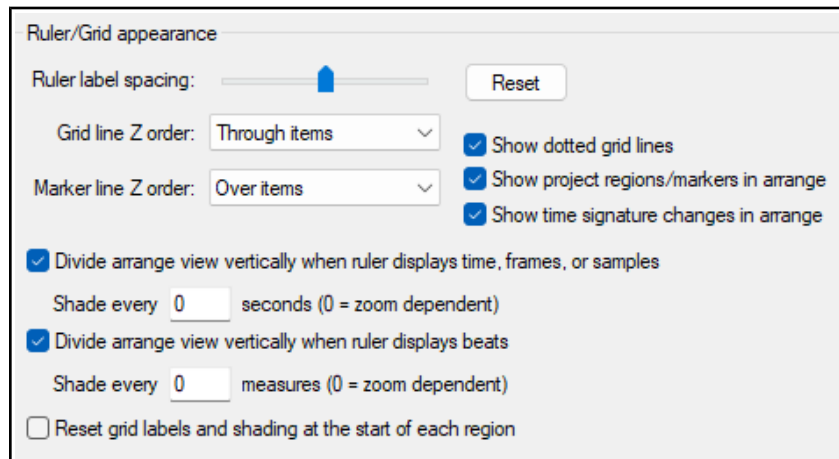

REAPER's Preferences and Other Settings

22.7.2 Appearance, Media

For the most part these fall into two main groups – **Media item labels** and **Media item buttons**.

Media item labels: Whether to **display item take names** and/or **media item pitch/play rate** and/or **gain** (if set)

Whether to **draw labels over solid background for easier reading** and whether to **show labels when item edges are not visible**.

You can then choose whether to **draw labels above** (rather than within) **the item** when the media item height exceeds a specified number of pixels. **Item take pitch rate** display can be as normal labels, abbreviated, or numbers only.

Enabling **Draw selection indicator on items** causes selected items to be marked with a small white dot. Maximum stretch marker handle size can be specified, either in pixels or as a percentage of the take height.

Regardless of your preferences settings here, the label will not be displayed if the item height is not tall enough.

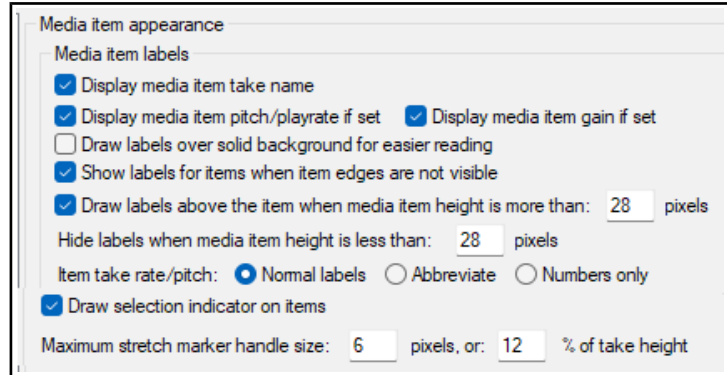

22.7.3 Appearance, Media Item Buttons

Mostly these are paired – **Locked/Not locked**, **Muted/Not muted**, **Per take FX/No FX**, **Automation envelopes/No active envelopes**, **Notes/No notes**.

There are also buttons for **Item Properties**, **Item properties only if resampled media**, **Item properties if phase is inverted**, **Pooled MIDI**, **Grouped items**, **Item volume knob**.

Any of these can be displayed above your media items. You can also specify **Hide buttons when take lane height is less than xx pixels**.

An **Item volume control handle** can be displayed. The default is **No handle**, but you can choose to display this either at the top of the item or in the centre of the item.

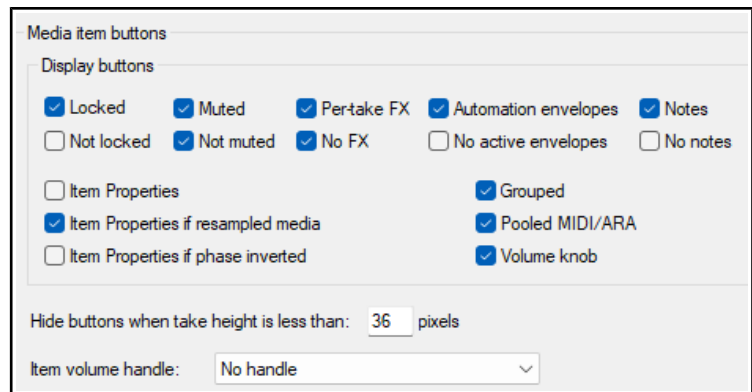

22.7.4 Appearance, Peaks/Waveforms

These settings define the look of your audio peaks and waveforms.

You can specify whether to **Display peaks for media items** and/or **Display peaks while recording**. Optionally, you can specify a **minimum height**, below which peaks will not be shown.

Options to show peaks **Only display peaks for selected tracks** and **Only display peaks for tracks that are soloed or not muted**.

Sample view for zoomed in audio can be set to **Dots and lines**, **Filled**, **Outlined** or **Stepped samples**, **Smooth**, **Sinc smooth** or **Dots and sinc**.

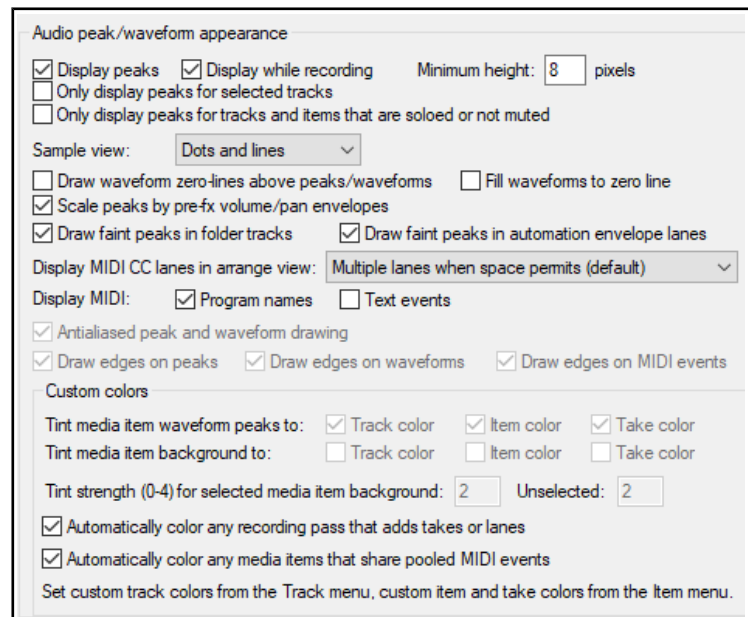

Up and Running: A REAPER User Guide v 7.31

Other options are **Draw waveform zero lines above peaks/waveforms** and **Fill waveforms to zero line**. You can **Scale peaks to pre-FX volume/pan envelopes**.

Enabling **Draw faint peaks in folder tracks** allows the output of a folder's child tracks to be displayed as waveforms in arrange view. You can also **Draw faint peaks in automation envelope lanes**.

You set MIDI CC lanes in MIDI tracks in arrange view to **Do not display CC data, Only the first lane visible in MIDI editor, One lane combining all CC data, or Multiple lanes when space permits (default)**.

You may also choose to display **program names** and/or **text events** in arrange view.

Anti aliasing is a technical issue. Google to learn more, but, in short, enabling antialiasing may give you a more accurate representation: disabling it may cause your peaks to be drawn/redrawn more quickly.

The **edges** options are cosmetic. Enable them, for example, if you like your peaks bordered when using custom colors, disable them if you don't. *These options are disabled by some themes.* See [Chapter 11](#) for more information.

Automatically scale MIDI notes and/or **drum MIDI** will fit the item as displayed in arrange view.

Custom Colors. There are options to **Tint media item waveform peaks** or **Tint item background** to any of **Track Color, Item Color** or **Take Color**.

If more than one option is enabled, then the lowest level has precedence – e.g. take color wins over item and track color. *Some themes disable this group of options.*

You can set **tint strength** for media item backgrounds within a range of 0 to 4, where 2 is the system default.

Also in this section is the option **Automatically color any recording pass that adds takes to existing media items**. This can help to give a clearer picture when you are working with multiple takes.

Remember that you can **set custom colors from the Track menu, custom item and take colors from the Item menu**. And hover your mouse over any option for further information (if available).

22.7.5 Appearance, Fades/Crossfades

These options give you control over media item fades and crossfades. You can:

- Set a minimum item **width** and/or **height** for a fade to be editable.
- **Enable or disable mouse editing** of fade curves and/or fade starts/ends.
- Decide when to display **fade** and **crossfade editing handles**.
- Indicate whether you want to use **crossfade editor theme colors**.

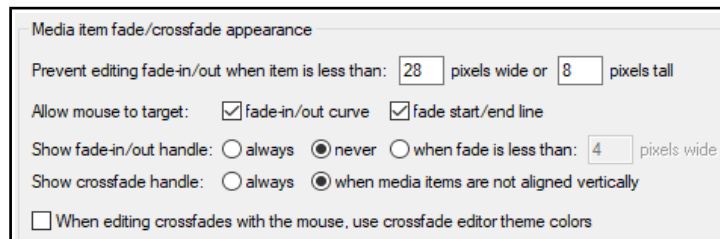

22.7.6 Appearance, Zoom/Scroll/Offset

Options are:

- **Set vertical zoom center** to Track at view center, top of view, last selected track or track under mouse.
- Specify **Max vertical zoom % of arrange view height** and **Envelope lane vertical zoom % of track height**.
- **Set horizontal zoom center** to Edit or play cursor, Edit cursor, Center of view or mouse cursor.
- **Set vertical scroll limits** relative to track height.
- **When project settings enabled to offset overlapping media vertically** by what percent of item height to offset, whether to draw as opaque.
- Whether to **arrange overlapping media items in the order they were created**.

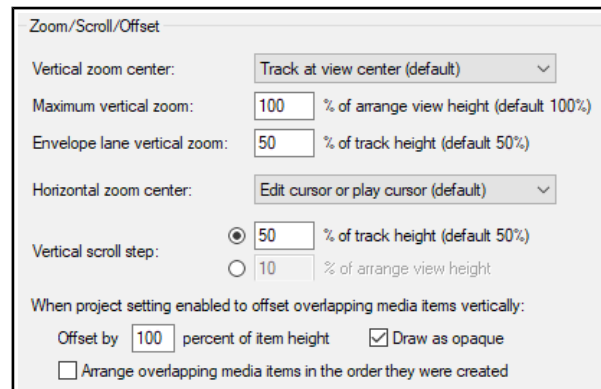

REAPER's Preferences and Other Settings

22.7.7 Appearance, Track Control Panels

Track control panel settings include:

- Whether to **use custom track colors** as a background color on track labels (in TCP and mixer) and to **tint track panels** (in TCP and mixer). *These options are disabled by some themes. See [Chapter 11](#) for more info.*
- Whether to adjust the alignment of **TCP controls** when track icons or fixed item lanes are used.
- Whether to use **track grouping indicators** (ribbons or lines).
- **When cycling thru folder collapse button** select permutation of normal, small, collapsed or hidden to use.
- Set default click/shift click behavior for fixed lane collapse button – **big/small** or **one/many**.

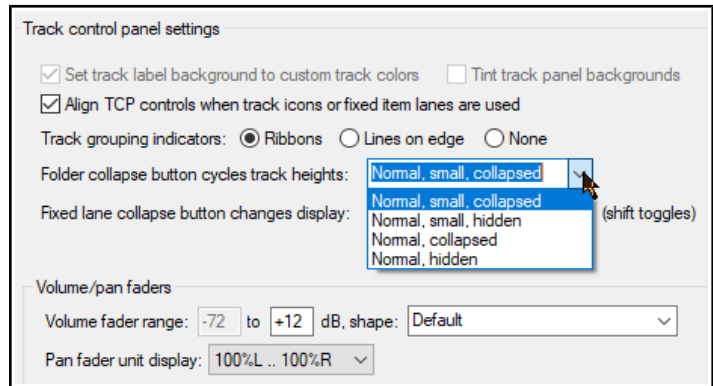

The final options are **fader** options which can be used to restrict the adjustable **range** of your volume and/or pan faders. The top of the **volume** range can be set to 0dB or higher. There is also a drop-down box of **volume fader shape** options: for example, if you set this to 1.0 the fader becomes a log curve, so that linear movement produces a constant dB curve.

You can also display **pan fader units** either as ranging from 100%L to 100%R or from -90 dB to +90 dB.

22.7.8 Appearance, Track Meters

These options will determine various aspects of your track panel meters appearance and behavior.

- **Meter update frequency:** determines the meter refresh rate, measured in Hz. The higher the value, the more frequent the updates.
- **Meter decay:** determines the rate at which the meter display will decay, measured in dB/sec. The higher the value, the faster the meters will decay.
- **Meter minimum value:** determines the lowest value metered, in dB.
- **Meter maximum value:** determines the highest value metered, in dB.
- **Scale gain reduction from plugins:** Gain reduction from a plug-in that passes to the host will be displayed in the track meter.
- **Show track input when track is armed:** shows the recording source when the track is armed.
- **Make obvious that track is clickable:** draws a faint box around recording source name.
- **Show dB scales on track meters:** dB scale will be marked on your track VU meters.
- **Show dB scales on rec armed track meters:** dB scale will be marked on meters.
- **Show MIDI velocity on track meters:** when MIDI velocity is present this will be indicated by a thin line.
- **Show MIDI output on track meters:** shown as a thin line for velocity and a small square for others .
- **Sticky clip indicators:** enabled this ensures that peaks on the VU meter are marked with a bar for a few moments after they have passed.
- **Track meters display pre-fader levels:** fader setting will not affect meter display.

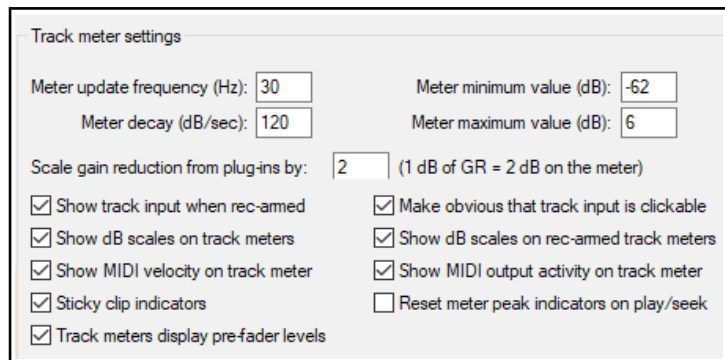

22.7.9 Appearance, Envelope Color Overrides

In this window you can define your own rules for coloring automation envelopes. See [Automation and Envelope Tips](#) in Chapter 19.

22.8 Editing Behavior Preferences

The **Editing Behavior** page of **Options, Preferences** (shown here) includes a number of areas in which you can specify default settings in a range of matters that will affect how you work when editing your REAPER projects. Here is a summary of some of the most useful options:

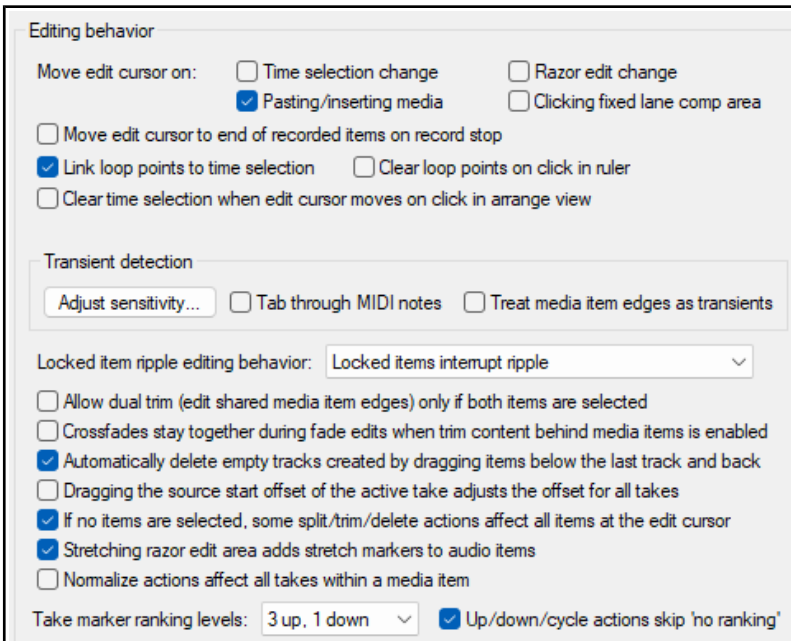

- Specify your **edit cursor behavior**, in particular which of the following actions should cause the edit cursor to be moved: Changing time selection, Pasting/inserting media, and/or Stopping recording.
- Specify whether or not to **Move edit cursor on razor edit change**.
- By default link (or unlink) **time selection and loop points**.
- Enable or disable the ability for **loop points to be cleared by clicking on the ruler**, and/or **time selection to be cleared by clicking in arrange view**. For example, if you want to click on the ruler as a means of repositioning the edit cursor then you probably won't want loop points automatically cleared.
- **Adjust tab sensitivity of transient detection**, both percentage sensitivity and dB threshold. Click on **Adjust sensitivity** to access the options in the **Transient detection settings** dialog (below right).
- You can also specify whether to **Tab thru MIDI notes** and/or **Treat media item edges as transients**.
- How REAPER should behave when locked items are included in a ripple editing selection. Options are **Locked items interrupt ripple** (ripple edit interrupted at first locked item but can be completed by repeating the action as often as required to choose which items are ripple edited), **Locked items interrupt ripple per-track** (similar but on a per track rather than per item basis), **Locked items unaffected by ripple** (these are edited normally but other items are ripple edited), or **Locked items are affected by ripple (lock ignored)** (all items in selection are ripple edited, including locked items).
- Whether to allow **dual trim options** shared media item edges only if both items are selected.
- Whether **crossfades** should **stay together** during fade edits.
- Whether to **automatically delete empty tracks** created when dragging items below last track.
- Whether **dragging the source start offset** of the active take should adjust the offset of all takes.
- Whether to **split/trim/delete all items at edit cursor** if splitting/trimming/deleting with no items selected. Disabling this will prevent, for example, all items being split if you press **S** with no item selected.
- Whether to **add stretch markers** to audio items when stretching razor edit area.
- Whether **Normalize actions affect all takes within a media item**.
- Specify number of **take marker up/down-rank** levels.

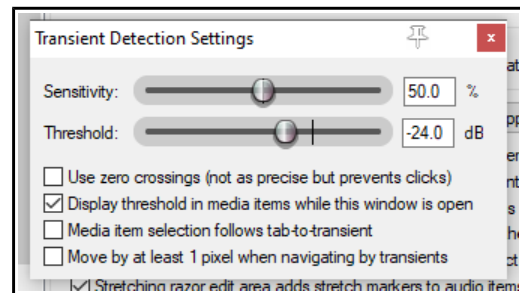

REAPER's Preferences and Other Settings

22.8.1 Editing Behavior, Envelope Display

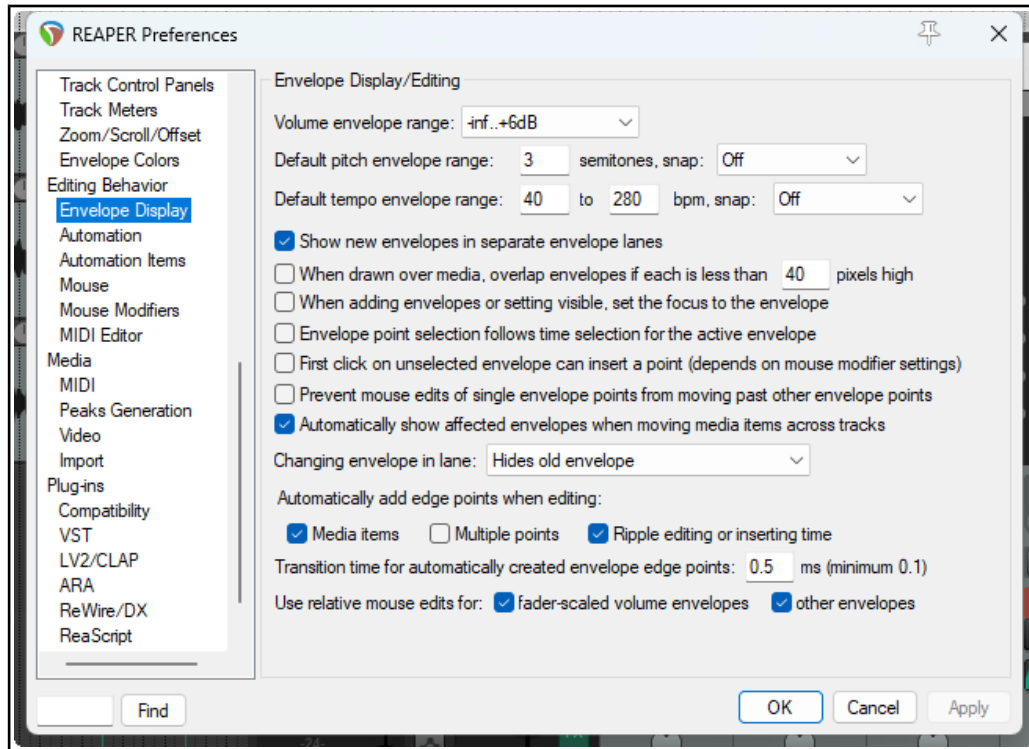

- Select the default **range** within which **volume** envelopes can be adjusted. Options range from **-inf...+0dB** up to **-inf...+24dB**.
- Specify a semitone range for per take pitch envelopes, also whether or not to snap.
- Specify a display range (beats per minute) for the master **project tempo map envelope**.
- Whether to enable **snap**, and if so, to whole or fractional bpm.
- Whether or not to **Show new envelopes in separate envelope lanes** by default.
- When drawn over media, overlap envelopes if each is less than x pixels high. Enabling this option may create a more cluttered visual effect, but it will allow more height for editing envelope points.
- Whether to **set the focus to new** envelopes as they are added. This automatically selects them for editing, etc.
- Whether **envelope points** are also selected with a **time selection**.
- Whether the **first click on an unselected envelope** will insert a point: check also mouse modifier settings.
- Whether to add a **transition point** on stopping playback after recording automation.
- Whether to **Prevent mouse edits of single envelope points from moving past other points**.
- Whether or not to **Automatically show affected envelopes when moving data across tracks**. Showing these can sometimes be visually confusing.
- Whether **Changing the envelope shown in any lane** should cause the envelope previously there to be hidden or moved to the media lane.
- Whether **edge points** (at start and end of time selection) are added to envelopes when media items are edited, and/or when multiple points are edited, and/or when ripple editing or inserting time.
- You can also specify a required **transition time** for automatically created envelope edge points. A longer setting can create a smoother transition.
- Whether to use **relative mouse edits** for **fader scaled volume envelopes** only, or also for **other envelopes**. Note that relative mouse edits provide more Y-axis resolution, at the expense of the envelope points not following the mouse cursor.

22.8.2 Editing Behavior, Automation

- Set **automation recording return speed** and **action transition time**: for envelope returning to its previous value when using actions to write envelope changes
- Whether to **Automatically add envelopes** when you adjust any parameters in write mode. You will not be able to adjust any parameters in write mode without creating envelopes.
- For **hidden envelopes**, whether to **display read automation feedback** and/or **allow writing automation**. In read mode allows (for example) a volume fader on even a hidden envelope to move with changes in volume,. **Allow writing automation** to hidden envelopes can risk making accidental changes to envelopes.
- Whether to **reduce envelope point data** when recording or drawing automation. Not enabling this can lead to more points being created than you might like.
- When recording automation in playback **whether to record at playback or processing position**.
- When recording automation stops, whether to **add an additional point before the edit position, before and after** the edit position, or **not at all**.
- **When pan/volume envelopes are added, whether trim is reset** when the envelope is drawn. Options are Always, In read/write mode only, or Never. Setting this to Never may make the manual editing of such envelopes easier (by leaving you plenty of room both above and below the envelope).
- Whether to **Automatically remove envelopes when hiding and containing only a single point**.
- Which envelopes to target if **both pre fx and post fx volume/pan/width envelopes are armed**.
- **After recording automation in write mode whether to automatically switch to one of the other modes**. The trim/read option is handy if you are inclined to forget to do this manually!
- Whether **latch mode envelopes** should be reset to their initial states when looping during playback.
- Whether to **unselect envelope** on various **mouse clicks**.

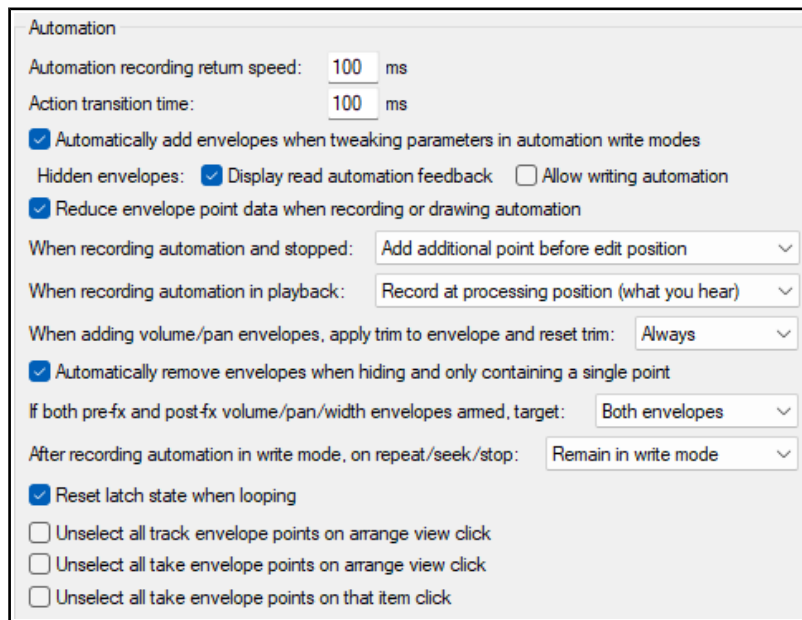

22.8.3 Editing Behavior, Automation Items

- Whether to **Always record to automation items** and/or to **Record to existing non-selected automation items**.
- Whether **new automation items** should be **looped by default**, whether **editing baseline/ amplitude in properties dialog affects pooled copies**, and whether to **Pool source data when pasting automation items**.
- Whether to pool source data **When copied and/or split by track/item razor edits**.
- Whether to **Trim content behind automation items when editing**.
- Option to **set default edge transition time for new automation items** (max 200 ms).
- Whether to **automatically append envelope name to automation item label**.

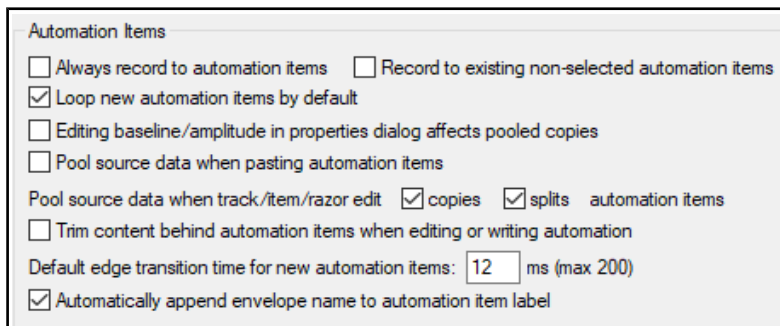

REAPER's Preferences and Other Settings

22.8.4 Editing Behavior, Fixed Lane Comping

- Whether to allow **Media item edits in comping lane to expand media items in source lane.**
- Whether to **Avoid comping empty track space when clicking source lane** and/or **Editing comp area edge.**
- Whether **Comping MIDI items creates pooled copies.**

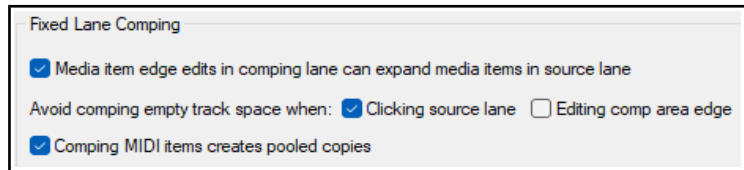

22.8.5 Editing Behavior, Mouse Editing Behavior

- **Mousewheel targets:** whether mousewheel acts on the window currently underneath the mouse or on the last window to have focus. Lets you to use adjust the parameters of an open FX window without having to click on the window to get focus. Focus can remain with your mixer, or arrange view, or wherever you were before.
- Whether to **Ignore the mousewheel on all faders.** Disable this or either of the next two options to use your mousewheel to adjust faders on the TCP and/or the transport bar and/or FX controls.

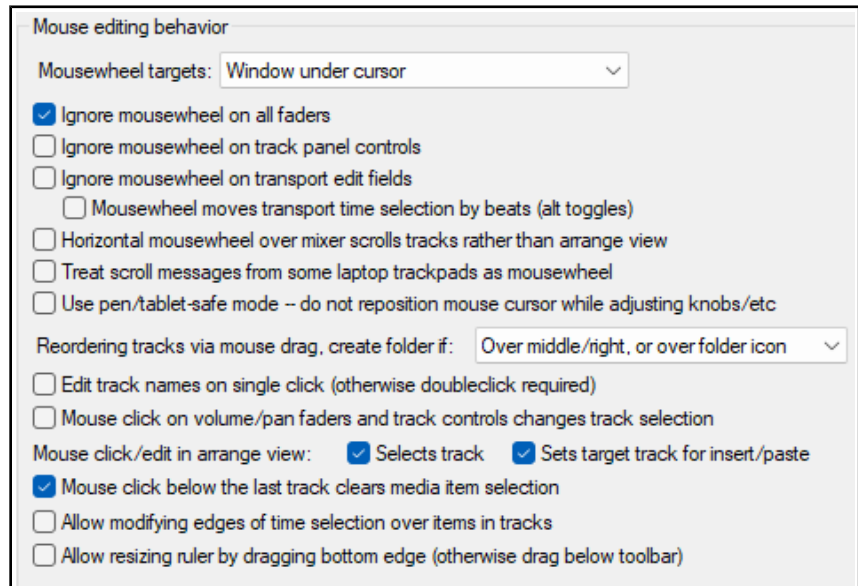

- Whether to **Ignore the mousewheel on track panel faders.**
- Whether to **Ignore the mousewheel over transport edit fields.** If disabled, you can edit text fields such as BPM and play rate just by scrolling your mousewheel over the field. There is also an option to use the mousewheel to **adjust transport time by beats.**
- Whether **Horizontal mousewheel over the mixer scrolls tracks rather than arrange view.**
- Whether to treat scrolling a **laptop trackpad** as being like using a mousewheel.
- Option to **Use pen/tablet safe mode** so as not to reposition mouse cursor when adjusting knobs, etc.
- **When reordering tracks via drag and drop, hold shift key to control folder creation.** If enabled, dragged track will be inserted in folder when dropped.
- Whether **Mouse click on track fader or button** causes that track to become the currently selected track. Disabling this allows you to adjust track faders, etc. without changing the track selection.
- Whether to require a **single** click or a **double** click when **editing track names.**
- Whether **Mouse click/edit in arrange view changes the track selection** and/or **Sets track as the target for insert/paste.** Enabling the former will ensure that track selection will follow media item selection.
- Whether to **Allow modifying edges of time selection over items in tracks.** Lets you click and drag over a track (or between tracks) to adjust start or end of a time selection without affecting item selection.
- **Allow resizing ruler by dragging bottom edge.** Disable this if you do not want to allow the height of the ruler area to be manually resized.
- In addition, for **MacOS** users on a Mac, there is an option **Ctrl left click emulates right click.** However, it is a better practice to use your System Preferences to enable right-clicking.

Mouse Modifiers: The topic of [Mouse Modifier](#) preferences is covered in Chapter 15 and elsewhere.

22.8.6 Editing Preferences, MIDI Editor

Options are:

- **Flash MIDI editor keys on track input:** if enabled, causes a brief color flash to be displayed on the MIDI editor keyboard when the track receives MIDI note-on input.
- **Horizontal grid lines in CC lanes:** toggles the option to show horizontal grid lines on and off.
- **Events per quarter note when drawing in CC lanes.** Specific event density or zoom dependent.
- **Default shape for CC segments:** square, linear, slow start/end, fast start, fast end or bezier: also whether to **Reduce number of CC events when drawing.**
- Whether to **Display empty space at top/bottom of CC lanes.**
- **Prevent mouse edits of single events from moving past other CC events.**
- **One MIDI editor per ...** Select whether a separate MIDI editor instance is required for each item, or for each track, or one instance for the entire project. Depending on your choice you may have other options.
- Default **Behavior for open items in built-in MIDI editor:**
- If **One MIDI editor per project** is selected, specify whether to open **clicked item only**, **all selected MIDI items**, **all MIDI items on the same track** or **all MIDI items in the project**.
 - You also have three more toggle options. These are:
 - Whether **Active MIDI item follows selection change in arrange view**. This can be on a **per media item** or **per track** basis.
 - Whether **Media item selection is linked to visibility** and/or **Selection is linked to editability**.
 - Whether to **Close MIDI editor when the active item is deleted in arrange view**.
 - Whether **All MIDI items should be editable by default if they are visible in editor**.
 - Whether to **Avoid setting items on other tracks editable**.
 - Whether to **Avoid setting items on non-playing lanes visible**.
 - **Double-click behavior:** Whether double-clicking a note should switch the active media item and, if so, whether this should occur only when the media item is on the same track and/or already editable.
 - Whether **double-clicking outside the bounds of a media item should extend that media item**.
 - Option to display a panel showing more information about multiple media items in a single MIDI editor.
 - Set **Opacity for notes/CC in inactive media items**. The higher the number, the darker the notes.
 - **Default note color map:** allows you to specify your own default note color map.

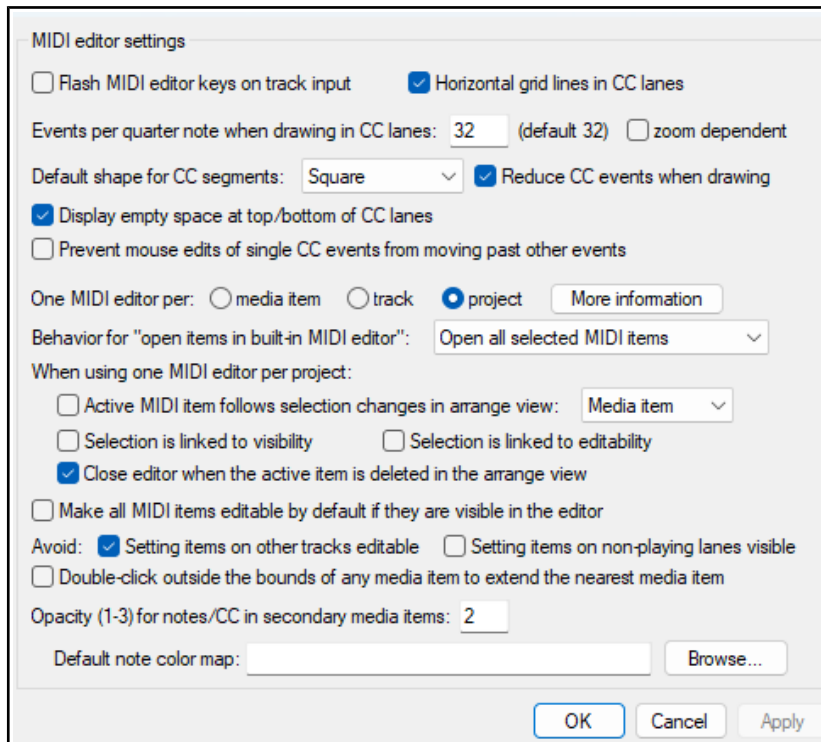

REAPER's Preferences and Other Settings

22.9 Media Preferences

Options to **Set media items off line when application is not active** and to **Allow videos to go offline**. Toggle option to **Prompt to confirm filename on "open copy in editor"**.

Set tail length when FX applied to items and takes.

Duplicate take FX when splitting:

Determines whether any existing FX in an item's FX chain are automatically copied to new items that are created when the original item is split.

22.9.1 Media, MIDI Preferences

MIDI octave name display offset: by default, middle C (MIDI note 60) is labelled C4. E.g. an offset of, say, -1 would cause this to become C3.

Allow trim of MIDI items when splitting will add a note-off message for any note that spans the split point when a MIDI item is split. Toggle option to **chase CC/PC** when splitting.

Pool MIDI source data is explained in Chapter 13. You can disable this.

Items created or imported as REAPER **MIDI items** (rather than .MID files) can be better edited in the MIDI Editor. **.MID files** are more portable between apps. You can create MIDI items and later export to file.

Ticks per quarter note sets data resolution for new MIDI items. The default setting of 960 equates to 2 ticks per microsecond at 120 bpm.

You can specify when **Importing multichannel MIDI files** whether to create a series of single channel tracks, one multichannel track, or always to prompt, and whether to **Always prompt to import tempo from MIDI files with simple tempo maps**.

Snap behavior can be set so that time signature changes in imported MIDI files are set to whole bars, and that tempo changes in imported MIDI files are set to whole beats.

Export **MIDI text events** in Latin-1, UTF-8 or ASCII (7 bit) format.

22.9.2 Peaks Generation

Generate peak caches: You can set peak caches to be generated **on import**, and/or **on project load**.

Whether to **Automatically rebuild** when loudness/spectral/spectrogram enabled.

Not to generate enhanced peaks when in plain peaks view/ unless in spectral peaks view/ unless spectrogram enabled.

Whether to **Show status window while building peaks**.

Prioritize peak building order for multiple files: longest media first, project order, track order or filename order.

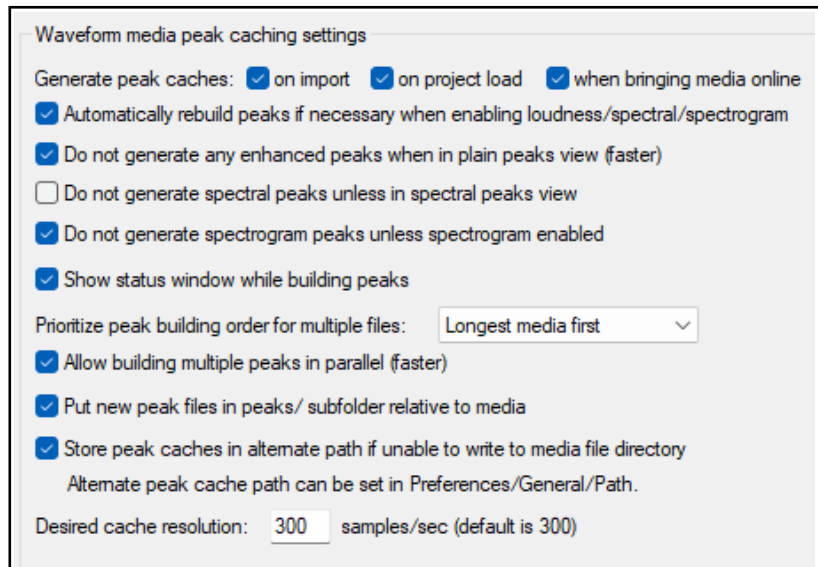
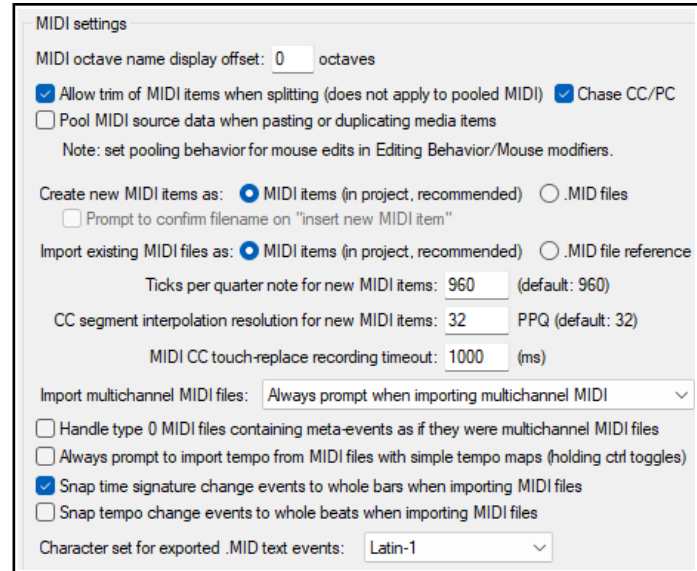
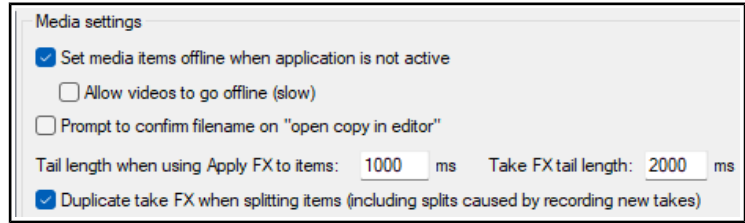

Whether to **Allow building multiple peaks in parallel**.

Whether to **Put new peak files in peaks/subfolders relative to media** and **Store peak caches in alternate path if unable to write to media file directory**.

Option to specify **Desired cache resolution**.

22.9.3 Video Preferences

For **Video preferences** see Chapter 20.

22.9.4 Media, Import Preferences

When inserting multiple media items: Choose whether the **default behavior** should be to **insert as separate tracks**, to **insert sequentially in a single track**, for **REAPER to determine which appears the more appropriate**, or whether you wish to be **prompted each time**.

Copy imported media items to project media directory: helps you to keep together files that belong together. Whether to use the media file name to **Automatically name unnamed tracks on media import** and whether to **Remove trailing numbers**.

Whether to **Allow drag import to insert tracks** (see chapter 4.7).

Option to to **adjust media or project bpm** if media tempo is guessed from file length

Other **Media Import** options include how you wish to deal with **embedded slice information**, in particular how to **import files** and how to handle **slice tails**.

Options for importing **media with tempo information in metadata or file name** depend on whether or not the tempo is reliable or suggested. There are options **After adjusting tempo, set imported media to auto-stretch at tempo changes** and to **Warn about potential playback when importing raw PCM audio**.

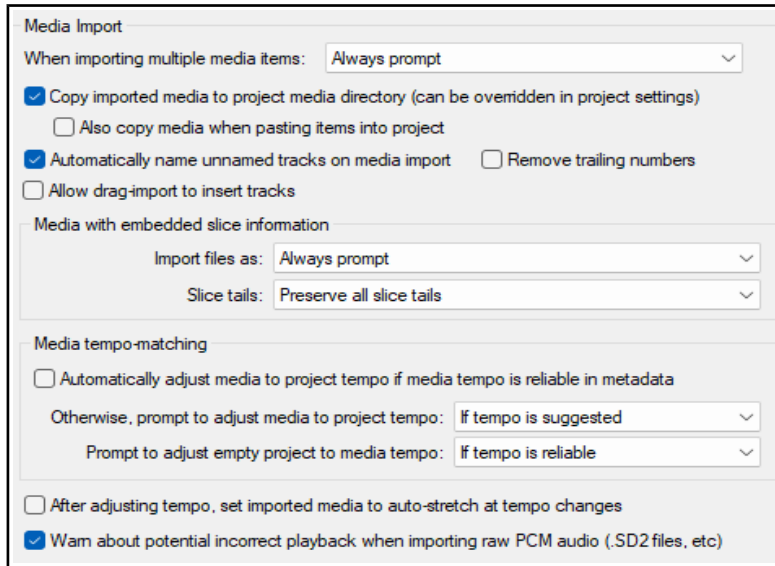

22.10 Plug-ins Preferences

Your two **Automatically resize FX windows** options, if enabled, will ensure as you browse thru a track's FX chain that the FX window is automatically resized to suit the currently selected FX.

You can specify if **floatated FX windows** should automatically be placed on top, if **newly created FX windows** should be floated, and if windows should be automatically opened for FX added from the TCP and MCP menus.

You can specify whether or not to **auto-dock newly created FX windows** and whether you want the **Add FX** window opened automatically when you open an empty FX chain for a track or media item. There is an option for **FX chain hidden until added**.

The two **Positioning** drop downs (**FX chain** positioning and **Floating FX** positioning) allow you to choose **Cascade**, **Automatic** or **Modal Default** (set in **Preferences, General, Advanced**). These can be used to ensure that floated FX and/or FX chain windows will, where possible, be positioned other than cascaded on top of each other. There is an option to **Disable FX windows when rendering**.

If you enable the option to **Only allow one FX chain window open at a time** you may also specify whether you want the open window shown to change when you change track selection (**Open FX window on track**

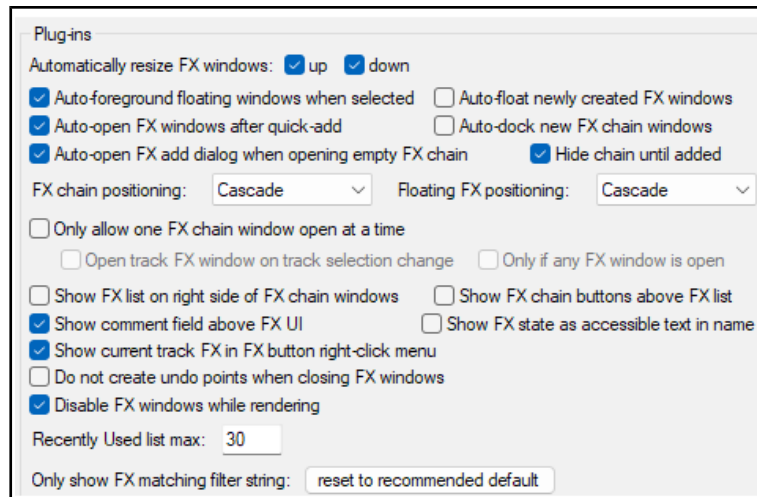

REAPER's Preferences and Other Settings

selection change) and whether this is to happen **only if an FX window is open**.

Display preferences include whether by default to **Show FX list on right side of FX chain window** and/or **Show FX chain buttons above FX list** and/or **Show comment field above the FX UI**.

Option to **Use long names prefix for parallel FX**.

You can also opt to have **track FX added to the item FX button right click menu**. This enables you to open these FX directly from this button. You can also:

- Disable **Undo points when closing FX windows**.
- Specify how many FX to show on the context menu **Recently added list** and whether **current track FX** should be shown on the FX button context menu.

You can specify an **FX filter string** to be applied to all views in the FX browser (e.g. *NOT sony* if you do not want these plug-ins to be shown). This is as well as [to any filter you apply in the FX browser itself](#).

22.10.1 Plug-ins, Compatibility

Options available include:

- ◆ to use **pre-zero output buffers** (enabled by default).
- ◆ to **reduce denormalization from plug-ins** (enabled by default).
- ◆ to specify the **automation rate when interpolating between points**.
- ◆ To **disable saving full plug-in state** (not recommended).

The global option for plugin bridging was removed in REAPER 6.33: bridging is now controlled [per-plugin via FX browser](#). Discussions on how these options can be applied in can be found on the REAPER forums.

Note the option to Terminate REAPER immediately if a plug-in causes a corrupt heap. This will cause REAPER to crash if a buggy or malicious plug-in is detected.

22.10.2 Plug-ins, VST

Chapter 1 explained how to [locate and enable VST plug-ins](#). Other preferences are:

You can set **VST plug-ins to by default be displayed using REAPER's UI** rather than that plug-ins GUI.

For handling VST parameter automation notifications you can **Ignore when window not open, Ignore when not from UI thread, Ignore all notifications, and Process all notifications**.

Other preferences depend on which plug-ins you use, because individual plug-ins vary so much in their behavior. You may need to experiment to get the best results.

Hover your mouse over any option to see a Help message at the bottom of the window.

For further help, be prepared to ask questions on the REAPER forum. Especially worth noting (for MIDI users) are:

- ◆ the options **Don't flush synthesizer plug-ins on stop/reset** and **Don't send note-offs or pitch reset messages on stop/reset**.
- ◆ to use any VST3 ARA plug-ins (Melodyne 4.2+, Revoice Pro 4+, etc.) then **ARA** must be **enabled**.

22.10.3 Plug-ins, ARA

Enable ARA for plug-ins that support it – requires restart of REAPER.

Pool ARA edits for all copies of same source media by default.

See Melodyne documentation for more information about editing.

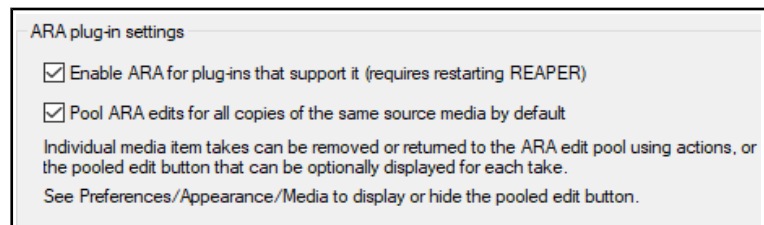
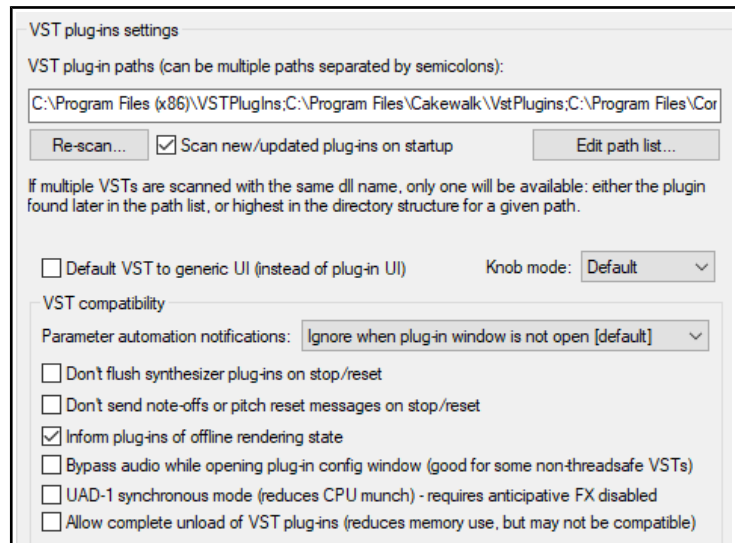

22.10.4 Plug-ins, LV2/CLAP

Options are available to determine LV2 plugin paths, to re-scan for LV2 plug-ins, and to determine how REAPER is to handle LV2 plug-in names (shown right).

For CLAP plug-ins you are able to determine the path list and to re-scan.

22.10.5 Plug-ins, ReaScript

The use of ReaScript is beyond the scope of this User Guide, but you can find an overview in [Section 23.9](#).

22.10.6 Plug-ins, ReWire/DX

ReWire options include whether to:

- ◆ Allow Rewire mixer support.
- ◆ Auto-open panels when opening ReWire devices.
- ◆ Run FX on stop when ReWire devices are active.
- ◆ Check for ReWire mixer device on startup and automatically enter client mode if present.
- ◆ Use alternate configuration file (reaper-rewire.ini) when in client mode.
- ◆ Specify ReWire client project settings.

Direct-X (DX) options are:

- ◆ Enable DX plug-ins.
- ◆ Scan DX plug-ins on startup (not required).
- ◆ Disable DX plug-in scanning.
- ◆ Scan/Rescan all DX plug-ins.

22.11 Project and File Management

You have already seen that when you save a REAPER project file you have the option to create a subdirectory for that project, and to copy, move and store all of the project's media files into that directory. Making use of this option will make it easier for you to keep track of your work.

However, you will most likely find that as a project evolves, it will accumulate any number of media items, such as rejected tracks and overdubs, or deleted items that are no longer required. You can easily remove these unwanted items, using the command **File, Clean current project directory**.

The name of the current project folder is shown below the title bar. You can click on the Explore button to explore the folder's entire contents. Notice, however, that all the files present in

the project directory but not belonging to the current project are listed in the Project Directory Cleanup window.

To select a file, click on its name. To build a selection, hold the **Ctrl** key and click on each required file name. To select all files in the list, click on the first file name then, holding the **Shift** key, click on the last required name.

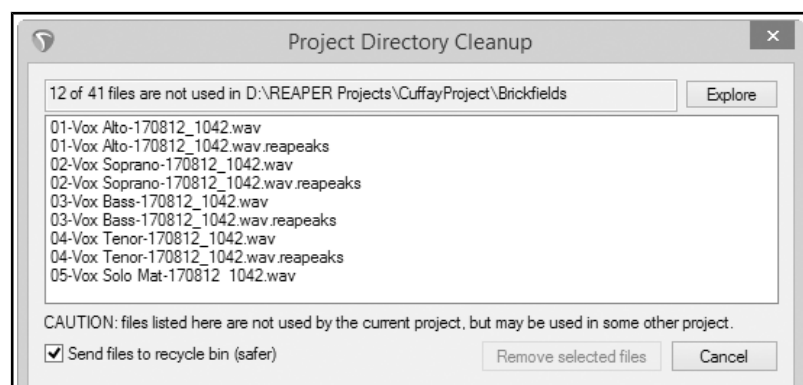
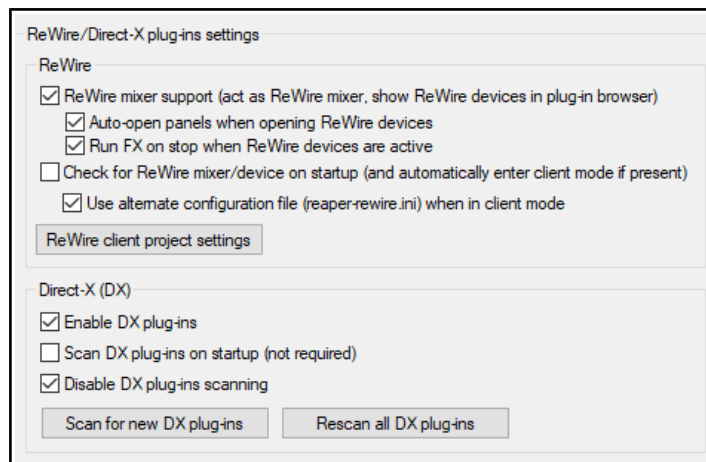
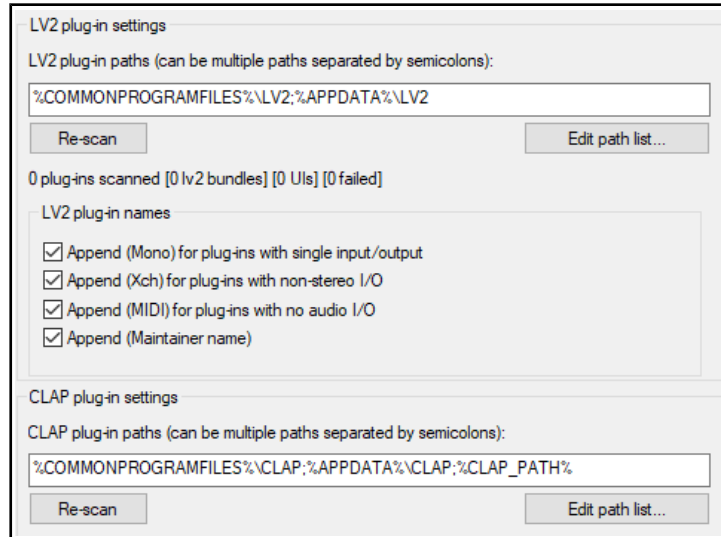

REAPER's Preferences and Other Settings

You have the option to either delete these files permanently from your hard drive, or to send them to the Windows Recycle Bin (as shown here). Click on the **Remove Selected Files** button to remove them.

Don't forget also to **backup** your work regularly, to a flash drive, external hard disk, CD or DVD, or more than one of these. The easiest way to back projects up is to simply use the Windows file management system.

22.12 Customizing the Performance Meter

You can customize performance meter display, making your selections from its context menu (see right).

Amongst the items that can be displayed or hidden are:

CPU Graph	CPU Use	Disk Use
RAM Use	Free System RAM	FX CPU use

There are also options to display CPU utilization with all cores or one core fully utilized, or longest block is realtime (worst case scenario). The last of these can help diagnose problematic real-time plug-ins.

To sort the Performance Meter track list, click on any column heading. It can also be docked or undocked.

Note: The RT ("Real Time") CPU meter measures the amount of CPU time used by the single audio thread servicing the sound device. It reflects only the CPU time used by one core, and gives you an indication of how much leeway you have in processing. With anticipative FX enabled (and few tracks record armed), RT CPU should be pretty low, as most things should be done asynchronously, allowing the real time thread to quickly put things together.

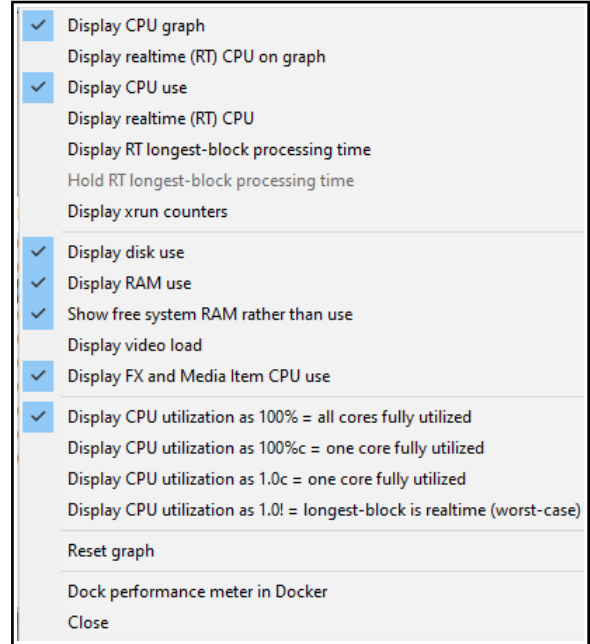

22.13 Customizing Undo History Behavior

As already discussed (Chapter 2), in **General preferences** you can customize your Undo History, including:

- Add undo points for item/track/envelope selection and/or cursor movements.
- Save Undo History with project files.
- Allow load of Undo History.
- Store multiple redo paths.

These features can be selected from the **Undo Settings** section of the **Options, Preferences, General, Undo** screen.

Enabling the option to **Store multiple redo paths where possible** means that whenever you go back to an earlier point any actions you take from that point on will be stored as an alternate set: REAPER will remember both paths independently of each other. Moreover, every time you return to that point, another new undo path will be created.

An example is shown above. The highlighted action **Add Region** is flagged with **(*2)**. This means that as well as the original set of actions, two more undo history paths exist where twice we have gone back to that point. By right-clicking where shown, we are able to choose which undo state we wish to load, thus enabling us to restore those commands and actions. There are also options to **Remove selected undo states from undo history**.

If you enable the options to **Save undo history with project files** and **Allow load of undo history**, then the undo history will still be available to you next time you use this project file, even if you have since closed and restarted REAPER.

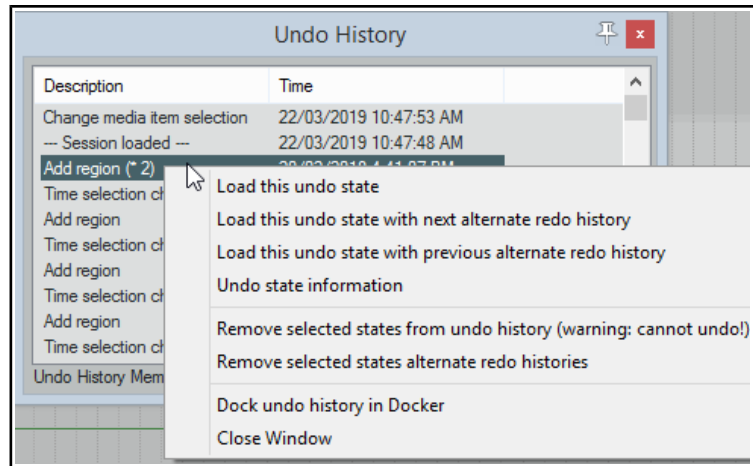

22.14 Custom UI Tweaks (PC)

The **General** page of the **Options, Preferences** window includes an **Advanced UI/System tweaks** button which enables you to further customize REAPER's on-screen appearance.

There are some differences between PC (Windows) options and Mac (OS) options. Shown right are the options for PC users:

Custom Splash Screen – A .BMP or .PNG file.

Use large window frames for windows.

Scale UI Elements (e.g. buttons on toolbars). Can be useful if using high screen resolution. This can be used to display some screen elements as larger (if set above 1.0) or smaller (if set below 1.0)

Allow track envelope/routing windows to stay open. Select this option if you want track routing and envelope windows not to be closed automatically when they use focus.

Advanced system and multiprocessing tweaks to determine how REAPER behaves on a system with two or more processors. Use caution!

How you would like **modal windows to be positioned** on reopening: **Last window position**, **Center on current screen**, **Center on mouse cursor** or **OS positioning**.

HiDPI mode (Windows 8.1+): Unaware, Aware, Multi-monitor aware or DPI ignorant.

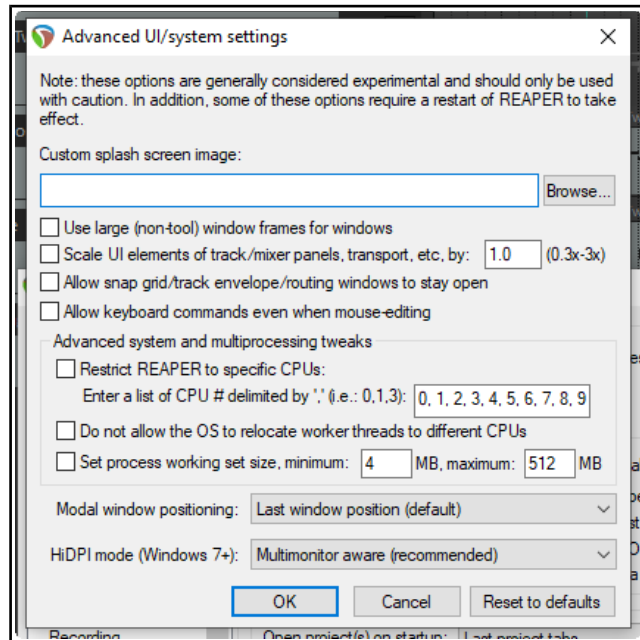

22.15 Custom UI Tweaks (Mac)

The main different Mac options are:

Auto-hide dock when in fullscreen mode – toggle on/off.

Toggle on/off the use of **Rounded mac/OS buttons** and/or **Use of larger listview margins on Big Sur**.

Setting **Main window fullscreen button to activate REAPER-native fullscreen**.

Allow retina drawing of user interface and For non hidpi themed elements: this displays sharper text.

Allow 10.14+ dark mode. May cause display issues with some plug-ins.

Modal window positioning: options are
Last window position (default)
Center on current screen
Center on mouse cursor
OS positioning

Display updates: options are -
Automatic (recommended, Metal on 10.11+)

Disable all optimized drawing (reduces GPU use)

Force classic (10.5-10.9) drawing mode

Whether to enable (individually) the throttle mouse events **Wheel**, **Swipe**, and/or **Move**.

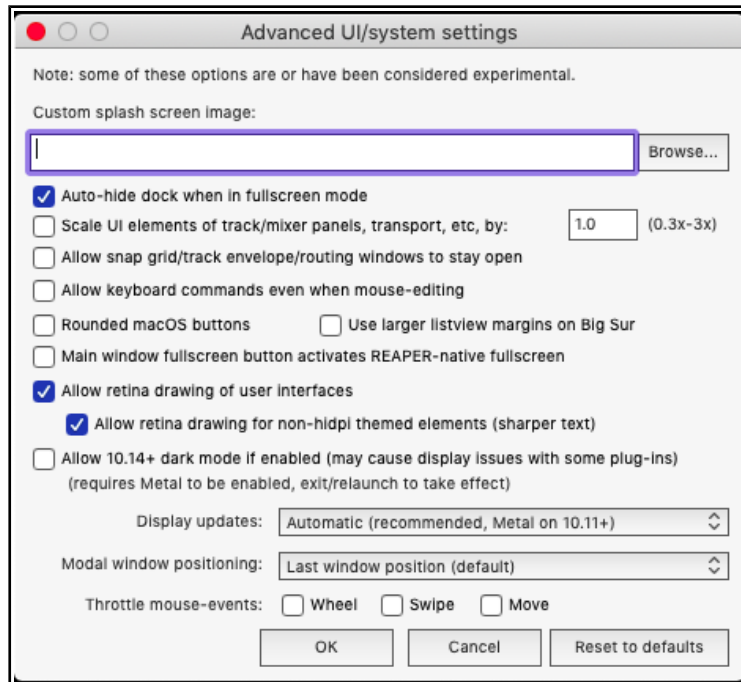

Using REAPER with Other Applications and Devices

23 Using REAPER with Other Applications and Devices

23.1 Introducing ReaRoute (PC Only)

ReaRoute is an ASIO driver that allows you to route audio to and from any other ASIO enabled application. ReaRoute is only installed on your system if you select the **ReaRoute ASIO driver** during the REAPER installation process. This option is found on the REAPER Setup **Choose Components** screen, under the heading **Optional Functionality**. If you did not have this option selected (or if in doubt) when you last installed REAPER, simply reinstall REAPER, this time making sure that it is selected.

When you install ReaRoute, the **ReaRoute ASIO driver** appears in the ASIO driver list for the other audio applications on your system.

Note: Some users have reported problems with native ASIO drivers after installing the ReaRoute driver. If you experience problems with your ASIO drivers after installing this feature, uninstall REAPER, then re-install with this check box cleared.

Once ReaRoute has been installed, you can pass audio streams between REAPER and other audio applications. This could, for example, be another DAW such as Cubase or Ableton Live, or a stand-alone synth such as Cakewalk's Project 5. In overview, the basic steps are:

- Set up the other application to work with ReaRoute.
- *Either* Send audio from REAPER to another DAW and record it track by track within that application.
- *Or* Send audio from the other DAW to REAPER, this time bringing it in as a series of submixes. You can then apply REAPER features to that project.
- *Or* Use a stand alone synthesizer workstation such as Project 5 in conjunction with REAPER.

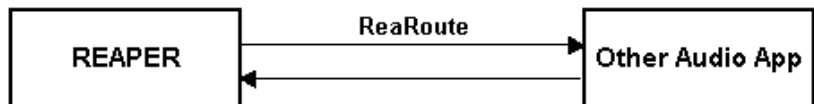

23.2 Setting Up Applications for ReaRoute

Before you can use any audio application with REAPER via ReaRoute, you need to ensure that the audio settings for that application are set up correctly. There are usually one or two basic steps involved.

The first is to enable **ReaRoute ASIO** as the preferred driver, the second is to enable the various input and output channels required to transmit audio between the application and REAPER. With some applications, this second step is not required. The method will vary with the application, but always involve specifying your preferences on the **Audio Settings** dialog box (or similar).

The table below gives some examples. They are accurate at the time this is being written, but be aware that all software programs are likely to change over time. Note that before setting up or using any application for use with ReaRoute, you should 1) make sure that the ReaRoute ASIO Driver has been installed (see previous page), and 2) make sure that REAPER is open and minimised.

Application	Instructions
Ableton Live	<ol style="list-style-type: none">1. Options, Preferences then click on the Audio tab.2. Set Driver Type to ASIO.3. Set Audio Device to ReaRoute ASIO.4. Click on Input Config then on each input channel to be enabled, then OK.5. Click on Output Config then on each output channel to be enabled, then OK.6. Close Preferences window.
FL Studio	Options, Audio Settings , then select ReaRoute ASIO for Output . Close Audio Settings window.

Note for macOS users:

Although the macOS does not support ReaRoute, there is third party software available, such as Soundflower and Loopback (by Rogue Amoeba), which can perform similar functions.

23.3 Sending Audio from REAPER to Another Application

This example looks at sending a project from REAPER to another DAW. You might wish to do this, for example, to use one of that DAW's native plug-ins on a track or series of tracks. Provided you know your other application well enough and have already set it up to use ReaRoute (see previous page) you should be able to apply these guidelines. They are:

1. Open REAPER. *It is important that you open REAPER before the other application.*
2. Open the project file that you wish to use. For each track that you wish to use, create a hardware output to a different ReaRoute channel.
3. Open the other application (e.g. Sonar, Cubase, Ableton Live) and create a new project file.
4. Insert into your new file one new track for each track that you wish to bring in from REAPER. For each track, the input should be set to correspond with the equivalent output used in REAPER. For example, if in REAPER you set a track's output to *ReaRoute Channel 1*, then the corresponding new track in your other DAW will need to have its input set to *Left ReaRoute ASIO ReaRoute REAPER Channel 1*.
5. Within the second application, start recording. Within REAPER, play the song.
6. Stop both when the song finishes.
7. You can then do whatever work you wish.
8. When finished, first close the other application and then close REAPER. You should always remember – *Open REAPER first, close it last.*

In many cases it would be easier and quicker simply to import the wave files directly into the other application. There are, however, other instances when it may be advantageous to use ReaRoute instead. For example:

- It might not be easily possible to line up all tracks. Some may start and finish at different times. Others might consist of a large number of media items each of short duration. It would be difficult to import these piecemeal.
- Some tracks might consist of a combination of MIDI items and audio items. Many applications do not let you mix MIDI and audio on the same track. This way, they are all taken across as audio.

23.4 Sending Audio From Another DAW App to REAPER

Staying with the same example, we are now going to use ReaRoute to take our open Sonar project and send an audio signal back to REAPER. In overview, this is how it is done.

1. Open REAPER and create a new project file. Insert as many tracks as you need.
2. Assign ReaRoute inputs to these tracks as required (see right). Arm these tracks for recording.
3. Open the other DAW. In that DAW, open the file you wish to work on, and assign outputs on a track by track basis to your various ReaRoute channels as required.
4. Still in the other DAW, insert any FX that you may wish to use in these tracks. Play the song in the other DAW, adjusting your FX to suit.
5. When ready, start recording in REAPER, then play the song in the other DAW, from the beginning.
6. When finished, stop both playback and recording.

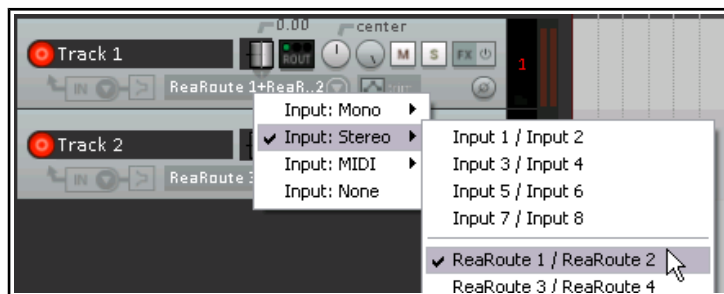

23.5 Using REAPER With a Synth Workstation

ReaRoute can be used to make the functionality of a stand-alone synthesizer available to you when you are working with REAPER. To be able to work thru this example, you will need to already possess a good working knowledge of how to use the synthesizer.

Using REAPER with Other Applications and Devices

Before proceeding, you will need to ensure that your ReaRoute ASIO drivers have been installed and that the Synth Workstation program has been set up to use them.

1. Open REAPER. Open an existing project file, or create a new one and insert a track.
2. Arm this track for recording. Turn on input monitoring and set the track input to stereo. Assign a pair of ReaRoute channels (probably 1 and 2) to this input.
3. Open the synth program and take whatever steps are needed by way of preparation.
4. Direct audio output to the same pair of ReaRoute channels that you selected at step 2. (above).
5. In REAPER, make sure the play cursor is positioned where you want it. Press **Record**.
6. Within the synth program, play the instrument(s) to compose a track to accompany your REAPER song. As you do so, REAPER will record it as a wave file.
7. When finished, save your work.

23.6 Syncing to an External Device

If you are using REAPER in conjunction with an external device then you may need to ensure that your DAW is in sync with that device, and to take its time clock from that device. For example, you may need to make REAPER the client of another DAW, or to a video deck. Another example might be if you need to upload time-stamped material from ADAT tape. To synchronize REAPER to an external timecode, follow this sequence:

- Right click over the **Play** button on the Transport Bar. This opens the settings dialog box shown here.
- Select the Input to be used. Available sync types include ASIO Positioning Protocol, MTC and SPP.
- Complete the other settings and close the dialog box. You should consult the documentation of your external device for further information.
- To play REAPER in sync with an incoming timecode, hold **Alt** while **right clicking** on the play button to toggle this client to timecode on and off.

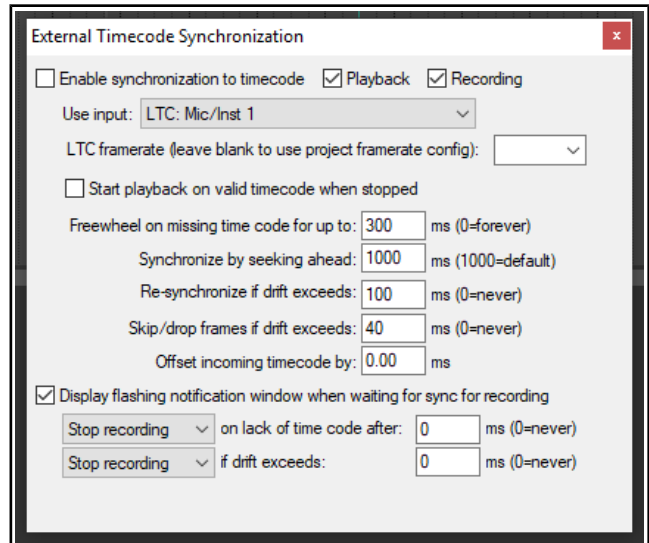

Sending Clock/SPP from REAPER to an external MIDI Device

To send Clock/SPP data from REAPER to an external MIDI device, you need first to have enabled the feature under **Options, Preferences, MIDI Devices**. Then ...

Double-click on the MIDI output device name to open the **Configure MIDI Output** dialog box, and select the option **Send clock to this device**. There is an option to exclude song position pointer data (**SPP**) from the MIDI clock signals. There is also an option to **Open device in low latency/low precision mode**.

23.7 Generating and Sending Timecode

The command **Insert, SMPTE LTC/MTC Timecode Generator** (from the main menu) can be used to send a synchronization timecode from REAPER to an external device. This command inserts on to the current track a media item which is used to generate the timecode.

Right-click over the item and choose **Source properties** from the context menu to display the settings box (right).

Select LTC (linear/longitudinal time code) or MTC (MIDI time code) and configure the various parameters as required.

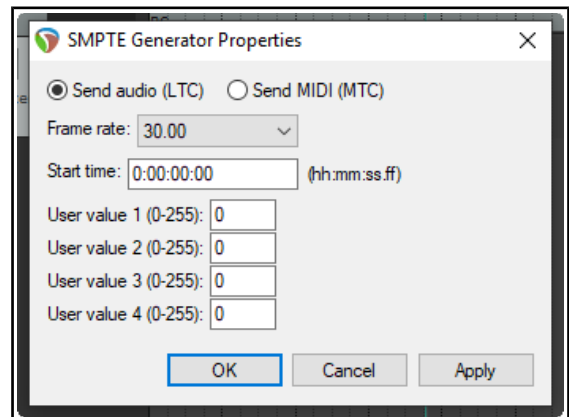

23.8 REAPER as Client to MIDI Sequencer Software

REAPER can also be the client of a software MIDI sequencer (such as Temper). You will need virtual MIDI cable software, such as the highly popular MIDI Yoke. Here is an overview:

1. Use MIDI Yoke to install a virtual MIDI cable to send MIDI out from your other program and in to REAPER.
2. Start REAPER. Go to Preferences, Audio, MIDI Devices. Right click over the MIDI device labelled *In from MIDI Yoke: 1* (or similar) and choose **Enable input for control messages**. OK preferences.
3. Right-click REAPER's Play button, enable the **Enable synchronization to timecode box** option (see right) and enable playback, recording, or both. Select the required MIDI input port (in this example *MTC: In from MIDI Yoke 1*). When you close this dialog box, the play button will display a small padlock and the tooltip *client to timecode*. Engaging this play button will now mean it is ready and waiting for sync input.

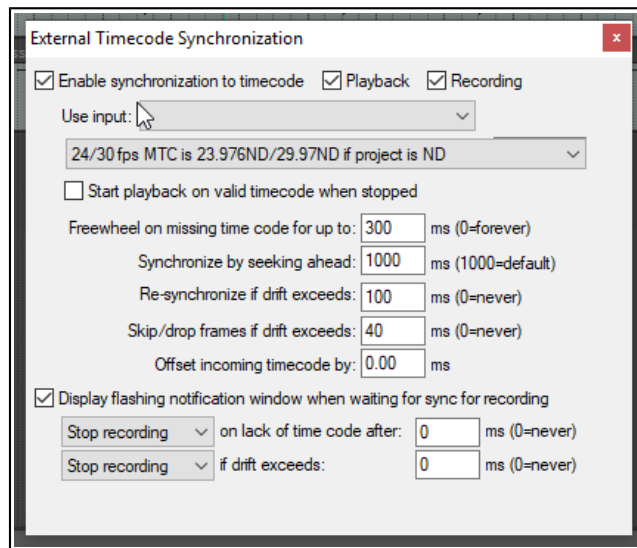

4. In the external program, add a MIDI track and direct its output to the same MIDI Yoke cable as you used for input in REAPER. You may also need to enable *Send MTC* (Midi Time Code) in this program. How you do this in any specific program will of course depend on its own features, interface and capabilities. You will now be ready to go.

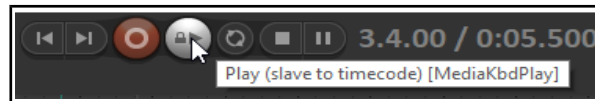

For assistance with how to do this with any specific software, consult or ask on one of the REAPER forums.

23.9 ReaScript

ReaScript is a scripting language that takes your ability to customize REAPER well beyond that offered by the Actions List editor. With ReaScript, you can not only create more powerful and sophisticated macros, you can even create your own extension commands. To use ReaScript, you will need to have a good knowledge of a scripting language such as EEL, Lua or Python. EEL and Lua are embedded in REAPER. You can download Python from the **Options, Preferences, Plug-ins, ReaScript** window.

ReaScript isn't for everyone – in fact, because it requires an understanding of programming it isn't for most people. You can find out more by choosing **ReaScript documentation** from REAPER's **Help** menu, and by clicking on the option **View ReaScript Help** on the Plug-ins, ReaScript page of REAPER's Preferences window.

For more about ReaScript see also <http://www.cockos.com/reaper/sdk/reascript/reascript.php>

To be able to use Python, enable it under **Options, Preferences, Plug-ins, ReaScript** (above). On the **External Editors** preferences page you can also specify an external editor for writing and editing scripts.

Using REAPER with Other Applications and Devices

23.10 NINJAM

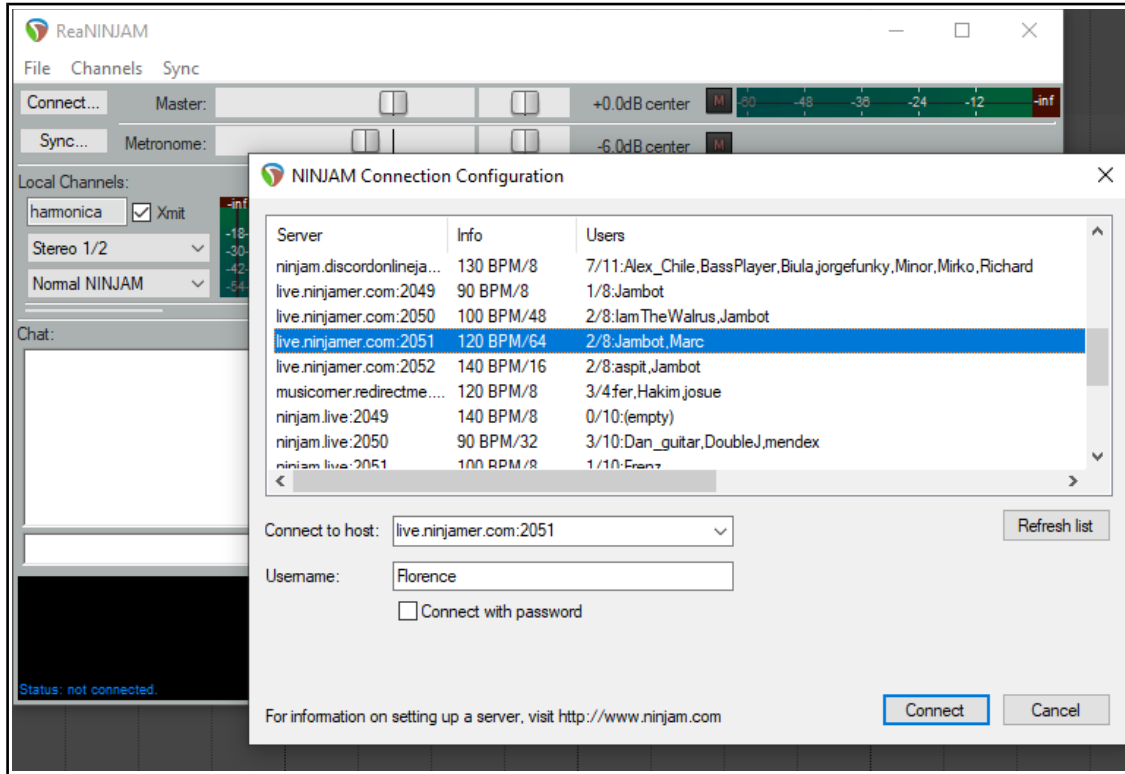

NINJAM is open source (GPL) software that allows people to make real music together live via the Internet, each using the **ReaNINJAM** plug-in. Every participant can hear every other participant. Each user can also tweak a personal mix to their liking. NINJAM is cross-platform, with clients available for Mac OS X, Linux, and Windows. More detailed information about NINJAM can be found at <https://www.cockos.com/ninjam/>

The Server

You can create your own server for your band/group members/friends to use exclusively or you can log in to one of the available public servers and join in there. Information on setting up a server is available at:

<https://www.cockos.com/ninjam/server-guide.php>

A current list of public servers is shown here:

<http://autosong.ninjam.com/server-list.php>

To connect to NINJAM via a public server (with basic options):

1. Create a new project, add a single track and insert **ReaNINJAM** into its FX chain. If necessary, click on the **Show ReaNINJAM Console** button to open the plug-in's interface.
2. If no local channel is shown, click on **Add Local Channel** and give it a name (for example, if you will be playing a harmonica, call it harmonica). If an existing local channel is shown you can use that.
3. You will now need to join a server. From the ReaNINJAM menu bar, choose the **File, Connect** command (or click on the **Connect** button) to display a list of public servers. Look in the **Users** column for one that has available slots. For example, a server showing 8/8 users will have no available slots. Where 2/8 is shown (as in the above illustration) there will be six available slots.
4. Select your preferred server, type in a **Username**, clear the **Connect with password** option, then click on **Connect**. Agree to the terms.
5. When are connected, click on the **Sync** button and choose **Start REAPER playback on next loop**.
6. A list of other current users will be displayed within the **ReaNINJAM** window. You can adjust the volume and panning of each of their instruments. These adjustments will affect only what you hear.

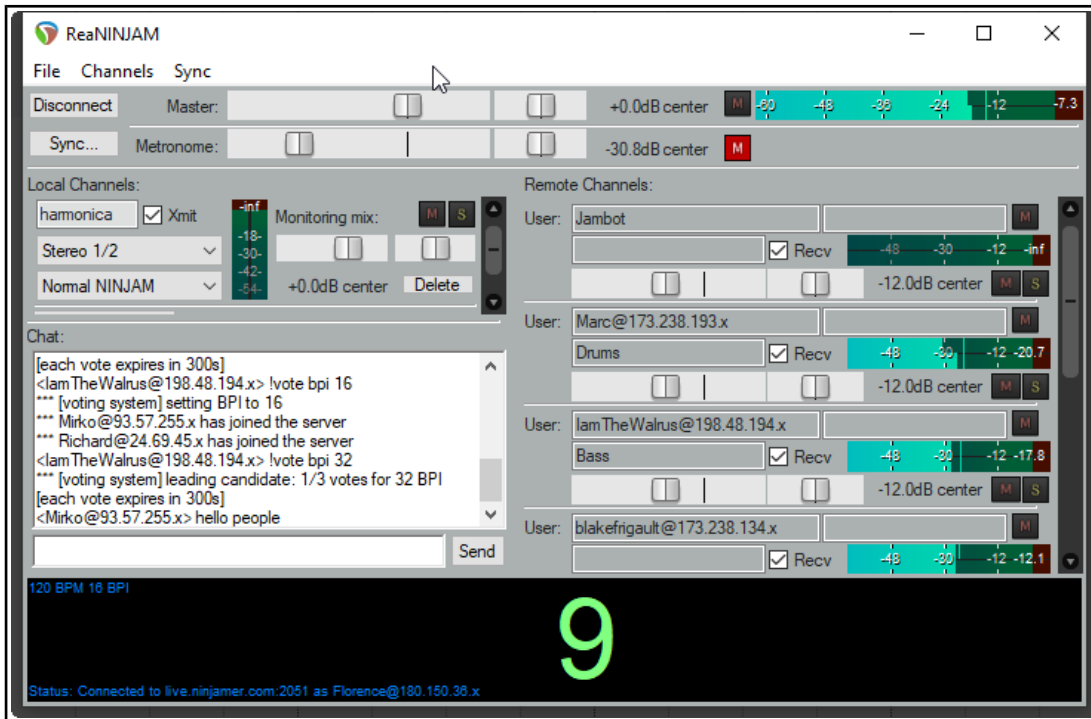

7. The panel at the bottom traces and displays visually the beat of the metronome. There is a fader near the top of this window which can be used to adjust metronome volume.
8. The faders in the right hand panel (above the metronome display panel) can be used to adjust the volume and pan position in your headphone and/or speaker mix of each other participant.
9. For the moment, set the plug-in to bypass. Create a new track within the project. Give it a name (e.g. Harmonica) and arm it as for recording. Set the input source etc. in the usual way. For example, this could be a MIDI input (actual or virtual keyboard), or and audio input via a lead or microphone. If using a microphone, output should be directed to headphones only to prevent feedback.
10. Select your NINJAM track and make it into a folder. Make track 2 the last track in the folder.
11. Select the NINJAM track and disable bypass on ReaNINJAM.
12. You're good to go now!

Latency in NINJAM is calculated in measures, rather than microseconds, so there is no perceived latency when jamming, but it doesn't really lend itself to real-time band practice. See cockos.com/ninjam for more information about how latency works in NINJAM.

Various further options are available. In overview, these include:

- Many keyboard shortcuts are available for use within NINJAM. For example, F1 to F10 can be used to select individual channels, and various key combinations can be used to manage channels. These are shown on the Channels menu.
- An option to save multitrack recordings for mixing later (File, Preferences menu).
- Options to run NINJAM in normal mode, voice chat mode (less latency) or session mode.
- Options to mute the master or the metronome (Channels menu).
- Options to mute or solo individual channels (Channels menu).
- Options to select a specific remote user or channel (Channels menu).

For more information about these and other aspects of NINJAM, drop by the Ninjam users forum at: <https://forum.cockos.com/forumdisplay.php?f=8>

Appendix: Troubleshooting REAPER

Appendix: Troubleshooting REAPER

This section aims to help you resolve problems that are sometimes encountered by new users. Many of these issues relate to Windows, though some will also be relevant for macOS users. These tables are not the panacea that will solve all your problems, but it is a good place to start.

Input/Output Issues

Input Output Issues	
Problem	Diagnosis and Possible Solution
When I try to record audio, nothing is recorded	<p>The problem could be with your REAPER settings or with your hardware set up.</p> <ul style="list-style-type: none">Make sure the track is armed for recording.Make sure that the track has been assigned an input.Check (Options, Preferences, Audio Device) that your range of audio inputs has been defined <i>and enabled</i>.Make sure under the Options menu that you have the correct required Record Mode set (usually this should be Normal).Check that <i>Record Input</i> is enabled. Or, if you have selected <i>Record Output</i>, check the FX window for any FX that could be silencing the track's output.Make sure (Record Arm context menu) that <i>Record disable</i> is not enabled.Check in <i>Project Settings</i> that you have not specified a non-existent or unauthorized path, or limited project length to zero..Make sure that the microphone or lead for the instrument being recorded is connected to the correct audio input.If the microphone requires phantom power, make sure that the phantom power supply is enabled.Check your audio input mixer (external hardware desk, sound card mixer software, or both) to make sure that the incoming signal is correctly routed.Check your audio input mixer (external hardware desk, sound card mixer software, or both) to make sure that the incoming signal is not muted.
When I play back, my audio track is silent, even though there is activity in the track's VU meter.	<p>The problem is likely to be either with your routing in REAPER, your sound card's settings or with your audio hardware setup.</p> <p>REAPER's Routing:</p> <ul style="list-style-type: none">Make sure that the track's output is directed to the master.Make sure that the Master output is directed to the correct outputs on your sound card for your speakers or headphones. <p>Sound Card Settings:</p> <p>Use the control software supplied with your soundcard to make sure that neither of the following has occurred:</p> <ul style="list-style-type: none">Output muted, or volume lowered too much.Output patched to different hardware output. <p>Audio Hardware Setup:</p> <ul style="list-style-type: none">Make sure that the amplifier is connected to the same outputs on the soundcard as the output of the Master.Make sure that everything is connected to the power supply, switched on, and with appropriate volume levels.Use Windows Device Manager (Control Panel, System, Device Manager, Sound video and game controllers) to ensure the device is enabled and functioning correctly. <p>Tips:</p> <p>Opening a different application and playing any audio file can help determine whether the problem lies within REAPER or with your Sound Card or Audio Setup.</p>

Up and Running: A REAPER User Guide v 7.31

Input Output Issues	
I get an error message to the effect that MIDI device(s) cannot be opened.	The device may not be connected, or may be in use by another program. Check that the device is connected and supplied with power. Check whether another program has use of the MIDI device. Check that you have not accidentally opened REAPER twice.
When I play back, my audio track is silent, and there is no activity in the track's VU meter.	The problem is likely to be specifically related to that track or item, especially if you have other projects which do play correctly. Make sure that the track has not been muted. Make sure that the item has not been muted (right click over item, Item Properties). Check the FX Window for the track to make sure there is no FX which is causing the track to be silenced. Check the track's volume fader to make sure it is not too low.
When I play back, I don't hear some or all of a track's FX being applied.	The problem could be happening in the track's FX window or in the plug-in's own window, or both. Check that the track's FX Window is not in bypass mode. Check that the individual FX has not been set to bypass mode. This might occur in the FX Chain window or with some plug-ins within the plug-in's own window. Check that the plug-in's Wet/Dry mix setting (where present) has not been set to 100% dry.
When I play back, panning does not work, everything comes from the center	Check Preferences, Audio, Device settings, especially first and last output. Check Master output is not set to mono, and that master outputs are correct (usually this should be channels 1/2). Check track is routed to the Master via correct parent channels - usually 1/2 .
When I play back, I get clicks, pops, stutters or dropouts	This probably means that you are attempting to play this project at a latency too low for your system. This is more likely to happen if you use a large number of CPU hungry FX such as Reverb. Try one or more of these remedies: Consider rearranging your mix to use fewer CPU intensive plug-ins, e.g. by making more use of FX busses to share FX used by more than one track. If you are using a high sample rate, such as 88200 or 176400, try a lower one. Go to File, Project Settings and reduce the Sample rate to 44100. This will reduce the load on the CPU and you will probably find that you can live with any perceived difference in sound quality. Consider increasing buffer size. This increases latency, but should not be a problem when playing back. Go to Options, Preferences, Audio Device . Click on <i>ASIO Configuration</i> to bring up the Control Software for your sound card. Increase buffer size, perhaps to 1280 samples. Check your Audio Buffering preferences, especially for FX processing/multiprocessing . Be prepared to experiment with <i>Render ahead size</i> and with which options are allowed.
On play back, the Master clips and distorts, even though the track level(s) appear low	This can arise as a result of routing problems, for example when you have any track or tracks routed to the Master by several different routes at the same time. Check the Routing Matrix.
When I play back, the audio sounds clipped, even though it doesn't appear to be visibly clipping anywhere	There could be a routing problem, or some FX might be distorting your sound. Check the Routing Matrix to see if any track(s) is/are being directly routed to the same audio hardware output as the Master. If not ... Disable all FX to see if this fixes the problem. If it does, reintroduce the FX gradually until you can identify which is causing the problem.

Appendix: Troubleshooting REAPER

Input Output Issues	
When I try to play an imported MIDI track, it is silent	This can be a routing, sound card or setup issue – see previous page. In addition it may be caused by a MIDI specific issue. This occurs when the track has not been assigned to a valid MIDI Output device or software synthesizer. If using a MIDI Hardware device, display the track's Routing Window and check it is assigned to a MIDI Hardware Device. If not using a MIDI Hardware device, display the track's FX Window, and insert a software synthesizer or instrument (usually VSTi or DXi).
I don't have enough CPU to play back my project	This could be because you are trying to use more FX than your DAW can handle. Use the Performance Meter to determine which tracks are using the most CPU hungry FX. Then right click over the media items for those tracks and either Apply FX to items as new take or Apply FX to items as new take (Mono) .
When I stop playback, the instrument/ synth continues to play	Check Options, Preferences, Audio, Playback. Disable <i>Run FX when stopped</i> and enable <i>Flush FX on stop</i> . Enter a value (e.g. 200) in the <i>Run Fx for</i> box to determine length of tail.
When I quit REAPER I am unable to hear any sound on other apps	Check Options, Preferences, Audio and enable <i>Close audio device when stopped and application is inactive</i> .

REAPER Interface Issues

Interface Issues	
Problem	Diagnosis and Possible Solution
When I open REAPER not all of the track controls are visible	This can either be as intended with the default track layout, or (Windows users) you might need to enable HDPI mode. From the Main Menu, choose Options, Layouts, Track Control Panel, B. If that does not solve the problem: Choose Options, Preferences, General. Click on Advanced UI/system tweaks. You will need to find the optimal HDPI mode setting for your system. This is likely to be (but might not be) Multimonitor aware.
When I press Space (or some other Transport Control), nothing happens	This happens when focus is with another window, such as the Routing Matrix, or an open Dialog Box. Two possible solutions are: Give focus to another view such as the Track View or Mixer before pressing the key, or Use an external MIDI control device such as a BCR2000 and assign transport functions to its various buttons. These will then work regardless of which window has focus, or whether a dialog box is open.
When I try to place the edit cursor exactly where I want it, it moves a little	Snapping may be enabled. If so, use the Options, Enable Snapping command to disable it.
When I try to make a time selection, the start and end points move from where I want them.	Snapping may be enabled. If so, use the Options, Enable Snapping command to disable it.

Up and Running: A REAPER User Guide v 7.31

Interface Issues	
My track volume and pan controls don't work on my track's MIDI items	This is as intended – these controls work on audio items only. Add one or more instances of ReaControlMIDI to the track or item's FX chain and make the adjustments there.
My track Volume or Pan envelopes do not move on play back.	Make sure that Automation Mode is set to Read and the envelope is armed.
I record multiple takes on a track, but only the last one is visible.	To view all takes for a track, choose the Options, Show All Takes in Lanes Command (Ctrl L), <i>or</i> To view a take other than the last take, right click over the media item and choose the Take command from the context menu.
When I maximize a track, the wrong track is displayed	Check your <i>Vertical Zoom Behavior</i> settings under Options, Preferences, Editing Behavior. You probably want to set this to <i>Last Selected Track</i> .
When I zoom in horizontally, the edit cursor disappears from view and I get lost	Check your <i>Horizontal Zoom Behavior</i> settings under Options, Preferences, Editing Behavior. You probably want to set this to <i>Edit Cursor or Play Cursor</i> .
I try to view a window, such as Big Clock or Performance Meter, but I can't see it on the screen	This can be tricky, and can sometimes happen because of changes made to your Windows display settings. There are two main ways to fix this. Use Windows Notepad to edit the reaper.ini file in the folder C:\Documents and Settings\User Name\Applications Data\REAPER. This should only be attempted if you are confident that you understand what you are doing. For example, if the Big Clock has been lost, delete only that section of the reaper.ini file, save it, close it, then restart REAPER. For example, in the reaper.ini file extract shown here, the Big Clock section is shown as italicized: <pre>[flac encoder defaults] default_size=12 default=63616C66100000005000000AB <i>[bigclock] wnd_vis=1 wnd_left=967 wnd_top=600 wnd_width=426 wnd_height=137 time_mode=0 [namecache] Analog_In_1_Delta_1010__1_=In 1</i></pre> A safer option would be to simply rename this file as reaper.old or similar. This will return <i>all</i> preferences and options to their original default settings next time you run REAPER.
My Undo History window is too cluttered	Go to Options, Preferences, General and disable <i>Create Undo points for item/track selection</i> .

Troubleshooting Record Modes and Monitoring

It can be difficult at first to understand how various permutations of REAPER's record modes (available from the Options menu) and monitoring options (from a track's arm record context menu) can be used together to obtain different results. Thanks to **John Bercik** for supplying the information contained in summary form below:

For a bound hard copy of the latest version of this User Guide (printed in B&W) go to LULU.com

Appendix: Troubleshooting REAPER

Record Mode	Monitor Options	Behaviors
Normal	Monitor input ON Monitor track media when recording OFF	When stopped: monitors live material only When playing: monitors existing and live material continuously When recording: monitors live material only
	Monitor input (tape auto style) ON Monitor track media when recording OFF	Stopped: monitors live material Playing: monitors existing material only Recording: monitors existing and live material
	Monitor input ON Monitor track media when recording ON	Stopped: monitors live material Playing: monitors existing and live material continuously Recording: monitors existing and live outside punch, only live inside punch
	Monitor input (tape auto style) ON Monitor track media when recording ON	Stopped: monitors live material Playing: monitors existing material, then only live in punch Recording: monitors existing material, then only live in punch
Time Selection Auto Punch	Monitor input ON Monitor track media when recording OFF	Stopped: monitors live material Playing: monitors existing and live material continuously Recording: monitors existing and live outside punch, then only live material in punch
	Monitor input (tape auto style) ON Monitor track media when recording OFF	Stopped: monitors live material Playing: monitors existing material only Recording: monitors only existing material outside punch, then only live material in punch
	Monitor input ON Monitor track media when recording ON	Stopped: monitors live material Playing: monitors existing and live material continuously Recording: monitors existing and live outside and inside punch
	Monitor input (tape auto style) ON Monitor track media when recording ON	Stopped: monitors live material Playing: monitors only existing material Recording: monitors existing material outside punch, then existing and live inside punch
Auto Punch Selected Items	Monitor input ON Monitor track media when recording OFF	Stopped: monitors live material Playing: monitors existing and live material continuously Recording: monitors existing and live outside punch, then records and monitors live material in selected items
	Monitor input (tape auto style) ON Monitor track media when recording OFF	Stopped: monitors live material Playing: monitors existing material only Recording: monitors only existing material outside punch, then records and monitors live material in selected items
	Monitor input ON Monitor track media when recording ON	Stopped: monitors live material Playing: monitors existing and live material continuously Recording: monitors existing and live outside punch, then records and monitors live material in selected items
	Monitor input (tape auto style) ON Monitor track media when recording ON	Stopped: monitors live material Playing: monitors only existing material, then only live in punch Recording: monitors existing selected item(s), then records and monitors live material in selected items

Index

1

14-bit CC messages.....240

14-bit MSB/LSB CC data.....244

A

accidentals.....284

Action List Editor.....290

Actions.....289

Add FX.....110

Add FX Chain.....40

Add Track.....57

Adjusting Track Height.....34

Advanced Disk I/O Options.....425

aggregate device (OS X).....21

AIFF.....30

Aliasing.....21

allow feedback.....31

alternative modifiers.....147

Anticipative FX processing.....116

appearance preferences.....427

appearance settings.....427

Application Data Directory.....25

Apply track/take FX to items.....160

ARA.....194

armed actions.....309

articulation.....286

ASIO Configuration.....20, 423

ASIO drivers.....423

associated project file.....224

Attach Docker.....51

Attack.....321

audio buffering.....425

Audio CD Image.....407

audio clicks and pops.....422

Audio device.....21

Audio Device.....20, 422, 423

audio dropouts.....422

audio format, converting.....78

Audio Hardware Outputs.....46

Audio inputs.....20

Audio Output.....36

Audio outputs.....20

Audio Preferences.....22

audio random access.....194

audio seek settings.....425

audio settings.....424

Audio setup.....20

audio stream.....423

Audio System.....20

auto arming tracks.....59

auto name tracks.....93

auto punch.....63

auto punch recording.....67

auto trim/split items.....126

autocrossfade mouse modifiers.....145

Automatic record arm.....59

Automating FX Parameters on the Fly.....363

Automation.....379, 380

automation envelopes.....347

automation items.....368, 369, 371

automation lanes, hiding.....356

Automation Latch.....351

Automation Methods.....348

automation mode, set default.....421

Automation Modes.....349, 350

Automation Read.....349, 351

automation settings.....434

Automation Write.....349, 351

automation, hardware output sends...364, 368

Automation, Mute/Unmute.....350

Automation, Trim/Read.....351

Automation, writing.....348

autosave.....55

Auxiliary Input.....331

B

backup.....441

Bass.....316

batch file converter.....411

batch rendering.....409

beat correction.....179

beat detection.....179

Big Clock.....54

boolean search.....110

buffer size.....422

buffers.....422

Burn Audio CD.....414

Burn Audio CD Image.....414

burn to CD.....407

Bus.....41

Bus track.....97

Bus, creating.....41

Bypass an FX.....39

C

CC Lane.....238

CC lane management.....258

CC lane, context menu.....239

CC lane, marquee selection.....239

CC lanes, resizing.....240

CC names.....240, 269

CD Audio.....407

CD burning.....407

CD Image.....407

Change rhythm pattern.....280

Change tempo.....280

Change time signature.....280

channel mapper.....142

channel routing.....329

channel routing/mixing plug-ins.....334

channel splitting.....207

Channel Splitting.....186

channels.....331

chord notation.....287

chromatic MIDI item, creating.....183

chromatic midi, using.....183

Clean Current Project Directory.....440

clef.....278

Click Source, inserting.....365

client, REAPER to sequencer.....446

color, customizing.....211

color, set tracks to custom.....94

color, set tracks to random.....94

Commands.....17

comp sets, recalling.....157

comp sets, saving.....157

comping.....165

Compression.....319

compression, dynamic.....379

configuration, export.....418

configuration, import.....418

Consolidating a project.....402

Context Menus.....17

continuous scroll.....29, 426

control change messages.....235

Control Channel Editing.....236

control surface.....222

Control Surface, installing.....22

control surface, setting up.....311

control surface, using.....311

Controls.....17

copying envelopes with media items.....360

CPU usage.....423

create new project.....27

Creating tracks.....57

crescendo.....281

Crop Project to Selection.....209

crossfade actions.....145

Crossfade Editor.....143

Crossfade Editor (see Chapter 7).....156

crossfades.....134

Crossfades.....64

cursor behaviour.....432

custom actions, creating.....297

custom actions, using.....298

custom colors.....430

Custom Splash Screen.....442

custom toolbar, dock/undock.....308

D

databases.....82

Delay.....317

deleted items, removing.....440

delta solo.....330

Desktop Icon.....16

Detector Input.....331

diminuendo.....281

dither.....404

Docker.....51

Docker, detaching.....51

dockers, multiple.....224

Docking.....51

download REAPER.....15

dry run.....405

Ducking.....330

DVD Audio.....407

DVD Audio Soundtrack.....407

dynamic compression.....379

Dynamic split.....180, 181

Dynamic Split.....190

Dynamic Splitting.....148

E

edit behavior.....432

Editing Behavior Preferences.....432

Editing Items.....121

Editing settings.....121

editing, trim content behind media item...135

Editor.....272

Embed tempo.....403

Empty Events.....67

Empty Item.....67

Empty MIDI item, creating.....232

Enabling plug-ins.....23

envelope button.....347

envelope display.....433

envelope lanes.....347

envelope panel.....352

Up and Running: A REAPER User Guide v 7.31

O	
OGG Vorbis.....	30
oop recording settings.....	426
Opacity.....	51
Open file, FX set off line.....	40
Open ifile n new project tab.....	53
Open Items with Editor.....	121
Open project.....	53
Open Project.....	29
ornamentation.....	286
OSC (Open Sound Control).....	311
Output A.....	95
Output Aliasing.....	21
output FX monitoring.....	116
Output, recording.....	69
Overdubbing.....	62
overlapped items.....	134
P	
Pan controls.....	33
pan law.....	31, 34
pan mode.....	34
pan modes.....	205
pan track, MIDI.....	33
panic button.....	248
parallel FX.....	114, 332
Parameter modulation.....	373
parameter modulation, linking parameters	380
peak levels, reset on VU meters.....	314
peaks.....	149
peaks/waveforms.....	429
peaks/waveforms preferences.....	430
pencil mode.....	136
performance meter.....	441
Performance Meter.....	43, 423
phase control.....	33
Phase Control.....	34
phrase.....	286
Piano Roll.....	244, 252
pin connector.....	142, 329
pitch correction.....	188
Pitch Correction.....	188
pitch correction, automatic.....	188
pitch correction, manual.....	188
pitch envelope.....	186
pitch manipulation.....	186
pitch shift.....	133, 185
pitch shift plug-ins.....	186
pitch shift, MIDI controlled.....	264
pitch shifting.....	186
Pitch, changing.....	185
pitch, preserve in audio items.....	185
play cursor, managing.....	42
play loop selection.....	46
play rate, adjusting for project.....	185
Play Speed envelope.....	365
Play Speed, automation.....	365
playback preferences.....	426
playback rate.....	132
Playback rate.....	132
Playback Rate, multiple items.....	187
Playback Rate, single item.....	187
plug-in delay compensation.....	116
Plug-in Essentials.....	315
plug-in settings.....	438
plug-in, noise reduction.....	323
Plug-ins.....	
Saving Presets.....	70
plug-ins preferences.....	438
plug-ins, compatibility.....	328
Plug-ins, enabling.....	23
plug-ins, MIDI.....	263
Plug-ins, ReWire/DX.....	440
pops and clicks.....	28, 62
Pre-fader track metering.....	33
pre-roll.....	63
Preferences.....	20, 21
Preferences, appearance.....	427
Preferences, editing behavior.....	432
Preferences, envelopes.....	433
Preferences, General.....	29
Preferences, MIDI.....	437
Preferences, playback.....	426
Preferences, plug-ins.....	438
Preferences, Project.....	419
Preferences, Project Defaults.....	432
preferences, searching.....	93
Preferences, VU meters.....	430
Presence Range.....	316
Preserve Pitch.....	187
preset, save as default.....	319
Presets.....	319
Preview Keyboard.....	246
preview media item peaks.....	74
project file association.....	224
Project File Path.....	30
project files, multiple versions.....	224
project length.....	31
project management.....	440
Project Media/FX Bay.....	211
project p.....	419
Project Preferences.....	55
Project rendering.....	403
Project Sample Rate.....	30
Project Settings.....	30, 176
Project Tabs.....	52
project tabs, multiple.....	52
Project Template.....	61
Project Time Base, changing.....	31
project versions.....	226
prompt to save.....	74
punch recording.....	63
Punch Recording.....	62, 63
Q	
quantize.....	180
Quantize.....	242, 251, 257
Quantize events.....	251, 257
Quantize selected events.....	252
Quantize strength.....	251
Quantize track MIDI recording.....	252
R	
Ratio.....	319
raw MIDI data.....	244
razor editing.....	123, 366
razor edits.....	123
ReaComp.....	320
ReaComp compressor.....	330
ReaDelay.....	317
ReaFir.....	323
ReaGate.....	321
ReaMote Client.....	28
Reaper File Types.....	28
REAPER Options.....	442
REAPER Selections.....	17
REAPER Uninstall.....	28
reaper-dxplug-ins.ini.....	25
reaper-vstplug-ins.ini.....	25
reaper.ini.....	25
ReaPitch.....	186, 187
ReaRoute.....	443
ReaRoute ASIO driver.....	443
ReaRoute, sending audio into Sonar.....	444
ReaRoute, setting up apps.....	443
ReaRoute, with Ableton Live.....	443
ReaSamplomatic.....	335
ReaScript.....	446
ReaSurround.....	338, 339
ReaSurroundPan.....	338, 340
ReaSynth.....	70
ReaTune.....	188, 326
ReaVoice.....	264
ReaXComp.....	324
Receive levels.....	42
Receives.....	46, 69, 338
Recent Projects.....	29
Record.....	58
record additional items.....	67
Record Arm.....	57, 58
record arm, automatic.....	59
Record mode.....	57
Record Multiple Tracks.....	58
Recording format.....	30
recording formats, mixed.....	75
recording on the fly.....	58
Recording output.....	69
Recording Preferences.....	74
recording with a virtual instrument.....	71
recording, default track settings.....	75
recovery mode.....	117
redo, store multiple paths.....	441
region.....	63
region, coloring.....	173
Region/Marker Manager.....	174
regions.....	409
Regions, creating.....	173
Regions, locking.....	210
regions, rendering.....	404
Registry.....	24
relative edge fading.....	143
relative pathnames.....	419
Release.....	321
Render items.....	159
Render multichannel tracks.....	407
Render selected tracks to stem tracks.....	416
Render stems.....	407
render time range.....	404
Render to File dialog box.....	403
Rendering.....	403
rendering a finished song.....	408
rendering preferences.....	427
rendering, surround format.....	415
reset configuration to factory defaults.....	27
resetting REAPER settings.....	53
Reverse items.....	160
reverse media item.....	133
Rewire.....	342
ReWire.....	263
ReWire client mode.....	27
ReWire.....	342
ReWire, REAPER as client.....	342
ReWire, REAPER as host.....	342
ReWire/DX.....	440
REX files.....	184
Ripple Editing.....	137
round-robin.....	335
routing.....	336
Routing.....	46
Routing Examples.....	329
Routing Interface.....	337
Routing Ma.....	47

Index

Routing Matrix.....58, 99, 337
Routing Window.....337
routing, drag and drop.....47
RPP Files.....16
rumble or hum removal.....323

S

sample file.....336
Samples.....44
samples, saving.....183
Save new version of project.....226
Save Project.....56
Scale Finder.....265
Scale UI Elements.....442
Screen Set.....218
Screen Sets.....218, 219, 220
screen sets, auto-saving changes.....220
Screen Sets, Windows.....219
scripts.....298
scripts, importing.....298
scroll track view.....74
Scroll Wheel.....33
scroll, continuous.....29, 426
Scrolling.....35
scrub.....193, 248
scrub settings.....193
scrubbing.....32
Scrubbing.....193
Seconds.....44
Seek playback when clicked.....42
Send Master/Parent.....97
send types.....329
Send, creating.....41
Sends.....41, 46, 96, 338
Sends default settings.....421
sends, adding to Mixer.....202
sequencer baby.....266
Set Time Signature.....192
Show All Takes In Lane.....156
Show All Takes in Lanes.....65, 66
Show audio configuration on startup.....27
Show audio hardware as sources.....96
Show Big Clock.....54
Show Navigator.....36
Show Screen Sets.....218
Show Transport.....32
sidechaining.....330, 373
silent passages, removing.....148
skip time selection.....46
Slip Editing.....134
slip-edit.....134
slur.....286
smart tools.....309
Smooth seek.....425
SMPTE.....445
SMPTE timecode generator.....445
Snap Distance.....140
Snap offset.....132
Snap to Grid.....139
snap to marker.....171
Snap/Grid Settings.....139
soft takeover.....223
Software Updates.....17
Solo.....33
Solo In Front.....93
sound card.....422
Sound Shaping.....315
Sound Shaping Plug-ins.....316
Source Media Bay.....214
Source Properties.....139
spectral display.....150

spectral edits.....152, 153
spectral peaks.....150
spectrogram.....152
Split Events.....242, 246
SPP Send.....445
staff notation.....271
Start Menu Shortcuts.....16
Starting REAPER.....17
Stem Rendering.....416
Step Sequencer.....244
Stereo to Mono conversion.....142
stereo track, recording.....60
Stereo, reversing.....142
Stretch markers.....188
submix, rendering.....408
subprojects.....226, 228, 229
subprojects.....226
Surround panner.....338
swing grid.....139
SWS Extensions.....222
Sync piano roll view to project.....266
sync to external device.....445
synchronize external device to REAPER.....445
Synchronous FX multiprocessing.....116
Synthesizer.....70
SysEx messages.....238
System tweaks.....442

T

Take command.....66
take marker.....160
take markers.....160
Take, next.....66
Take, previous.....66
takes, arranging.....155
takes, color coded.....65
takes, editing.....155
takes, envelopes.....363
takes, explode in place.....156
takes, explode to tracks.....155
Takes, Explode to tracks.....66
takes, imploding.....159
takes, propagating.....159
Takes, Slice and Dice.....156
TCP settings.....431
template.....419
Template, Project.....61
template, set default.....419
Template, Track.....61
tempo detection.....179
Tempo Map Envelope.....365
Text Events.....238
The Install Options.....16
the Microsoft GS Wavetable Synth.....72
theme, modifying.....211
Threshold.....319, 321
Time Based Effects.....317
time selection.....134
time selection recording.....62
time selection recording, looped.....72
Time Selection, keyboard shortcuts.....45
time selection, link to loop points.....134
time selection, modifying.....45
Time Signature Marker.....191
time signature marker, inserting.....183
time stretch.....133
Time Stretching.....187
Time-Based Effects.....315
timebase.....30
timecode, inserting.....445

timecodes, negative.....192
timeline.....192
Timeline.....44
timeline: set units.....44
toolbar.....107
Toolbar.....18
toolbar docker.....310
toolbar, custom.....35, 305, 306
toolbar, custom envelope.....360
Toolbars.....17
toolbars, custom.....308
Toolbars, customizing.....289
toolbars, exporting.....307
toolbars, floating.....308
toolbars, importing.....307
Touch.....351
Track Channels.....337
track color.....217
track color options.....94
Track Control Modifiers.....92
track control panel help.....224
Track Controls.....33
track controls, lock.....35
Track default settings.....421
Track FX.....37, 109
Track FX Order.....39
Track FX parameters.....39
track group edits.....129
track group manager.....128
track grouping.....100, 126, 130
track grouping controls.....104
track grouping global.....101
Track Manager.....216
track meter.....94
track pan, using for MIDI.....33
Track Panel Width.....34
Track Panels.....18
Track Performance Options.....116
track routing.....329
Track Routing.....46
Track Template, Inserting.....61
track templates.....223, 357
Track Templates.....61
Track View screen sets.....218
Track Views.....218
track volume, using for MIDI.....33
Track volume/pan, link to MIDI.....92
track wiring.....49
Track, Add New Track.....41
Track, copy.....48, 91
Track, delete.....48, 91
Track, move.....48, 91
Track/Send Defaults.....421
tracks, freeze/unfreeze.....117
transient detection sensitivity.....126
transient detection settings.....179, 432
transient guides.....189
transient, extend selection to.....179
transients.....178
transients guides.....149
Transport Bar.....32
Transport Bar, dock/undock.....32
transpose MIDI.....243, 257
transpose MIDI notes.....248, 257, 259
tremolo.....286
trill.....286
Trim content behind media items.....135
Trim Items to Selected Area.....138
tuning an instrument.....326
tuplet.....285

Up and Running: A REAPER User Guide v 7.31

U			
UAD plug-ins.....	116	video processing hierarchy.....	392
UI Tweaks.....	442	video project, rendering.....	415
Undo.....	51, 63	video signal attributes.....	397
Undo History Window.....	51	video soundtrack.....	389
Undo History, load with project file.....	441	video tracks.....	392
Undo History, save with project file.....	52, 441	Video Window.....	389
Undo storage area.....	52	video workflow.....	399
Undo/redo paths, save multiple.....	52	virtual instrument, recording with.....	71
unfreeze tracks.....	117, 217	Virtual MIDI Keyboard.....	70, 335
Uninstall REAPER.....	27	virtual spacer.....	36
Uninstalling Reaper.....	28	voice.....	284, 285
Unquantize.....	252	Volume controls.....	33
Upper Mid Range.....	316	Volume Controls.....	92
USB flash device.....	26	volume envelope scaling.....	356
		volume fader default gain.....	421
		volume track, MIDI.....	33
V		VST.....	439
VCA grouping.....	105, 106	VST folders.....	111
Velocity Handles.....	245	VST plug-in, generic interface.....	328
Vertical Scroll.....	35	VST plug-ins.....	23, 315
Vertical Zoom.....	35	VST Plug-ins, Auto detect.....	23
video codecs.....	397	VSTi patch/bank files.....	70
video container files.....	397	VU meter preferences.....	430
video effects.....	391	VU meters, reset peaks.....	314
video item properties.....	390		
		W	
		WASAPI drivers.....	78
		WAV format.....	407
		Web Audio.....	407
		web browser interface!.....	313
		Window screen sets.....	218
		Window Views.....	219
		Windows Registry.....	24
		Windows Start Menu.....	27
		Write Automation.....	348
		X	
		Xenakios Extensions.....	222
		Y	
		yric.....	282
		Z	
		Zoom Selection.....	35, 44, 171, 209
		Zoom to Time Selection.....	45
		Zooming.....	34, 35, 49
		routing.....	262